

Quick setup guide

Pressure transmitter with metallic measuring cell

VEGABAR 83

Secondary sensor for electronic differential pressure

With SIL qualification



Document ID: 48052



VEGA

Contents

- 1 For your safety 3**
 - 1.1 Authorised personnel 3
 - 1.2 Appropriate use..... 3
 - 1.3 Warning about incorrect use..... 3
 - 1.4 General safety instructions 3
 - 1.5 Conformity..... 3
 - 1.6 SIL qualification according to IEC 61508..... 4
- 2 Product description 5**
 - 2.1 Configuration..... 5
- 3 Mounting 6**
 - 3.1 General instructions for use of the instrument 6
 - 3.2 Ventilation and pressure compensation..... 6
 - 3.3 Combination Primary/Secondary sensor..... 6
- 4 Connecting to power supply..... 9**
 - 4.1 Connecting..... 9
 - 4.2 Single chamber housing..... 10
 - 4.3 Connection example 10
- 5 Set up with the display and adjustment module 12**
 - 5.1 Parameter adjustment 12
 - 5.2 Menu overview 14
- 6 Supplement 17**
 - 6.1 Technical data 17



Information:

This quick setup guide enables quick setup and commissioning of your instrument.

You can find supplementary information in the corresponding, more detailed Operating Instructions Manual as well as the Safety Manual that comes with instruments with SIL qualification. These manuals are available on our homepage.

Operating instructions VEGABAR 83 - Secondary sensor for electronic differential pressure with SIL qualification: Document-ID 48047

Safety Manual VEGABAR series 80 - Two-wire 4 ... 20 mA/HART with SIL qualification: Document-ID 48369

Editing status of the quick setup guide: 2023-09-06

1 For your safety

1.1 Authorised personnel

All operations described in this documentation must be carried out only by trained and authorized personnel.

During work on and with the device, the required personal protective equipment must always be worn.

1.2 Appropriate use

As Secondary Device, the VEGABAR 83 is part of an electronic differential pressure measurement.

You can find detailed information about the area of application in chapter " *Product description*".

Operational reliability is ensured only if the instrument is properly used according to the specifications in the operating instructions manual as well as possible supplementary instructions.

1.3 Warning about incorrect use

Inappropriate or incorrect use of this product can give rise to application-specific hazards, e.g. vessel overfill through incorrect mounting or adjustment. Damage to property and persons or environmental contamination can result. Also, the protective characteristics of the instrument can be impaired.

1.4 General safety instructions

This is a state-of-the-art instrument complying with all prevailing regulations and directives. The instrument must only be operated in a technically flawless and reliable condition. The operating company is responsible for the trouble-free operation of the instrument. When measuring aggressive or corrosive media that can cause a dangerous situation if the instrument malfunctions, the operating company has to implement suitable measures to make sure the instrument is functioning properly.

The safety instructions in this operating instructions manual, the national installation standards as well as the valid safety regulations and accident prevention rules must be observed.

For safety and warranty reasons, any invasive work on the device beyond that described in the operating instructions manual may be carried out only by personnel authorised by us. Arbitrary conversions or modifications are explicitly forbidden. For safety reasons, only the accessory specified by us must be used.

To avoid any danger, the safety approval markings and safety tips on the device must also be observed.

1.5 Conformity

The device complies with the legal requirements of the applicable country-specific directives or technical regulations. We confirm conformity with the corresponding labelling.

The corresponding conformity declarations can be found on our homepage.

Due to the design of its process fittings, the device does not subject of EU pressure device directive if it is operated at process pressures ≤ 200 bar. ¹⁾

1.6 SIL qualification according to IEC 61508

The Safety Integrity Level (SIL) of an electronic system is used to assess the reliability of integrated safety functions.

For detailed specification of the safety requirements, multiple SIL levels are specified according to safety standard IEC 61508. You can find detailed information in chapter " *Functional safety (SIL)*" of the operating instructions.

The instrument meets the specifications of IEC 61508: 2010 (Edition 2). It is qualified for single-channel operation up to SIL2. The instrument can be used homogeneously redundant up to SIL3 in multi-channel architecture with HFT 1.

¹⁾ Exception: Versions with measuring ranges from 250 bar. These are subject of the EU Pressure Device Directive.

2 Product description

2.1 Configuration

Type label

The type label contains the most important data for identification and use of the instrument:

- Instrument type
- Information about approvals
- Configuration information
- Technical data
- Serial number of the instrument
- QR code for device identification
- Numerical code for Bluetooth access (optional)
- Manufacturer information

Documents and software

To find order data, documents or software related to your device, you have the following options:

- Move to "www.vega.com" and enter in the search field the serial number of your instrument.
- Scan the QR code on the type label.
- Open the VEGA Tools app and enter the serial number under "**Documentation**".

3 Mounting

Protection against moisture

3.1 General instructions for use of the instrument

Protect your instrument against moisture ingress through the following measures:

- Use a suitable connection cable (see chapter "Connecting to power supply")
- Tighten the cable gland or plug connector
- Lead the connection cable downward in front of the cable entry or plug connector

This applies mainly to outdoor installations, in areas where high humidity is expected (e.g. through cleaning processes) and on cooled or heated vessels.



Note:

Make sure that during installation or maintenance no moisture or dirt can get inside the instrument.

To maintain the housing protection, make sure that the housing lid is closed during operation and locked, if necessary.

Filter element - Position

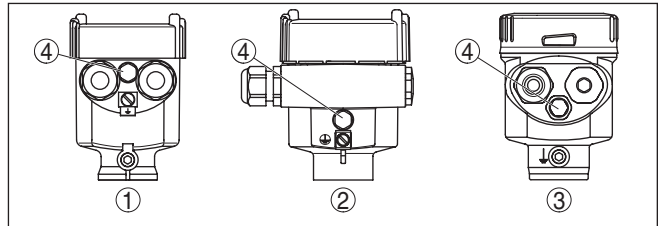

Fig. 1: Position of the filter element - non-Ex, Ex ia version

- 1 Plastic, stainless steel housing (precision casting)
- 2 Aluminium housing
- 3 Stainless steel housing (electropolished)
- 4 Filter element

With the following instruments a blind plug is installed instead of the filter element:

- Instruments in protection IP66/IP68 (1 bar) - ventilation via capillaries in non-detachable cable
- Instruments with absolute pressure

3.3 Combination Primary/Secondary sensor

In principle, any sensor combination within the instrument series is allowed. The following requirements must be fulfilled:

- Configuration of the sensor suitable for electronic differential pressure
- Pressure type is identical for both sensors, i.e. relative pressure/relative pressure or absolute pressure/absolute pressure

- Primary Device measures the higher pressure
- Measurement setup as shown in the following chapters

The measuring range of each sensor is selected such that it fits the measuring loop. For this, the max. recommended turn down must be noted. See chapter " *Technical data*". It is absolutely necessary the the measuring ranges of Primary and Secondary Device correspond.

Measurement result = Measured value of Primary (total pressure) - measured value of Secondary (static pressure)

Depending on the application, individual combinations can result, see following examples:

Example - large vessel

Data

Application: Level measurement

Medium: Water

Vessel height: 12 m, hydrostatic pressure = $12 \text{ m} \times 1000 \text{ kg/m}^3 \times 9.81 \text{ m/s}^2 = 117.7 \text{ kPa} = 1.18 \text{ bar}$

Superimposed pressure: 1 bar

Total pressure: $1.18 \text{ bar} + 1 \text{ bar} = 2.18 \text{ bar}$

Instrument selection

Nominal measuring range Primary: 2.5 bar

Nominal measuring range Secondary: 1 bar

Turn Down: $2.5 \text{ bar} / 1.18 \text{ bar} = 2.1 : 1$

Example - small vessel

Data

Application: Level measurement

Medium: Water

Vessel height: 500 mm, hydrostatic pressure = $0.50 \text{ m} \times 1000 \text{ kg/m}^3 \times 9.81 \text{ m/s}^2 = 4.9 \text{ kPa} = 0.049 \text{ bar}$

Superimposed pressure: 350 mbar = 0.35 bar

Total pressure: $0.049 \text{ bar} + 0.35 \text{ bar} = 0.399 \text{ bar}$

Instrument selection

Nominal measuring range Primary: 0.4 bar

Nominal measuring range Secondary: 0.4 bar

Turn Down: $0.4 \text{ bar} / 0.049 \text{ bar} = 8.2 : 1$

Example - orifice in pipeline

Data

Application: Differential pressure measurement

Medium: Gas

Static pressure: 0.8 bar

Differential pressure on orifice: 50 mbar = 0.050 bar

Total pressure: $0.8 \text{ bar} + 0.05 \text{ bar} = 0.85 \text{ bar}$

Instrument selection

Nominal measuring range Primary: 1 bar

Nominal measuring range Secondary: 1 bar

Turn Down: $1 \text{ bar} / 0.050 \text{ bar} = 20 : 1$

Output measured values The measuring result (level, pressure difference) as well as measured value Secondary (static or superimposed pressure) are output by the sensor. Depending on the instrument version, output as 4 ... 20 mA signal or digitally via HART, Profibus PA or Foundation Fieldbus.

4 Connecting to power supply

4.1 Connecting

Connection technology

The connection to the Primary Device is carried out through spring-loaded terminals in the respective housing. For this, use the supplied, confectioned cable. Solid cores as well as flexible cores with cable end sleeves are inserted directly into the terminal openings.

In case of flexible cores without end sleeves, press the terminal from above with a small screwdriver, the terminal opening is then free. When the screwdriver is released, the terminal closes again.



Information:

The terminal block is pluggable and can be removed from the electronics. To do this, lift the terminal block with a small screwdriver and pull it out. When reinserting the terminal block, you should hear it snap in.

You can find further information on the max. wire cross-section under "*Technical data - Electromechanical data*".

Connection procedure

Proceed as follows:

1. Unscrew the housing lid
2. Loosen compression nut of the cable gland and remove blind plug
3. Remove approx. 10 cm (4 in) of the cable mantle, strip approx. 1 cm (0.4 in) insulation from the individual wires or use supplied connection cable
4. Insert the cable into the sensor through the cable entry



Fig. 2: Connection steps 5 and 6

5. Insert the wire ends into the terminals according to the wiring plan
6. Check the hold of the wires in the terminals by lightly pulling on them

7. Connect the shielding to the internal ground terminal, connect the external ground terminal to potential equalisation
 8. Tighten the compression nut of the cable entry gland. The seal ring must completely encircle the cable
 9. Unscrew the blind plug on the Primary, screw in the supplied cable gland
 10. Connection cable to Primary, see steps 3 to 8
 11. Screw the housing lid back on
- The electrical connection is finished.

4.2 Single chamber housing



The following illustration applies to the non-Ex, Ex ia and Ex d ia version.

Electronics and connection compartment

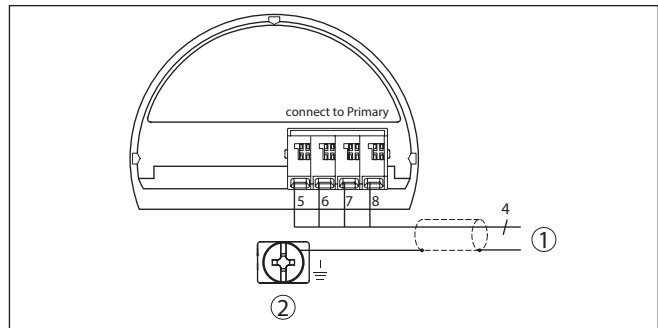

Fig. 3: Wiring plan VEGABAR 83 Secondary Device

- 1 To the Primary Device
- 2 Ground terminal for connection of the cable screening²⁾

4.3 Connection example

Connection example, electronic differential pressure

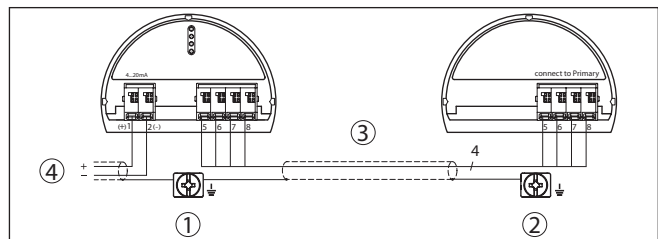

Fig. 4: Connection example, electronic differential pressure

- 1 Primary Device
- 2 Secondary Device
- 3 Connection cable
- 4 Supply and signal circuit Primary Device

²⁾ Connect shielding here. Connect ground terminal on the outside of the housing to ground as prescribed. The two terminals are galvanically connected.

The connection between Primary and Secondary Device is carried out acc. to the table:

Primary Device	Secondary Device
Terminal 5	Terminal 5
Terminal 6	Terminal 6
Terminal 7	Terminal 7
Terminal 8	Terminal 8

5 Set up with the display and adjustment module

5.1 Parameter adjustment

Operating sequence

A parameter change with SIL qualified instruments must always be carried out as follows:

- Unlock adjustment
- Change parameters
- Lock adjustment and verify modified parameters

This ensures that all modified parameters have been deliberately changed.

Unlock adjustment

The instrument is shipped in locked condition.

To prevent unintentional or unauthorized adjustment, the instrument is protected (locked) against all parameter changes while in normal operating condition.

For each parameter change you have to enter the PIN of the instrument. In delivery status, the PIN is "0000".



Change parameters

You can find a description below the respective parameter.

Lock adjustment and verify modified parameters

You can find a description below the parameter "Setup - Lock adjustment".

- Change setup parameters** 1. Go to the menu "Setup" via the display and adjustment module.

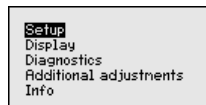

2. In this menu item you activate/deactivate the Secondary sensor for electronic differential pressure and select the application, e.g. level

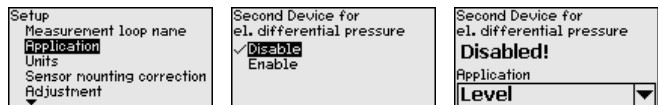

3. Select in the menu item "Units" the adjustment unit of the instrument, e.g. "bar".

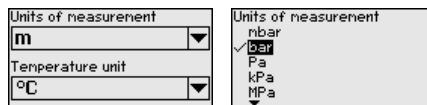

4. Depending on the application, carry out the adjustment e.g. in the menu items "Min. adjustment" and "Max. adjustment".

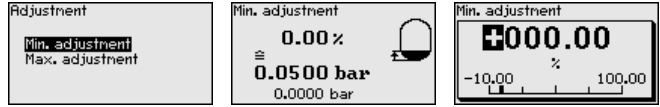

Parameterization example VEGABAR 83 always measures pressure independently of the process variable selected in the menu item "Application". To output the selected process variable correctly, an allocation of the output signal to 0 % and 100 % must be carried out (adjustment).

With the application "Level", the hydrostatic pressure, e.g. with full and empty vessel, is entered for adjustment. A superimposed pressure is detected by the Secondary sensor and automatically compensated. See the following example:

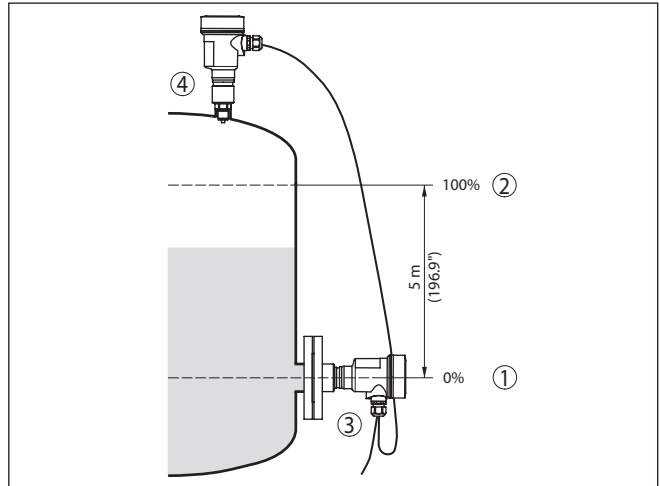

Fig. 5: Parameter adjustment example Min./max. adjustment, level measurement

- 1 Min. level = 0 % corresponds to 0.0 mbar
- 2 Max. level = 100 % corresponds to 490.5 mbar
- 3 VEGABAR 83
- 4 VEGABAR 83, Secondary sensor

If these values are not known, an adjustment with filling levels of e.g. 10 % and 90 % is also possible. By means of these settings, the real filling height is then calculated.

The actual product level during this adjustment is not important, because the min./max. adjustment is always carried out without changing the product level. These settings can be made ahead of time without the instrument having to be installed.

Lock adjustment

With this menu item you safeguard the sensor parameters against unauthorized or unintentional modifications.

SIL To detect parameterization errors reliably, safety-relevant parameters must be verified before saving them into the instrument.

1. Enter PIN

In delivery status, the PIN is "0000".

2. Character string comparison

You then have to carry out the character string comparison. This is used to check the character presentation.

3. Serial number acknowledgement

Afterwards you confirm that the serial number of your instrument was carried over correctly. This is used to check device communication.

4. Verify parameters

Confirm the modified values one after the other.

If the described process of parameter adjustment was run through completely and correctly, the instrument will be locked and hence ready for operation.

5.2 Menu overview

The following tables show the adjustment menu of the instrument. Depending on the instrument version or application, all menu items may not be available or some may be differently assigned.



Note:

You can find further menu items in the operating instructions of the respective Primary Device.

Setup

Menu item	Parameter	Default setting
Measurement loop name	19 alphanumeric characters/special characters	Sensor
Application (SIL)	Level, process pressure	Level
	Secondary Device for electronic differential pressure ³⁾	Deactivated
Units	Adjustment unit (m, bar, Pa, psi ... user-defined)	mbar (with nominal measuring range ≤ 400 mbar) bar (with nominal measuring ranges ≥ 1 bar)
	Static pressure	bar
Position correction (SIL)		0.00 bar

³⁾ Parameter active, when Secondary Device is connected

Menu item	Parameter	Default setting
Adjustment (SIL)	Distance (with density and interface)	1.00 m
	Zero/Min. adjustment	0.00 bar 0.00 %
	Span/Max. adjustment	Nominal measuring range in bar 100.00 %
Damping (SIL)	Integration time	0.0 s
Linearization (SIL)	Linear, cylindrical tank, ... user-defined	Linear
Current output (SIL)	Current output - Mode	Output characteristics 4 ... 20 mA Reaction when malfunctions occur ≤ 3.6 mA
	Current output - Min./Max.	3.8 mA 20.5 mA
Lock adjustment (SIL)	Blocked, released	Last setting

Display

Display

Menu item	Default value
Menu language	Selected language
Displayed value 1	Pressure
Displayed value 2	Ceramic measuring cell: Measuring cell temperature in °C Metallic measuring cell: Electronics temperature in °C
Display format	Number of positions after the decimal point, automatically
Backlight	Switched on

Diagnostics

Menu item	Parameter	Default setting
Device status		-
Peak indicator	Pressure	Current pressure measured value
Peak indicator temp.	Temperature	Actual measuring cell and electronic temperature
Simulation		-

Additional adjustments

Menu item	Parameter	Default setting
PIN		0000
Date/Time		Actual date/Actual time

Menu item	Parameter	Default setting
Copy instrument settings		-
Special parameters		No reset
Scaling	Scaling size	Volume in l
	Scaling format	0 % corresponds to 0 l 100 % corresponds to 0 l
Current output	Current output - Meas. variable	Lin. percent - Level
	Current output - Adjustment	0 ... 100 % correspond to 4 ... 20 mA
HART mode		Address 0
DP flow element	Unit	m ³ /s
	Adjustment	0.00 % correspond to 0.00 m ³ /s 100.00 %, 1 m ³ /s

Info

Menu item	Parameter
Device name	VEGABAR 83
Instrument version	Hardware and software version
Factory calibration date	Date
Sensor characteristics	Order-specific characteristics

6 Supplement

6.1 Technical data

Note for approved instruments

The technical data in the respective safety instructions which are included in delivery are valid for approved instruments (e.g. with Ex approval). These data can differ from the data listed herein, for example regarding the process conditions or the voltage supply.

All approval documents can be downloaded from our homepage.

Electromechanical data - version IP66/IP67 and IP66/IP68 (0.2 bar)⁴⁾

Options of the cable entry

- Cable entry M20 x 1.5; ½ NPT
- Cable gland M20 x 1.5; ½ NPT (cable ø see below table)
- Blind plug M20 x 1.5; ½ NPT
- Closing cap ½ NPT

Material cable gland/Seal insert	Cable diameter			
	5 ... 9 mm	6 ... 12 mm	7 ... 12 mm	10 ... 14 mm
PA/NBR	√	√	-	√
Brass, nickel-plated/NBR	√	√	-	-
Stainless steel/NBR	-	-	√	-

Wire cross-section (spring-loaded terminals)

- Massive wire, stranded wire 0.2 ... 2.5 mm² (AWG 24 ... 14)
- Stranded wire with end sleeve 0.2 ... 1.5 mm² (AWG 24 ... 16)

Interface to the Primary Device

Data transmission Digital (I²C-Bus)

Connection cable Secondary - Primary, mechanical data

- Configuration Cores, strain relief, braided, metal foil, jacket
- Standard length 5 m (16.40 ft)
- Max. length 70 m (229.7 ft)
- Min. bending radius (at 25 °C/77 °F) 25 mm (0.985 in)
- Diameter approx. 8 mm (0.315 in), approx. 6 mm (0.236 in)
- Material PE, PUR
- Colour Black, blue

Connection cable Secondary - Primary, electrical data

- Wire cross-section 0.34 mm² (AWG 22)
- Wire resistance < 0.05 Ω/m (0.015 Ω/ft)

⁴⁾ IP66/IP68 (0.2 bar), only with absolute pressure.

Voltage supply for the complete system through Primary Device

Operating voltage

- | | |
|------------------------------------------|-------------------------------------------------------------------|
| - $U_{B\ min}$ | 12 V DC |
| - $U_{B\ min}$ with lighting switched on | 16 V DC |
| - $U_{B\ max}$ | Depending on the signal output and version of the Primary Devices |



Printing date:

VEGA

All statements concerning scope of delivery, application, practical use and operating conditions of the sensors and processing systems correspond to the information available at the time of printing.

Subject to change without prior notice

© VEGA Grieshaber KG, Schiltach/Germany 2023



48052-EN-230914

VEGA Grieshaber KG
Am Hohenstein 113
77761 Schiltach
Germany

Phone +49 7836 50-0
E-mail: info.de@vega.com
www.vega.com