

# Quick setup guide

Pressure transmitter with metallic measuring cell

## VEGABAR 81

Secondary sensor for electronic differential pressure



Document ID: 46331



**VEGA**

# Contents

- 1 For your safety ..... 3**
  - 1.1 Authorised personnel ..... 3
  - 1.2 Appropriate use..... 3
  - 1.3 Warning about incorrect use..... 3
  - 1.4 General safety instructions ..... 3
  - 1.5 Conformity..... 3
  - 1.6 Environmental instructions ..... 4
- 2 Product description ..... 5**
  - 2.1 Configuration..... 5
- 3 Mounting ..... 6**
  - 3.1 General instructions for use of the instrument ..... 6
  - 3.2 Ventilation and pressure compensation..... 6
  - 3.3 Combination Primary/Secondary sensor..... 6
- 4 Connecting to power supply..... 9**
  - 4.1 Connecting..... 9
  - 4.2 Single chamber housing..... 10
  - 4.3 Connection example ..... 10
- 5 Set up with the display and adjustment module ..... 12**
  - 5.1 Parameter adjustment - Quick setup ..... 12
  - 5.2 Parameter adjustment - Extended adjustment..... 16
  - 5.3 Menu overview ..... 17
- 6 Supplement ..... 20**
  - 6.1 Technical data ..... 20



**Information:**

This quick setup guide enables quick setup and commissioning of your instrument.

You can find supplementary information in the corresponding, more detailed Operating Instructions Manual as well as the Safety Manual that comes with instruments with SIL qualification. These manuals are available on our homepage.

**Operating instructions VEGABAR 81 - Secondary sensor for electronic differential pressure: Document-ID 45049**  
 Editing status of the quick setup guide: 2023-09-06

# 1 For your safety

## 1.1 Authorised personnel

All operations described in this documentation must be carried out only by trained and authorized personnel.

During work on and with the device, the required personal protective equipment must always be worn.

## 1.2 Appropriate use

As Secondary Device, the VEGABAR 81 is part of an electronic differential pressure measurement.

You can find detailed information about the area of application in chapter " *Product description*".

Operational reliability is ensured only if the instrument is properly used according to the specifications in the operating instructions manual as well as possible supplementary instructions.

## 1.3 Warning about incorrect use

Inappropriate or incorrect use of this product can give rise to application-specific hazards, e.g. vessel overfill through incorrect mounting or adjustment. Damage to property and persons or environmental contamination can result. Also, the protective characteristics of the instrument can be impaired.

## 1.4 General safety instructions

This is a state-of-the-art instrument complying with all prevailing regulations and directives. The instrument must only be operated in a technically flawless and reliable condition. The operating company is responsible for the trouble-free operation of the instrument. When measuring aggressive or corrosive media that can cause a dangerous situation if the instrument malfunctions, the operating company has to implement suitable measures to make sure the instrument is functioning properly.

The safety instructions in this operating instructions manual, the national installation standards as well as the valid safety regulations and accident prevention rules must be observed.

For safety and warranty reasons, any invasive work on the device beyond that described in the operating instructions manual may be carried out only by personnel authorised by us. Arbitrary conversions or modifications are explicitly forbidden. For safety reasons, only the accessory specified by us must be used.

To avoid any danger, the safety approval markings and safety tips on the device must also be observed.

## 1.5 Conformity

The device complies with the legal requirements of the applicable country-specific directives or technical regulations. We confirm conformity with the corresponding labelling.

The corresponding conformity declarations can be found on our homepage.

Due to the design of its process fittings, the device does not subject of EU pressure device directive if it is operated at process pressures  $\leq 200$  bar. <sup>1)</sup>

## 1.6 Environmental instructions

Protection of the environment is one of our most important duties. That is why we have introduced an environment management system with the goal of continuously improving company environmental protection. The environment management system is certified according to DIN EN ISO 14001.

Please help us fulfil this obligation by observing the environmental instructions in this manual:

- Chapter " *Packaging, transport and storage* "
- Chapter " *Disposal* "

<sup>1)</sup> Exception: Versions with measuring ranges from 250 bar. These are subject of the EU Pressure Device Directive.

## 2 Product description

### 2.1 Configuration

#### Type label

The type label contains the most important data for identification and use of the instrument:

- Instrument type
- Information about approvals
- Configuration information
- Technical data
- Serial number of the instrument
- QR code for device identification
- Numerical code for Bluetooth access (optional)
- Manufacturer information

#### Documents and software

To find order data, documents or software related to your device, you have the following options:

- Move to "[www.vega.com](http://www.vega.com)" and enter in the search field the serial number of your instrument.
- Scan the QR code on the type label.
- Open the VEGA Tools app and enter the serial number under "**Documentation**".

## 3 Mounting

### Protection against moisture

#### 3.1 General instructions for use of the instrument

Protect your instrument against moisture ingress through the following measures:

- Use a suitable connection cable (see chapter "Connecting to power supply")
- Tighten the cable gland or plug connector
- Lead the connection cable downward in front of the cable entry or plug connector

This applies mainly to outdoor installations, in areas where high humidity is expected (e.g. through cleaning processes) and on cooled or heated vessels.



#### Note:

Make sure that during installation or maintenance no moisture or dirt can get inside the instrument.

To maintain the housing protection, make sure that the housing lid is closed during operation and locked, if necessary.

### Filter element - Position

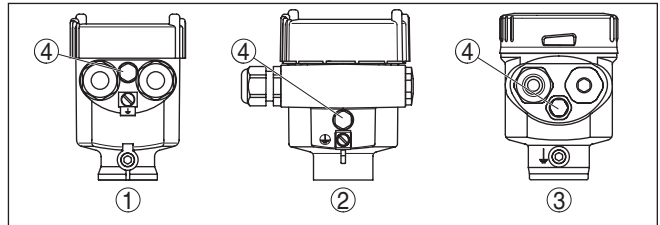

Fig. 1: Position of the filter element - non-Ex, Ex ia version

- 1 Plastic, stainless steel housing (precision casting)
- 2 Aluminium housing
- 3 Stainless steel housing (electropolished)
- 4 Filter element

With the following instruments a blind plug is installed instead of the filter element:

- Instruments in protection IP66/IP68 (1 bar) - ventilation via capillaries in non-detachable cable
- Instruments with absolute pressure

#### 3.3 Combination Primary/Secondary sensor

In principle, any sensor combination within the instrument series is allowed. The following requirements must be fulfilled:

- Configuration of the sensor suitable for electronic differential pressure
- Pressure type is identical for both sensors, i.e. relative pressure/relative pressure or absolute pressure/absolute pressure

- Primary Device measures the higher pressure
- Measurement setup as shown in the following chapters

The measuring range of each sensor is selected such that it fits the measuring loop. For this, the max. recommended turn down must be noted. See chapter " *Technical data*". It is absolutely necessary the the measuring ranges of Primary and Secondary Device correspond.

**Measurement result = Measured value of Primary (total pressure) - measured value of Secondary (static pressure)**

Depending on the application, individual combinations can result, see following examples:

#### Example - large vessel

##### Data

Application: Level measurement

Medium: Water

Vessel height: 12 m, hydrostatic pressure =  $12 \text{ m} \times 1000 \text{ kg/m}^3 \times 9.81 \text{ m/s}^2 = 117.7 \text{ kPa} = 1.18 \text{ bar}$

Superimposed pressure: 1 bar

Total pressure:  $1.18 \text{ bar} + 1 \text{ bar} = 2.18 \text{ bar}$

##### Instrument selection

Nominal measuring range Primary: 2.5 bar

Nominal measuring range Secondary: 1 bar

Turn Down:  $2.5 \text{ bar} / 1.18 \text{ bar} = 2.1 : 1$

#### Example - small vessel

##### Data

Application: Level measurement

Medium: Water

Vessel height: 500 mm, hydrostatic pressure =  $0.50 \text{ m} \times 1000 \text{ kg/m}^3 \times 9.81 \text{ m/s}^2 = 4.9 \text{ kPa} = 0.049 \text{ bar}$

Superimposed pressure: 350 mbar = 0.35 bar

Total pressure:  $0.049 \text{ bar} + 0.35 \text{ bar} = 0.399 \text{ bar}$

##### Instrument selection

Nominal measuring range Primary: 0.4 bar

Nominal measuring range Secondary: 0.4 bar

Turn Down:  $0.4 \text{ bar} / 0.049 \text{ bar} = 8.2 : 1$

#### Example - orifice in pipeline

##### Data

Application: Differential pressure measurement

Medium: Gas

Static pressure: 0.8 bar

Differential pressure on orifice: 50 mbar = 0.050 bar

Total pressure:  $0.8 \text{ bar} + 0.05 \text{ bar} = 0.85 \text{ bar}$

##### Instrument selection

Nominal measuring range Primary: 1 bar

Nominal measuring range Secondary: 1 bar

Turn Down:  $1 \text{ bar} / 0.050 \text{ bar} = 20 : 1$

**Output measured values** The measuring result (level, pressure difference) as well as measured value Secondary (static or superimposed pressure) are output by the sensor. Depending on the instrument version, output as 4 ... 20 mA signal or digitally via HART, Profibus PA or Foundation Fieldbus.



## 4 Connecting to power supply

### 4.1 Connecting

#### Connection technology

The connection to the Primary Device is carried out through spring-loaded terminals in the respective housing. For this, use the supplied, confectioned cable. Solid cores as well as flexible cores with cable end sleeves are inserted directly into the terminal openings.

In case of flexible cores without end sleeves, press the terminal from above with a small screwdriver, the terminal opening is then free. When the screwdriver is released, the terminal closes again.



#### Information:

The terminal block is pluggable and can be removed from the electronics. To do this, lift the terminal block with a small screwdriver and pull it out. When reinserting the terminal block, you should hear it snap in.

You can find further information on the max. wire cross-section under "*Technical data - Electromechanical data*".

#### Connection procedure

Proceed as follows:

1. Unscrew the housing lid
2. Loosen compression nut of the cable gland and remove blind plug
3. Remove approx. 10 cm (4 in) of the cable mantle, strip approx. 1 cm (0.4 in) insulation from the individual wires or use supplied connection cable
4. Insert the cable into the sensor through the cable entry



Fig. 2: Connection steps 5 and 6

5. Insert the wire ends into the terminals according to the wiring plan
6. Check the hold of the wires in the terminals by lightly pulling on them

7. Connect the shielding to the internal ground terminal, connect the external ground terminal to potential equalisation
  8. Tighten the compression nut of the cable entry gland. The seal ring must completely encircle the cable
  9. Unscrew the blind plug on the Primary, screw in the supplied cable gland
  10. Connection cable to Primary, see steps 3 to 8
  11. Screw the housing lid back on
- The electrical connection is finished.

## 4.2 Single chamber housing



The following illustration applies to the non-Ex, Ex ia and Ex d ia version.

### Electronics and connection compartment

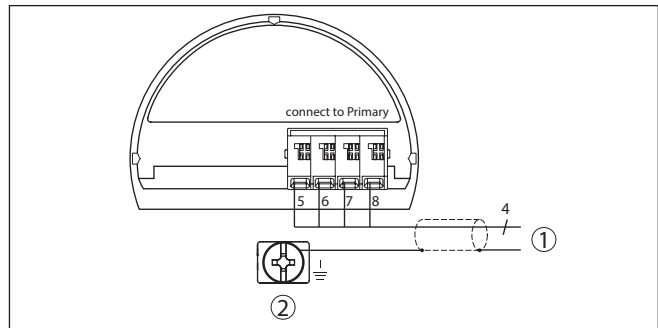

Fig. 3: Wiring plan VEGABAR 81 Secondary Device

- 1 To the Primary Device
- 2 Ground terminal for connection of the cable screening<sup>2)</sup>

## 4.3 Connection example

### Connection example, electronic differential pressure

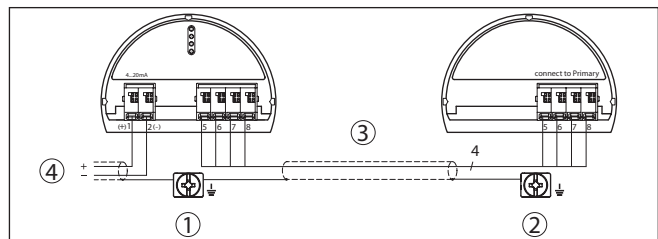

Fig. 4: Connection example, electronic differential pressure

- 1 Primary Device
- 2 Secondary Device
- 3 Connection cable
- 4 Supply and signal circuit Primary Device

<sup>2)</sup> Connect shielding here. Connect ground terminal on the outside of the housing to ground as prescribed. The two terminals are galvanically connected.

The connection between Primary and Secondary Device is carried out acc. to the table:

<b>Primary Device</b>	<b>Secondary Device</b>
Terminal 5	Terminal 5
Terminal 6	Terminal 6
Terminal 7	Terminal 7
Terminal 8	Terminal 8

## 5 Set up with the display and adjustment module

### 5.1 Parameter adjustment - Quick setup

To quickly and easily adapt the sensor to the application, select the menu item "Quick setup" in the start graphic on the display and adjustment module.

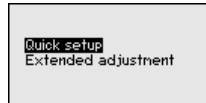

Carry out the following steps in the sequence specified below. The presettings apply to all applications.

You can find "Extended adjustment" in the next sub-chapter.

#### Presettings

#### Measurement loop name

In the first menu item you assign a suitable measurement loop name. Permitted are names with max. 19 characters.

#### Application

In this menu item you activate/deactivate the Secondary sensor for electronic differential pressure and select the application.



#### Note:

It is absolutely necessary to activate the Secondary sensor in advance to have the applications displayed in the electronic differential pressure measurement menus.

#### Units

In this menu item you determine the adjustment and temperature units of the instrument. Depending on the selected application in the menu item "Application", different adjustment units are available.

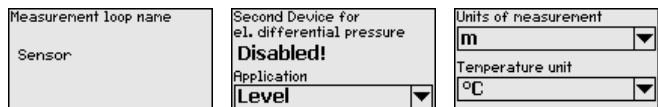

#### Quick setup - Level measurement

#### Unit, static pressure

In this menu item, you determine the unit of the static, i.e. superimposed pressure.

#### Position correction

In this menu item you compensate the influence of the installation position of the instrument (offset) on the measured value.

#### Min. adjustment

In this menu item you carry out the min. adjustment for level.

Enter the percentage value and the corresponding pressure value for the min. level.

#### Max. adjustment

In this menu item you carry out the max. adjustment for level.

Enter the percentage value and the corresponding pressure value for the max. level.

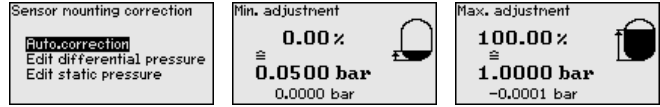

The quick setup for level measurement is finished.

**Quick setup - Flow measurement**

**Position correction**

In this menu item you compensate the influence of the installation position of the instrument (offset) on the measured value.

**Min. adjustment**

In this menu item you carry out the min. adjustment for flow.

Enter the percentage value and the corresponding pressure value for the min. flow.

**Max. adjustment**

In this menu item you carry out the max. adjustment for flow.

Enter the percentage value and the corresponding pressure value for the max. flow.

**Linearisation**

In this menu item, you select the characteristics of the output signal.

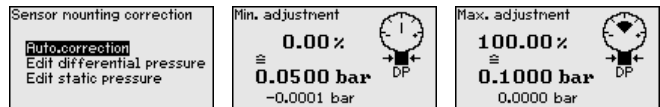

The quick setup for flow measurement is finished.

**Quick setup - Differential pressure measurement**

**Unit, static pressure**

In this menu item, you determine the unit of the static, i.e. superimposed pressure.

**Position correction**

In this menu item you compensate the influence of the installation position of the instrument (offset) on the measured value.

**Zero adjustment**

In this menu item you carry out the Zero adjustment for the differential pressure.

Enter the corresponding pressure value for 0 %.

**Span adjustment**

In this menu item you carry out the Span adjustment for the differential pressure

Enter the corresponding pressure value for 100 %.

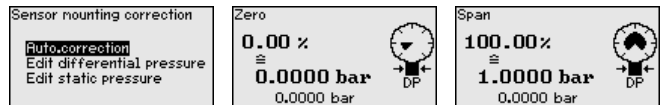

### Quick setup - Density measurement

The quick setup for differential pressure measurement is finished.

#### Unit, static pressure

In this menu item, you determine the unit of the static, i.e. superimposed pressure.

#### Position correction

In this menu item you compensate the influence of the installation position of the instrument (offset) on the measured value.

#### Distance

In this menu item, you enter the installation distance between Primary and Secondary sensor.

#### Min. adjustment

In this menu item you carry out the min. adjustment for density.

Enter the percentage value and the corresponding density value for the min. density.

#### Max. adjustment

In this menu item you carry out the max. adjustment for density.

Enter the percentage value and the corresponding density value for the max. density.

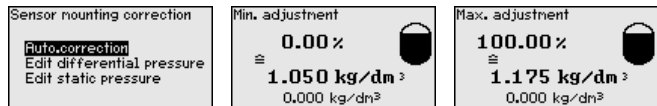

The quick setup for density measurement is finished.

### Quick setup - Interface measurement

#### Unit, static pressure

In this menu item, you determine the unit of the static, i.e. superimposed pressure.

#### Position correction

In this menu item you compensate the influence of the installation position of the instrument (offset) on the measured value.

#### Distance

In this menu item, you enter the installation distance between Primary and Secondary sensor.

#### Min. adjustment

In this menu item, you carry out the adjustment for the min. height of the interface.

Enter the percentage value and the corresponding height of the interface.

#### Max. adjustment

In this menu item, you carry out the adjustment for the max. height of the interface.

Enter the percentage value and the corresponding height of the interface.

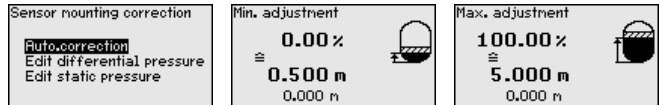

The quick setup for interface measurement is finished.

**Quick setup - density-compensated level measurement**

**Unit, static pressure**

In this menu item, you determine the unit of the static, i.e. superimposed pressure.

**Position correction**

In this menu item you compensate the influence of the installation position of the instrument (offset) on the measured value.

**Distance**

In this menu item, you enter the installation distance between Primary and Secondary sensor.

**Min. adjustment**

In this menu item you carry out the min. adjustment for level.

Enter the percentage value and the corresponding pressure value for the min. level.

**Max. adjustment**

In this menu item you carry out the max. adjustment for level.

Enter the percentage value and the corresponding pressure value for the max. level.



The quick setup for density-compensated level measurement is hence finished.

**Parameterization example**

VEGABAR 81 always measures pressure independently of the process variable selected in the menu item "Application". To output the selected process variable correctly, an allocation of the output signal to 0 % and 100 % must be carried out (adjustment).

With the application "Level", the hydrostatic pressure, e.g. with full and empty vessel, is entered for adjustment. A superimposed pressure is detected by the Secondary sensor and automatically compensated. See the following example:

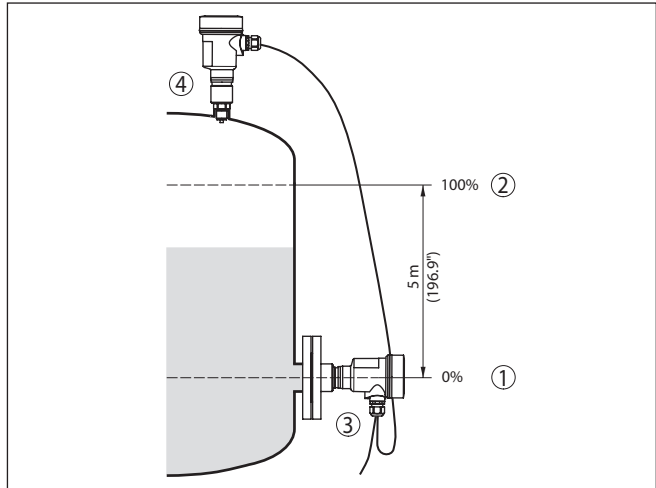

Fig. 5: Parameter adjustment example Min./max. adjustment, level measurement

- 1 Min. level = 0 % corresponds to 0.0 mbar
- 2 Max. level = 100 % corresponds to 490.5 mbar
- 3 VEGABAR 81
- 4 VEGABAR 81, Secondary sensor

If these values are not known, an adjustment with filling levels of e.g. 10 % and 90 % is also possible. By means of these settings, the real filling height is then calculated.

The actual product level during this adjustment is not important, because the min./max. adjustment is always carried out without changing the product level. These settings can be made ahead of time without the instrument having to be installed.

## 5.2 Parameter adjustment - Extended adjustment

For technically demanding measuring points, you can carry out extended settings in "Extended adjustment".

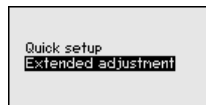

### Main menu

The main menu is divided into five sections with the following functions:

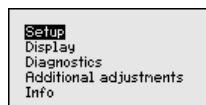

**Setup:** Settings, e.g., for measurement loop name, application, units, position correction, adjustment, signal output

**Display:** Settings, e.g., for language, measured value display, lighting



**Diagnosis:** Information, e.g. on instrument status, peak indicator, measurement reliability, simulation

**Additional adjustments:** PIN, date/time, reset, copy function

**Info:** Instrument name, hardware and software version, date of manufacture, sensor features

In the main menu item "Setup", the individual submenu items should be selected one after the other and provided with the correct parameter values.

The following submenu points are available:



In the following section, the menu items from the menu "Setup" for electronic differential pressure measurement are described in detail. Depending on the selected application, different sections are relevant.



**Information:**

Further menu items of the menu "Setup" as well as the complete menus "Display", "Diagnosis", "Additional adjustments" and "Info" are described in the operating instructions of the respective Primary Device.

**5.3 Menu overview**

The following tables show the adjustment menu of the instrument. Depending on the instrument version or application, all menu items may not be available or some may be differently assigned.



**Note:**

You can find further menu items in the operating instructions of the respective Primary Device.

**Setup**

Menu item	Parameter	Default setting
Measurement loop name	19 alphanumeric characters/special characters	Sensor
Application	Application	Level
	Secondary Device for electronic differential pressure	Deactivated
Units	Unit of measurement	mbar (with nominal measuring range ≤ 400 mbar) bar (with nominal measuring ranges ≥ 1 bar)
	Static pressure	bar
Position correction		0.00 bar

Menu item	Parameter	Default setting
Adjustment	Distance (with density and interface)	1.00 m
	Zero/Min. adjustment	0.00 bar 0.00 %
	Span/Max. adjustment	Nominal measuring range in bar 100.00 %
Damping	Integration time	0.0 s
Linearisation	Linear, cylindrical tank, ... user-defined	Linear
Current output	Current output - Mode	Output characteristics 4 ... 20 mA Reaction when malfunctions occur ≤ 3.6 mA
	Current output - Min./Max.	3.8 mA 20.5 mA
Lock adjustment	Blocked, released	Last setting

## Display

Menu item	Default setting
Menu language	Order-specific
Displayed value 1	Current output in %
Displayed value 2	Ceramic measuring cell: Measuring cell temperature in °C Metallic measuring cell: Electronics temperature in °C
Display format	Number of positions after the decimal point, automatically
Backlight	Switched on

## Diagnostics

Menu item	Parameter	Default setting
Device status		-
Peak indicator	Pressure	Current pressure measured value
Peak indicator temp.	Temperature	Actual measuring cell and electronic temperature
Simulation	Pressure, percent, signal output, linearized percent, measuring cell temperature, electronics temperature	-

### Additional adjustments

Menu item	Parameter	Default setting
Date/Time		Actual date/Actual time
Reset	Delivery status, basic settings	
Copy instrument settings	Read from sensor, write into sensor	
Scaling	Scaling size	Volume in l
	Scaling format	0 % corresponds to 0 l 100 % corresponds to 0 l
Current output	Current output - Meas. variable	Lin. percent - Level
	Current output - Adjustment	0 ... 100 % correspond to 4 ... 20 mA
HART mode		Address 0
DP flow element	Unit	m <sup>3</sup> /s
	Adjustment	0.00 % correspond to 0.00 m <sup>3</sup> /s 100.00 %, 1 m <sup>3</sup> /s
Special parameters	Service-Login	No reset

### Info

Menu item	Parameter
Device name	VEGABAR 81
Instrument version	Hardware and software version
Factory calibration date	Date
Sensor characteristics	Order-specific characteristics

## 6 Supplement

### 6.1 Technical data

#### Note for approved instruments

The technical data in the respective safety instructions which are included in delivery are valid for approved instruments (e.g. with Ex approval). These data can differ from the data listed herein, for example regarding the process conditions or the voltage supply.

All approval documents can be downloaded from our homepage.

#### Electromechanical data - version IP66/IP67 and IP66/IP68 (0.2 bar)<sup>3)</sup>

Options of the cable entry

- Cable entry M20 x 1.5; ½ NPT
- Cable gland M20 x 1.5; ½ NPT (cable diameter see below table)
- Blind plug M20 x 1.5; ½ NPT
- Closing cap ½ NPT

Material cable gland/Seal insert	Cable diameter		
	5 ... 9 mm	6 ... 12 mm	7 ... 12 mm
PA/NBR	√	√	–
Brass, nickel-plated/NBR	√	√	–
Stainless steel/NBR	–	–	√

Wire cross-section (spring-loaded terminals)

- Massive wire, stranded wire 0.2 ... 2.5 mm<sup>2</sup> (AWG 24 ... 14)
- Stranded wire with end sleeve 0.2 ... 1.5 mm<sup>2</sup> (AWG 24 ... 16)

#### Interface to the Primary Device

Data transmission Digital (I<sup>2</sup>C-Bus)

Connection cable Secondary - Primary, mechanical data

- Configuration Cores, strain relief, braided, metal foil, jacket
- Standard length 5 m (16.40 ft)
- Max. length 70 m (229.7 ft)
- Min. bending radius (at 25 °C/77 °F) 25 mm (0.985 in)
- Diameter approx. 8 mm (0.315 in), approx. 6 mm (0.236 in)
- Material PE, PUR
- Colour Black, blue

Connection cable Secondary - Primary, electrical data

- Wire cross-section 0.34 mm<sup>2</sup> (AWG 22)
- Wire resistance < 0.05 Ω/m (0.015 Ω/ft)

<sup>3)</sup> IP66/IP68 (0.2 bar), only with absolute pressure.

---

**Voltage supply for the complete system through Primary Device**

---

Operating voltage

- $U_{B \min}$  12 V DC
- $U_{B \min}$  with lighting switched on 16 V DC
- $U_{B \max}$  Depending on the signal output and version of the Primary Devices



A large grid area for taking notes, consisting of 20 columns and 30 rows of small squares.

Printing date:

**VEGA**

All statements concerning scope of delivery, application, practical use and operating conditions of the sensors and processing systems correspond to the information available at the time of printing.

Subject to change without prior notice

© VEGA Grieshaber KG, Schiltach/Germany 2023



46331-EN-230914

VEGA Grieshaber KG  
Am Hohenstein 113  
77761 Schiltach  
Germany

Phone +49 7836 50-0  
E-mail: [info.de@vega.com](mailto:info.de@vega.com)  
[www.vega.com](http://www.vega.com)