

Quick setup guide

Submersible pressure transmitter with ceramic measuring cell

VEGABAR 86

Modbus and Levelmaster protocol



Document ID: 46324



VEGA

Contents

1 For your safety	3
1.1 Authorised personnel	3
1.2 Appropriate use.....	3
1.3 Warning about incorrect use.....	3
1.4 General safety instructions	3
1.5 Conformity.....	3
1.6 NAMUR recommendations	4
1.7 Environmental instructions	4
2 Product description	5
2.1 Configuration.....	5
3 Mounting.....	6
3.1 General instructions for use of the instrument	6
3.2 Ventilation and pressure compensation.....	6
4 Connecting to power supply and bus system	7
4.1 Connecting.....	7
4.2 Wiring plan	8
5 Set up the sensor with the display and adjustment module.....	10
5.1 Insert display and adjustment module	10
5.2 Parameter adjustment - Quick setup	10
5.3 Parameter adjustment - Extended adjustment.....	12
5.4 Menu overview	13
6 Set up with smartphone/tablet, PC/notebook via Bluetooth.....	16
6.1 Preparations.....	16
6.2 Connecting.....	17
6.3 Sensor parameter adjustment	17
7 Supplement	19
7.1 Technical data	19



Information:

This quick setup guide enables quick setup and commissioning of your instrument.

You can find supplementary information in the corresponding, more detailed Operating Instructions Manual as well as the Safety Manual that comes with instruments with SIL qualification. These manuals are available on our homepage.

Operating instructions VEGABAR 86 - Modbus and Levelmaster protocol: Document-ID 46296

Editing status of the quick setup guide: 2023-09-06

1 For your safety

1.1 Authorised personnel

All operations described in this documentation must be carried out only by trained and authorized personnel.

During work on and with the device, the required personal protective equipment must always be worn.

1.2 Appropriate use

Model VEGABAR 86 is a pressure transmitter for level and gauge measurement.

You can find detailed information about the area of application in chapter " *Product description*".

Operational reliability is ensured only if the instrument is properly used according to the specifications in the operating instructions manual as well as possible supplementary instructions.

1.3 Warning about incorrect use

Inappropriate or incorrect use of this product can give rise to application-specific hazards, e.g. vessel overfill through incorrect mounting or adjustment. Damage to property and persons or environmental contamination can result. Also, the protective characteristics of the instrument can be impaired.

1.4 General safety instructions

This is a state-of-the-art instrument complying with all prevailing regulations and directives. The instrument must only be operated in a technically flawless and reliable condition. The operating company is responsible for the trouble-free operation of the instrument. When measuring aggressive or corrosive media that can cause a dangerous situation if the instrument malfunctions, the operating company has to implement suitable measures to make sure the instrument is functioning properly.

The safety instructions in this operating instructions manual, the national installation standards as well as the valid safety regulations and accident prevention rules must be observed.

For safety and warranty reasons, any invasive work on the device beyond that described in the operating instructions manual may be carried out only by personnel authorised by us. Arbitrary conversions or modifications are explicitly forbidden. For safety reasons, only the accessory specified by us must be used.

To avoid any danger, the safety approval markings and safety tips on the device must also be observed.

1.5 Conformity

The device complies with the legal requirements of the applicable country-specific directives or technical regulations. We confirm conformity with the corresponding labelling.

The corresponding conformity declarations can be found on our homepage.

1.6 NAMUR recommendations

NAMUR is the automation technology user association in the process industry in Germany. The published NAMUR recommendations are accepted as the standard in field instrumentation.

The device fulfils the requirements of the following NAMUR recommendations:

- NE 21 – Electromagnetic compatibility of equipment
- NE 53 – Compatibility of field devices and display/adjustment components
- NE 107 – Self-monitoring and diagnosis of field devices

For further information see www.namur.de.

1.7 Environmental instructions

Protection of the environment is one of our most important duties. That is why we have introduced an environment management system with the goal of continuously improving company environmental protection. The environment management system is certified according to DIN EN ISO 14001.

Please help us fulfil this obligation by observing the environmental instructions in this manual:

- Chapter "*Packaging, transport and storage*"
- Chapter "*Disposal*"

2 Product description

2.1 Configuration

Type label

The type label contains the most important data for identification and use of the instrument:

- Instrument type
- Information about approvals
- Configuration information
- Technical data
- Serial number of the instrument
- QR code for device identification
- Numerical code for Bluetooth access (optional)
- Manufacturer information

Documents and software

To find order data, documents or software related to your device, you have the following options:

- Move to "www.vega.com" and enter in the search field the serial number of your instrument.
- Scan the QR code on the type label.
- Open the VEGA Tools app and enter the serial number under "**Documentation**".

3 Mounting

3.1 General instructions for use of the instrument

Protection against moisture

Protect your instrument against moisture ingress through the following measures:

- Use a suitable connection cable (see chapter "Connecting to power supply")
- Tighten the cable gland or plug connector
- Lead the connection cable downward in front of the cable entry or plug connector

This applies mainly to outdoor installations, in areas where high humidity is expected (e.g. through cleaning processes) and on cooled or heated vessels.



Note:

Make sure that during installation or maintenance no moisture or dirt can get inside the instrument.

To maintain the housing protection, make sure that the housing lid is closed during operation and locked, if necessary.

3.2 Ventilation and pressure compensation

Filter element - Position

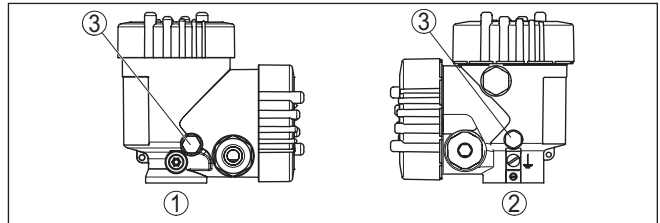

Fig. 1: Position of the filter element

- 1 Plastic double chamber housing
- 2 Aluminium, stainless steel (precision casting) double chamber
- 3 Filter element

4 Connecting to power supply and bus system

4.1 Connecting

Connection technology

The voltage supply and signal output are connected via the spring-loaded terminals in the housing.

Connection to the display and adjustment module or to the interface adapter is carried out via contact pins in the housing.



Information:

The terminal block is pluggable and can be removed from the electronics. To do this, lift the terminal block with a small screwdriver and pull it out. When reinserting the terminal block, you should hear it snap in.

Connection procedure

Proceed as follows:

1. Unscrew the housing lid
2. Loosen compression nut of the cable gland and remove blind plug
3. Remove approx. 10 cm (4 in) of the cable mantle (signal output), strip approx. 1 cm (0.4 in) insulation from the ends of the individual wires
4. Insert the cable into the sensor through the cable entry



Fig. 2: Connection steps 5 and 6

5. Insert the wire ends into the terminals according to the wiring plan



Information:

Solid cores as well as flexible cores with wire end sleeves are inserted directly into the terminal openings. In case of flexible cores without end sleeves, press the terminal from above with a small screwdriver, the terminal opening is then free. When the screwdriver is released, the terminal closes again.

6. Check the hold of the wires in the terminals by lightly pulling on them
7. Connect the cable screening to the internal ground terminal, connect the outer ground terminal to potential equalisation in case of power supply via low voltage
8. Connect the lead cable for voltage supply in the same way according to the wiring plan, in addition connect the ground conductor to the inner ground terminal when powered with mains voltage.
9. Tighten the compression nut of the cable entry gland. The seal ring must completely encircle the cable
10. Screw the housing lid back on

The electrical connection is finished.



Information:

The terminal blocks are pluggable and can be removed from the housing insert. To do this, lift the terminal block with a small screwdriver and pull it out. When inserting the terminal block again, you should hear it snap in.

4.2 Wiring plan

Overview

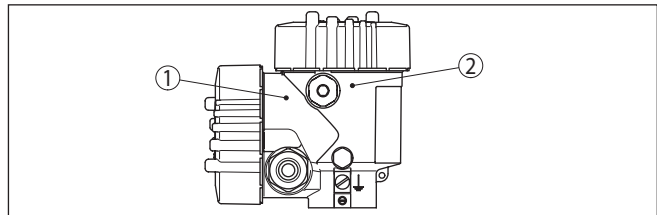

Fig. 3: Position of connection compartment (Modbus electronics) and electronics compartment (sensor electronics)

- 1 Connection compartment
- 2 Electronics compartment

Connection compartment

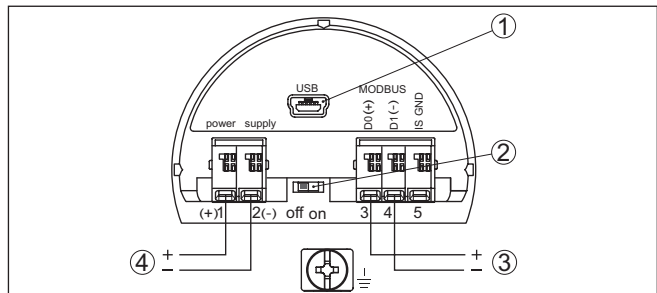

Fig. 4: Connection compartment

- 1 USB interface
- 2 Slide switch for integrated termination resistor (120 Ω)
- 3 Modbus signal
- 4 Voltage supply

Terminal	Function	Polarity
1	Voltage supply	+
2	Voltage supply	-
3	Modbus signal D0	+
4	Modbus signal D1	-
5	Function ground when installing according to CSA (Canadian Standards Association)	

5 Set up the sensor with the display and adjustment module

5.1 Insert display and adjustment module

The display and adjustment module can be inserted into the sensor and removed again at any time. You can choose any one of four different positions - each displaced by 90°. It is not necessary to interrupt the power supply.

Proceed as follows:

1. Unscrew the housing lid
2. Place the display and adjustment module on the electronics in the desired position and turn it to the right until it snaps in.
3. Screw housing lid with inspection window tightly back on

Disassembly is carried out in reverse order.

The display and adjustment module is powered by the sensor, an additional connection is not necessary.



Fig. 5: Insertion of the display and adjustment module



Note:

If you intend to retrofit the instrument with a display and adjustment module for continuous measured value indication, a higher lid with an inspection glass is required.

5.2 Parameter adjustment - Quick setup

To quickly and easily adapt the sensor to the application, select the menu item "Quick setup" in the start graphic on the display and adjustment module.



Carry out the following steps in the below sequence.

You can find " *Extended adjustment*" in the next sub-chapter.

Presettings

Measurement loop name

In the first menu item you assign a suitable measurement loop name. Permitted are names with max. 19 characters.

Application

In this menu item, you select the application. The selection comprises process pressure and level measurement.



Information:

With VEGABAR 86 Modbus, the connection of a slave sensor is not possible. The item "Secondary sensor" must therefore be set to " *Deactivate*".

Units

In this menu item you determine the adjustment and temperature units of the instrument. Depending on the selected application in the menu item " *Application*", different adjustment units are available.

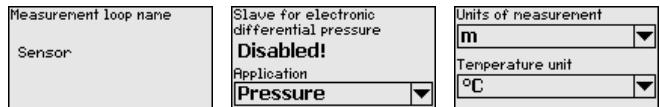

Quick setup - Process pressure measurement

Position correction

In this menu item you compensate the influence of the installation position of the instrument (offset) on the measured value.

Zero adjustment

In this menu item you carry out the zero adjustment for the process pressure.

Enter the corresponding pressure value for 0 %.

Span adjustment

In this menu item you carry out the span adjustment for the process pressure

Enter the corresponding pressure value for 100 %.

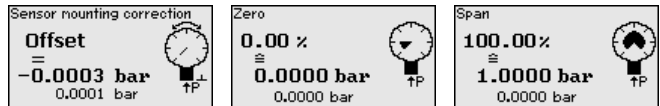

Quick setup - Level measurement

Position correction

In this menu item you compensate the influence of the installation position of the instrument (offset) on the measured value.

Max. adjustment

In this menu item you carry out the max. adjustment for level

Enter the percentage value and the corresponding value for the max. level.

Min. adjustment

In this menu item you carry out the min. adjustment for level

Enter the percentage value and the corresponding value for the min. level.



The quick setup is finished.

Parameterization example VEGABAR 86 always measures pressure independently of the process variable selected in the menu item "Application". To output the selected process variable correctly, an allocation of the output signal to 0 % and 100 % must be carried out (adjustment).

During adjustment, the pressure is entered e.g. for the level with full and empty vessel, see following example:

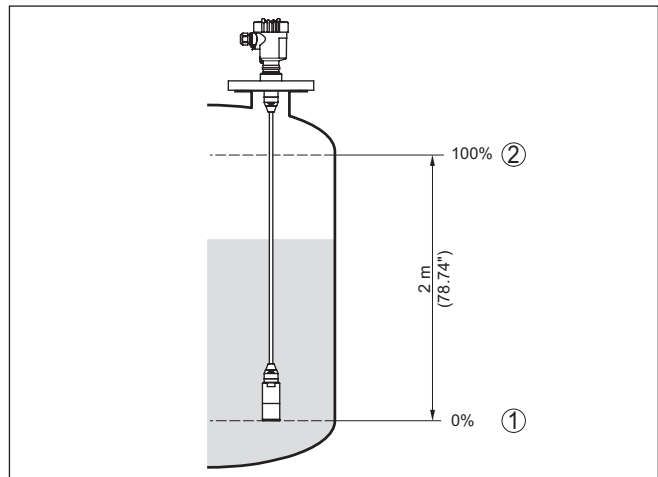

Fig. 6: Parameter adjustment example Min./max. adjustment, level measurement

- 1 Min. level = 0 % corresponds to 0.0 mbar
- 2 Max. level = 100 % corresponds to 196.2 mbar

If these values are not known, an adjustment with filling levels of e.g. 10 % and 90 % is also possible. By means of these settings, the real filling height is then calculated.

The actual product level during this adjustment is not important, because the min./max. adjustment is always carried out without changing the product level. These settings can be made ahead of time without the instrument having to be installed.

5.3 Parameter adjustment - Extended adjustment

For technically demanding measuring points, you can carry out extended settings in "Extended adjustment".

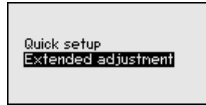

Main menu

The main menu is divided into five sections with the following functions:

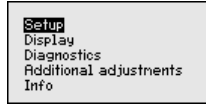

Setup: Settings e. g. for measurement loop name, application, units, position correction, adjustment, signal output, disable/enable operation

Display: Settings, e.g., for language, measured value display, lighting

Diagnosis: Information, for example, of device status, peak indicator, simulation

Additional adjustments: date/time, reset, copy function

Info: Instrument name, hardware and software version, calibration date, sensor features



Note:

For optimum setting of the measuring point, the individual submenu items in the main menu item " *Setup* " should be selected one after the other and provided with the correct parameters. If possible, go through the items in the given sequence.

The submenu points are described below.

5.4 Menu overview

The following tables show the adjustment menu of the instrument. Depending on the instrument version or application, all menu items may not be available or some may be differently assigned.

Setup

Menu item	Parameter	Default value
Measurement loop name		Sensor
Application	Application	Level
	Secondary sensor for electronic differential pressure	Deactivated
Units	Unit of measurement	mbar (with nominal measuring range ≤ 400 mbar) bar (with nominal measuring ranges ≥ 1 bar)
	Temperature unit	°C
Position correction		0.00 bar

Menu item	Parameter	Default value
Adjustment	Zero/Min. adjustment	0.00 bar 0.00 %
	Span/Max. adjustment	Nominal measuring range in bar 100.00 %
Damping	Integration time	1 s
Lock adjustment	Blocked, released	Released

Display

Menu item	Default value
Menu language	Selected language
Displayed value 1	Current output in %
Displayed value 2	Ceramic measuring cell: Measuring cell temperature in °C Metallic measuring cell: Electronics temperature in °C
Display format	Number of positions after the decimal point, automatically
Backlight	Switched on

Diagnostics

Menu item	Parameter	Default value
Device status		-
Peak indicator	Pressure	Current pressure measured value
Peak indicator temp.	Temperature	Actual measuring cell and electronic temperature
Simulation		Process pressure

Additional adjustments

Menu item	Parameter	Default value
Date/Time		Actual date/Actual time
Reset	Delivery status, basic settings	
Copy instrument settings	Read from sensor, write into sensor	
Scaling	Scaling size	Volume in l
	Scaling format	0 % corresponds to 0 l 100 % corresponds to 100 l
Special parameters	Service-Login	No reset

Info

Menu item	Parameter
Device name	VEGABAR 86
Instrument version	Hardware and software version

Menu item	Parameter
Factory calibration date	Date
Sensor characteristics	Order-specific characteristics

6 Set up with smartphone/tablet, PC/ notebook via Bluetooth

6.1 Preparations

Activate Bluetooth

Make sure that the Bluetooth function of the display and adjustment module is activated. For this, the switch on the bottom side must be set to "On".

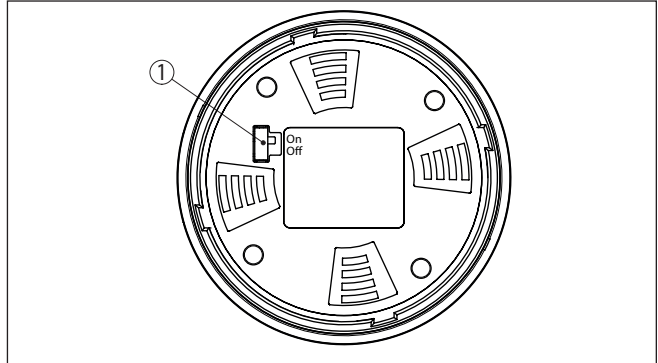

Fig. 7: Activate Bluetooth

1 Switch

On = Bluetooth active

Off = Bluetooth not active

Change sensor PIN

The security concept of Bluetooth operation absolutely requires that the default setting of the sensor PIN be changed. This prevents unauthorized access to the sensor.

The default setting of the sensor PIN is "0000". First of all you have to change the sensor PIN in the adjustment menu of the sensor, e.g. to "1111":

- Go to setup via the extended operation

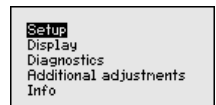
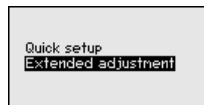

- Lock operation by changing sensor PIN

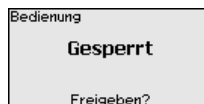
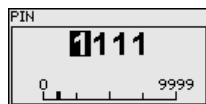
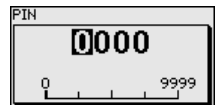
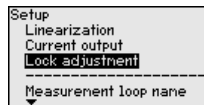
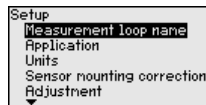

- Enable operation again by entering the sensor PIN once more

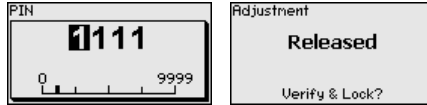

Sensor adjustment via the display/adjustment module or PACTware/DTM by means of VEGACONNECT is thus released again. For access (authentication) with Bluetooth, the changed PIN is still effective.



Note:

Bluetooth access can only be established if the current sensor PIN differs from the default setting "0000". It is possible both when the adjustment is unlocked and when it is locked.

6.2 Connecting

Preparations

Smartphone/Tablet

Start the adjustment app and select the function "Setup". The smartphone/tablet searches automatically for Bluetooth-capable instruments in the area.

PC/Notebook

Start PACTware and the VEGA project assistant. Select the device search via Bluetooth and start the search function. The device automatically searches for Bluetooth-capable devices in the vicinity.

Connecting

The message "*Instrument search running*" is displayed. All devices found are listed in the operating window. The search is automatically continued continuously.

Select in the device list the requested device. The message "*Connecting*" is displayed.

Authenticate

For the first connection, the operating device and the sensor must authenticate each other. After successful authentication, the next connection functions without authentication.

For authentication, enter in the next menu window the 4-digit sensor PIN.

6.3 Sensor parameter adjustment

The sensor parameterization is carried out via the adjustment app on the smartphone/tablet or the DTM on the PC/notebook.

App view

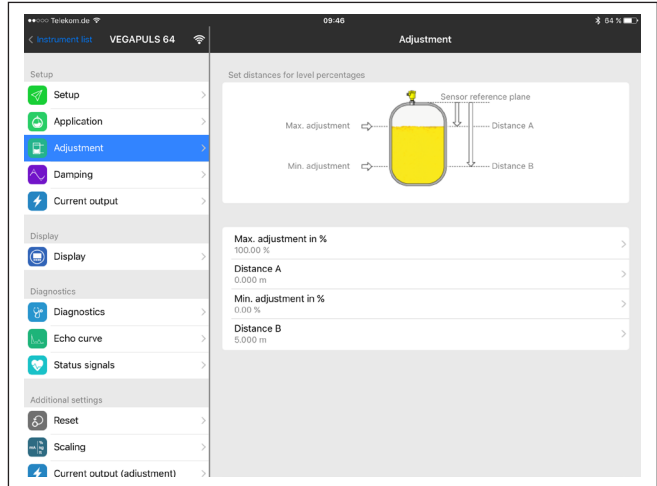

Fig. 8: Example of an app view - Setup sensor adjustment

7 Supplement

7.1 Technical data

Note for approved instruments

The technical data in the respective safety instructions which are included in delivery are valid for approved instruments (e.g. with Ex approval). These data can differ from the data listed herein, for example regarding the process conditions or the voltage supply.

All approval documents can be downloaded from our homepage.

Electromechanical data - version IP66/IP67 and IP66/IP68 (0.2 bar) ¹⁾

Options of the cable entry

- Cable entry M20 x 1.5; ½ NPT
- Cable gland M20 x 1.5; ½ NPT (cable ø see below table)
- Blind plug M20 x 1.5; ½ NPT
- Closing cap ½ NPT

Material cable gland/Seal insert	Cable diameter			
	5 ... 9 mm	6 ... 12 mm	7 ... 12 mm	10 ... 14 mm
PA/NBR	√	√	-	√
Brass, nickel-plated/NBR	√	√	-	-
Stainless steel/NBR	-	-	√	-

Wire cross-section (spring-loaded terminals)

- Massive wire, stranded wire 0.2 ... 2.5 mm² (AWG 24 ... 14)
- Stranded wire with end sleeve 0.2 ... 1.5 mm² (AWG 24 ... 16)

Voltage supply

Operating voltage	8 ... 30 V DC
Max. power consumption	520 mW
Reverse voltage protection	Integrated

¹⁾ IP66/IP68 (0.2 bar), only with absolute pressure.

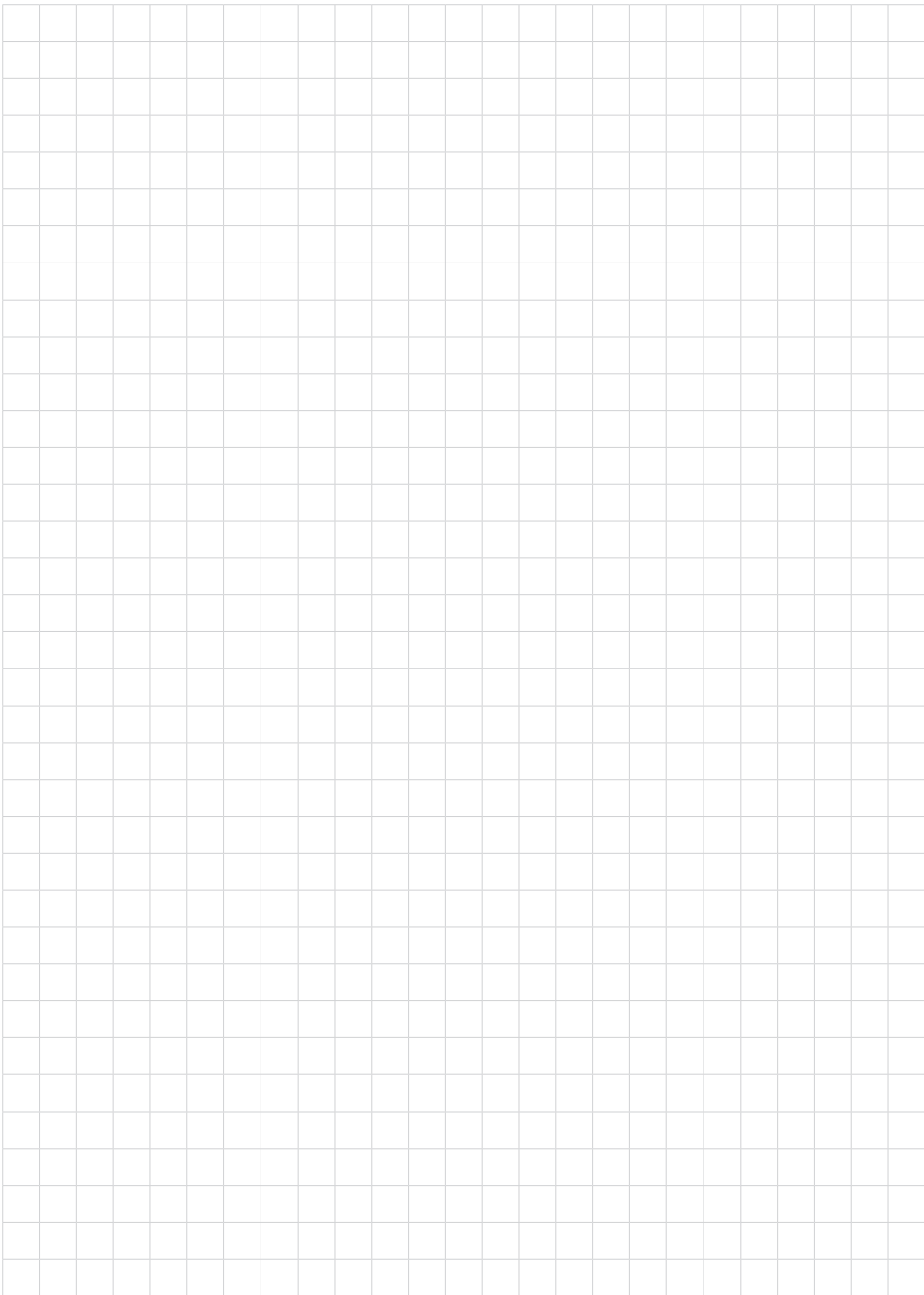



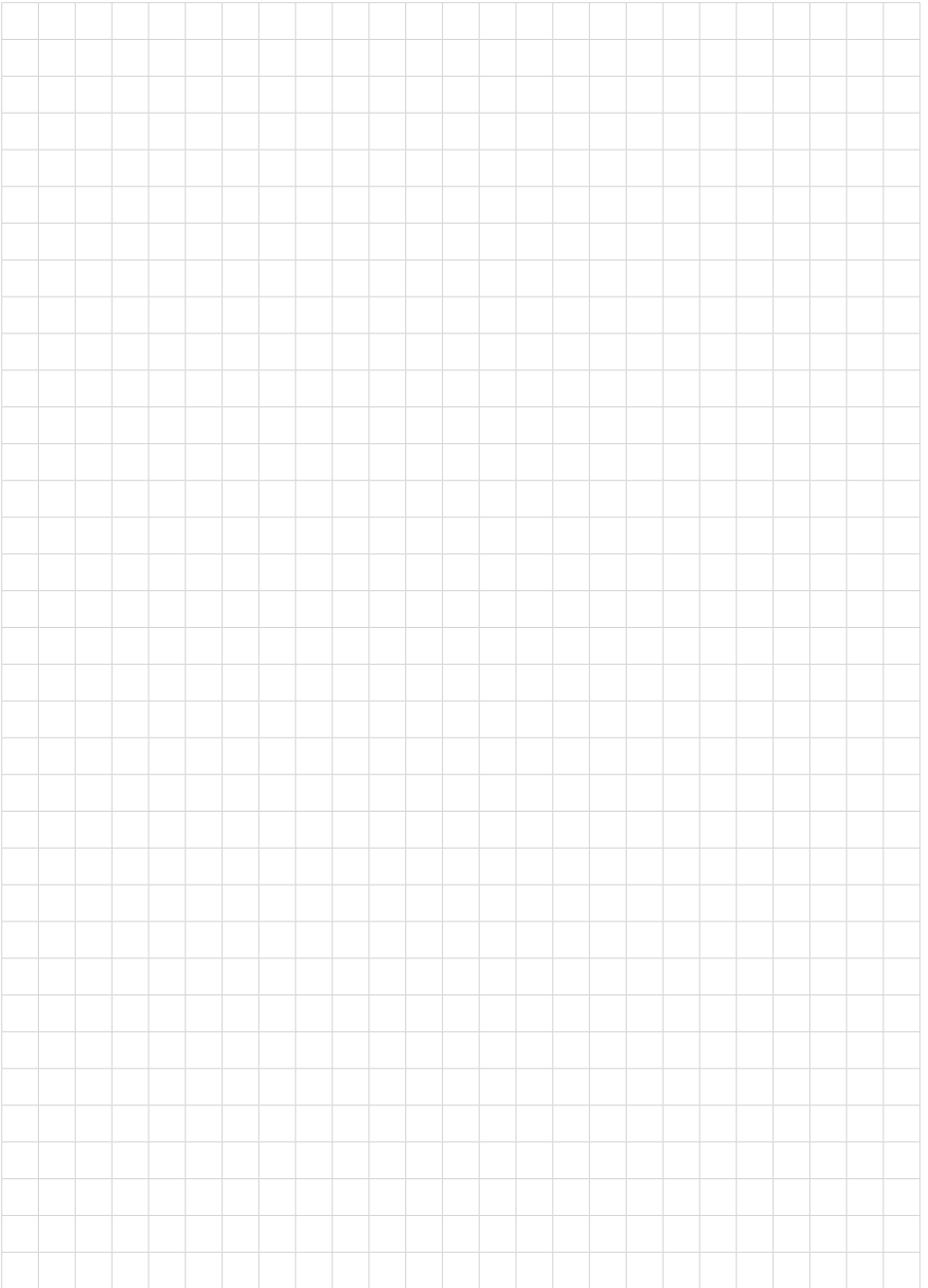

46324-EN-230914

Printing date:

VEGA

All statements concerning scope of delivery, application, practical use and operating conditions of the sensors and processing systems correspond to the information available at the time of printing.

Subject to change without prior notice

© VEGA Grieshaber KG, Schiltach/Germany 2023



46324-EN-230914

VEGA Grieshaber KG
Am Hohenstein 113
77761 Schiltach
Germany

Phone +49 7836 50-0
E-mail: info.de@vega.com
www.vega.com