

Quick setup guide

Pressure transmitter with metallic measuring cell

VEGABAR 83

4 ... 20 mA/HART

With SIL qualification



Document ID: 46315



VEGA

Contents

- 1 For your safety 3**
 - 1.1 Authorised personnel 3
 - 1.2 Appropriate use..... 3
 - 1.3 Warning about incorrect use..... 3
 - 1.4 General safety instructions 3
 - 1.5 Conformity..... 3
 - 1.6 SIL qualification according to IEC 61508..... 4
- 2 Product description 5**
 - 2.1 Configuration..... 5
- 3 Mounting 6**
 - 3.1 General instructions for use of the instrument 6
 - 3.2 Ventilation and pressure compensation..... 6
- 4 Connecting to power supply..... 8**
 - 4.1 Connecting..... 8
 - 4.2 Single chamber housing..... 9
 - 4.3 Double chamber housing 9
- 5 Set up with the display and adjustment module 10**
 - 5.1 Insert display and adjustment module 10
 - 5.2 Parameter adjustment 11
 - 5.3 Menu overview 14
- 6 Set up with smartphone/tablet, PC/notebook via Bluetooth 16**
 - 6.1 Preparations..... 16
 - 6.2 Connecting..... 17
 - 6.3 Sensor parameter adjustment..... 17
- 7 Supplement 19**
 - 7.1 Technical data 19



Information:

This quick setup guide enables quick setup and commissioning of your instrument.

You can find supplementary information in the corresponding, more detailed Operating Instructions Manual as well as the Safety Manual that comes with instruments with SIL qualification. These manuals are available on our homepage.

**Operating instructions VEGABAR 83 - 4 ... 20 mA/HART:
Document-ID 45036**

**Safety Manual VEGABAR series 80 - Two-wire 4 ... 20 mA/HART
with SIL qualification: Document-ID 48369**

Editing status of the quick setup guide: 2023-09-06

1 For your safety

1.1 Authorised personnel

All operations described in this documentation must be carried out only by trained and authorized personnel.

During work on and with the device, the required personal protective equipment must always be worn.

1.2 Appropriate use

The VEGABAR 83 is a pressure transmitter for process pressure and hydrostatic level measurement.

You can find detailed information about the area of application in chapter " *Product description*".

Operational reliability is ensured only if the instrument is properly used according to the specifications in the operating instructions manual as well as possible supplementary instructions.

1.3 Warning about incorrect use

Inappropriate or incorrect use of this product can give rise to application-specific hazards, e.g. vessel overfill through incorrect mounting or adjustment. Damage to property and persons or environmental contamination can result. Also, the protective characteristics of the instrument can be impaired.

1.4 General safety instructions

This is a state-of-the-art instrument complying with all prevailing regulations and directives. The instrument must only be operated in a technically flawless and reliable condition. The operating company is responsible for the trouble-free operation of the instrument. When measuring aggressive or corrosive media that can cause a dangerous situation if the instrument malfunctions, the operating company has to implement suitable measures to make sure the instrument is functioning properly.

The safety instructions in this operating instructions manual, the national installation standards as well as the valid safety regulations and accident prevention rules must be observed.

For safety and warranty reasons, any invasive work on the device beyond that described in the operating instructions manual may be carried out only by personnel authorised by us. Arbitrary conversions or modifications are explicitly forbidden. For safety reasons, only the accessory specified by us must be used.

To avoid any danger, the safety approval markings and safety tips on the device must also be observed.

1.5 Conformity

The device complies with the legal requirements of the applicable country-specific directives or technical regulations. We confirm conformity with the corresponding labelling.

The corresponding conformity declarations can be found on our homepage.

Due to the design of its process fittings, the device does not subject of EU pressure device directive if it is operated at process pressures ≤ 200 bar. ¹⁾

1.6 SIL qualification according to IEC 61508

The Safety Integrity Level (SIL) of an electronic system is used to assess the reliability of integrated safety functions.

For detailed specification of the safety requirements, multiple SIL levels are specified according to safety standard IEC 61508. You can find detailed information in chapter " *Functional safety (SIL)*" of the operating instructions.

The instrument meets the specifications of IEC 61508: 2010 (Edition 2). It is qualified for single-channel operation up to SIL2. The instrument can be used homogeneously redundant up to SIL3 in multi-channel architecture with HFT 1.

¹⁾ Exception: Versions with measuring ranges from 250 bar. These are subject of the EU Pressure Device Directive.

2 Product description

2.1 Configuration

Type label

The type label contains the most important data for identification and use of the instrument:

- Instrument type
- Information about approvals
- Configuration information
- Technical data
- Serial number of the instrument
- QR code for device identification
- Numerical code for Bluetooth access (optional)
- Manufacturer information

Documents and software

To find order data, documents or software related to your device, you have the following options:

- Move to "www.vega.com" and enter in the search field the serial number of your instrument.
- Scan the QR code on the type label.
- Open the VEGA Tools app and enter the serial number under "**Documentation**".

3 Mounting

3.1 General instructions for use of the instrument

Protection against moisture

Protect your instrument against moisture ingress through the following measures:

- Use a suitable connection cable (see chapter "Connecting to power supply")
- Tighten the cable gland or plug connector
- Lead the connection cable downward in front of the cable entry or plug connector

This applies mainly to outdoor installations, in areas where high humidity is expected (e.g. through cleaning processes) and on cooled or heated vessels.



Note:

Make sure that during installation or maintenance no moisture or dirt can get inside the instrument.

To maintain the housing protection, make sure that the housing lid is closed during operation and locked, if necessary.

3.2 Ventilation and pressure compensation

Filter element - Position

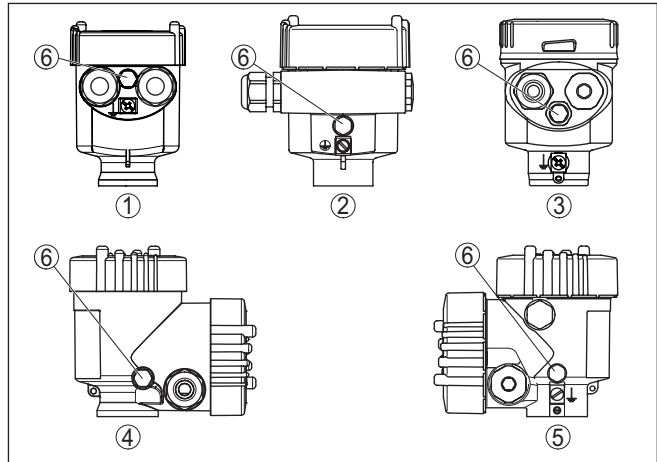

Fig. 1: Position of the filter element

- 1 Plastic, stainless steel single chamber (precision casting)
- 2 Aluminium - single chamber
- 3 Stainless steel single chamber (electropolished)
- 4 Plastic double chamber
- 5 Aluminium, stainless steel double chamber housing (precision casting)
- 6 Filter element

With the following instruments a blind plug is installed instead of the filter element:

- Instruments in protection IP66/IP68 (1 bar) - ventilation via capillaries in non-detachable cable
- Instruments with absolute pressure

4 Connecting to power supply

4.1 Connecting

Connection technology

The voltage supply and signal output are connected via the spring-loaded terminals in the housing.

Connection to the display and adjustment module or to the interface adapter is carried out via contact pins in the housing.



Information:

The terminal block is pluggable and can be removed from the electronics. To do this, lift the terminal block with a small screwdriver and pull it out. When reinserting the terminal block, you should hear it snap in.

Connection procedure

Proceed as follows:

1. Unscrew the housing lid
2. If a display and adjustment module is installed, remove it by turning it slightly to the left
3. Loosen compression nut of the cable gland and remove blind plug
4. Remove approx. 10 cm (4 in) of the cable mantle, strip approx. 1 cm (0.4 in) of insulation from the ends of the individual wires
5. Insert the cable into the sensor through the cable entry

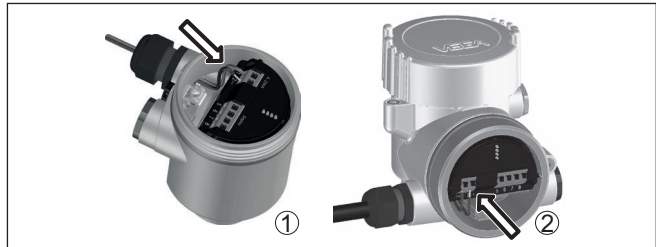

Fig. 2: Connection steps 5 and 6

- 1 Single chamber housing
- 2 Double chamber housing

6. Insert the wire ends into the terminals according to the wiring plan



Note:

Solid cores as well as flexible cores with wire end sleeves are inserted directly into the terminal openings. In case of flexible cores without end sleeves, press the terminal from above with a small screwdriver, the terminal opening is then free. When the screwdriver is released, the terminal closes again.

7. Check the hold of the wires in the terminals by lightly pulling on them
8. Connect the shielding to the internal ground terminal, connect the external ground terminal to potential equalisation

9. Tighten the compression nut of the cable entry gland. The seal ring must completely encircle the cable
 10. Reinsert the display and adjustment module, if one was installed
 11. Screw the housing lid back on
- The electrical connection is finished.

4.2 Single chamber housing

The following illustration applies to the non-Ex, Ex ia and Ex d version.

Electronics and connection compartment

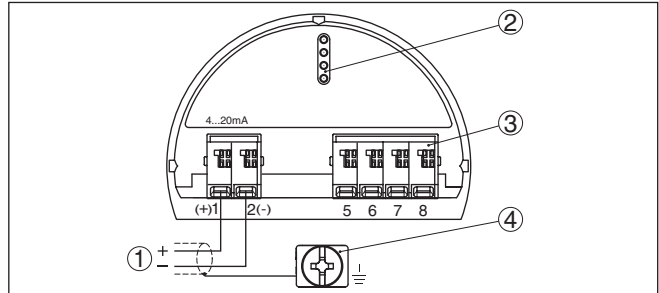

Fig. 3: Electronics and connection compartment - single chamber housing

- 1 Voltage supply, signal output
- 2 For display and adjustment module or interface adapter
- 3 For external display and adjustment unit or Secondary sensor
- 4 Ground terminal for connection of the cable screening

4.3 Double chamber housing

The following illustrations apply to the non-Ex as well as to the Ex-ia version.

Connection compartment

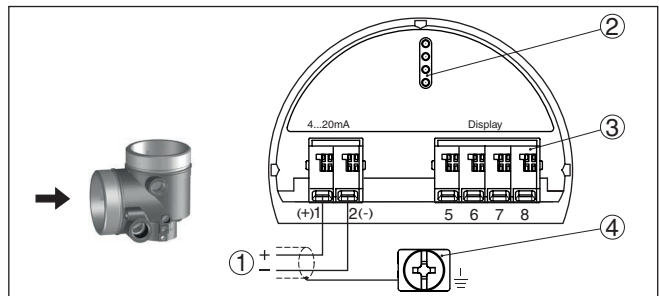

Fig. 4: Connection compartment - double chamber housing

- 1 Voltage supply, signal output
- 2 For display and adjustment module or interface adapter
- 3 For external display and adjustment unit
- 4 Ground terminal for connection of the cable screening

5 Set up with the display and adjustment module

5.1 Insert display and adjustment module

The display and adjustment module can be inserted into the sensor and removed again at any time. You can choose any one of four different positions - each displaced by 90°. It is not necessary to interrupt the power supply.

Proceed as follows:

1. Unscrew the housing lid
2. Place the display and adjustment module on the electronics in the desired position and turn it to the right until it snaps in.
3. Screw housing lid with inspection window tightly back on

Disassembly is carried out in reverse order.

The display and adjustment module is powered by the sensor, an additional connection is not necessary.



Fig. 5: Installing the display and adjustment module in the electronics compartment of the single chamber housing

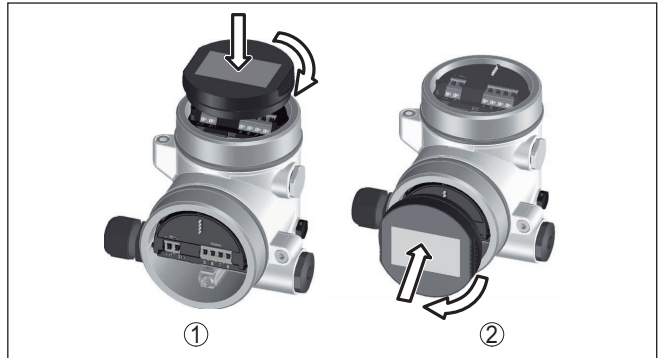

Fig. 6: Installing the display and adjustment module in the double chamber housing

- 1 In the electronics compartment
- 2 In the connection compartment



Note:

If you intend to retrofit the instrument with a display and adjustment module for continuous measured value indication, a higher lid with an inspection glass is required.

5.2 Parameter adjustment

Operating sequence

A parameter change with SIL qualified instruments must always be carried out as follows:

- Unlock adjustment
- Change parameters
- Lock adjustment and verify modified parameters

This ensures that all modified parameters have been deliberately changed.

Unlock adjustment

The instrument is shipped in locked condition.

To prevent unintentional or unauthorized adjustment, the instrument is protected (locked) against all parameter changes while in normal operating condition.

For each parameter change you have to enter the PIN of the instrument. In delivery status, the PIN is "0000".

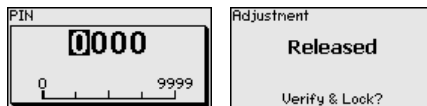

Change parameters

You can find a description below the respective parameter.

Lock adjustment and verify modified parameters

You can find a description below the parameter " *Setup - Lock adjustment*".

- Change setup parameters** 1. Go to the menu " *Setup*" via the display and adjustment module.

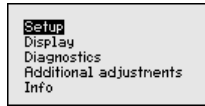

2. In this menu item you activate/deactivate the Secondary sensor for electronic differential pressure and select the application, e.g. level

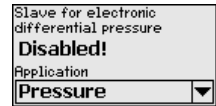
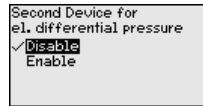
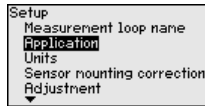

3. Select in the menu item " *Units*" the adjustment unit of the instrument, e.g. " *bar*".

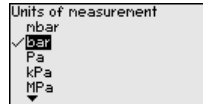
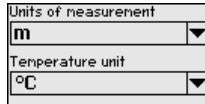

4. Depending on the application, carry out the adjustment e.g. in the menu items " *Min. adjustment*" and " *Max. adjustment*".

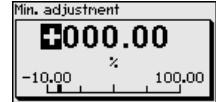
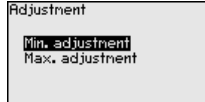

Parameterization example VEGABAR 83 always measures pressure independently of the process variable selected in the menu item " *Application*". To output the selected process variable correctly, an allocation of the output signal to 0 % and 100 % must be carried out (adjustment).

With the application " *Level*", the hydrostatic pressure, e.g. with full and empty vessel, is entered for adjustment. See following example:

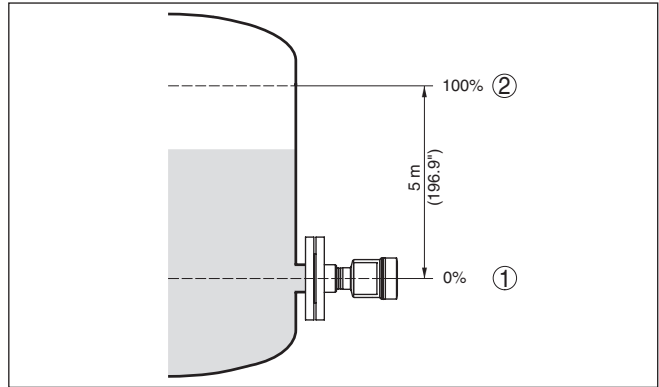

Fig. 7: Parameter adjustment example Min./max. adjustment, level measurement

- 1 Min. level = 0 % corresponds to 0.0 mbar
- 2 Max. level = 100 % corresponds to 490.5 mbar

If these values are not known, an adjustment with filling levels of e.g. 10 % and 90 % is also possible. By means of these settings, the real filling height is then calculated.

The actual product level during this adjustment is not important, because the min./max. adjustment is always carried out without changing the product level. These settings can be made ahead of time without the instrument having to be installed.

Lock adjustment

With this menu item you safeguard the sensor parameters against unauthorized or unintentional modifications.



To detect parameterization errors reliably, safety-relevant parameters must be verified before saving them into the instrument.

1. Enter PIN

In delivery status, the PIN is "0000".

2. Character string comparison

You then have to carry out the character string comparison. This is used to check the character presentation.

3. Serial number acknowledgement

Afterwards you confirm that the serial number of your instrument was carried over correctly. This is used to check device communication.

4. Verify parameters

Confirm the modified values one after the other.

If the described process of parameter adjustment was run through completely and correctly, the instrument will be locked and hence ready for operation.

5.3 Menu overview

The following tables show the adjustment menu of the instrument. Depending on the instrument version or application, all menu items may not be available or some may be differently assigned.

SIL The safety-relevant menu items having to do with functional safety according to IEC 61508 (Edition 2) are marked with " *SIL* ".

Setup

Menu item	Parameter	Default value
Measurement loop name	19 alphanumeric characters/special characters	Sensor
Application (SIL)	Application	Level
	Secondary sensor for electronic differential pressure	Deactivated
Units	Adjustment unit (m, bar, Pa, psi ... user-defined)	mbar (with nominal measuring range ≤ 400 mbar) bar (with nominal measuring ranges ≥ 1 bar)
	Temperature unit ($^{\circ}\text{C}$, $^{\circ}\text{F}$)	$^{\circ}\text{C}$
Position correction (SIL)		0.00 bar
Adjustment (SIL)	Zero/Min. adjustment	0.00 bar 0.00 %
	Span/Max. adjustment	Nominal measuring range in bar 100.00 %
Damping (SIL)	Integration time	1 s
Linearisation	Linear, cylindrical tank, ... user-defined	Linear
Current output (SIL)	Current output - Mode	
	Output characteristics: 4 ... 20 mA, 20 ... 4 mA	4 ... 20 mA
	Failure mode: ≤ 3.6 mA, ≥ 20 mA, last measured value	≤ 3.6 mA
	Current output - Min./Max.	
	Min. current: 3.8 mA, 4 mA	3.8 mA
	Max. current: 20 mA, 20.5 mA	20.5 mA
Lock adjustment (SIL)	Blocked, released	Last setting

Display

Menu item	Default value
Menu language	Selected language
Displayed value 1	Pressure
Displayed value 2	Ceramic measuring cell: Measuring cell temperature in $^{\circ}\text{C}$ Metallic measuring cell: Electronics temperature in $^{\circ}\text{C}$

Menu item	Default value
Display format	Number of positions after the decimal point, automatically
Backlight	Switched on

Diagnostics

Menu item	Parameter	Default value
Device status		No reset
Peak indicator	Pressure	Current pressure measured value
Peak indicator temp.	Temperature	Actual measuring cell and electronic temperature
Simulation	Measured value	Pressure
	Simulations	Not active
Proof test		No reset

Additional adjustments

Menu item	Parameter	Default value
Date/Time		No reset
Reset	Delivery status, basic settings	No reset
Copy instrument settings	Read from sensor, write into sensor	No reset
Scaling	Scaling size	Volume in l
	Scaling format	0 % corresponds to 0 l 100 % corresponds to 0 l Without decimal positions
Current output (SIL)	Current output - Meas. variable	Lin. percent - Level
	Current output - Adjustment	0 ... 100 % correspond to 4 ... 20 mA
Current output 2	Current output - Meas. variable	Measuring cell temperature
	Current output - Adjustment	0 ... 100 % correspond to 4 ... 20 mA
HART mode	HART address, current output	Address 00, analogue current output
Special parameter (SIL)	Service-Login	No reset

Info

Menu item	Parameter
Device name	VEGABAR 83
Instrument version	Hardware and software version
Factory calibration date	Date
Sensor characteristics	Order-specific characteristics

6 Set up with smartphone/tablet, PC/ notebook via Bluetooth

6.1 Preparations

Activate Bluetooth

Make sure that the Bluetooth function of the display and adjustment module is activated. For this, the switch on the bottom side must be set to "On".

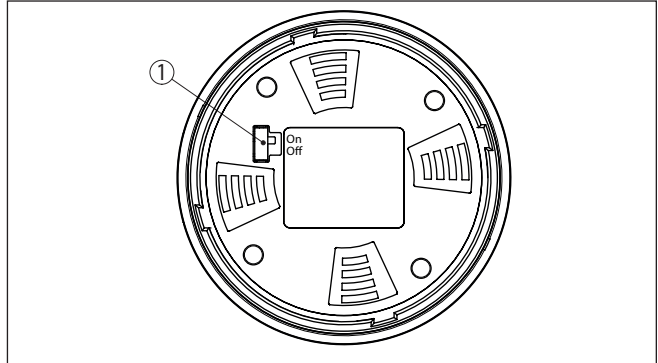

Fig. 8: Activate Bluetooth

1 Switch

On = Bluetooth active

Off = Bluetooth not active

Change sensor PIN

The security concept of Bluetooth operation absolutely requires that the default setting of the sensor PIN be changed. This prevents unauthorized access to the sensor.

The default setting of the sensor PIN is "0000". First of all you have to change the sensor PIN in the adjustment menu of the sensor, e.g. to "1111":

- Go to setup via the extended operation

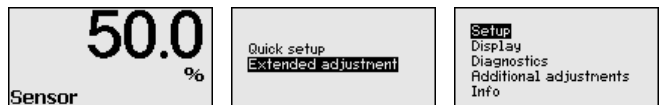

- Lock operation by changing sensor PIN

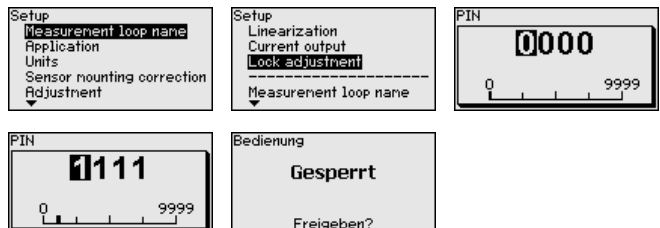

- Enable operation again by entering the sensor PIN once more

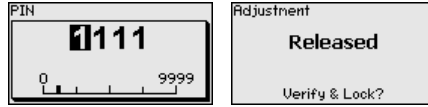

Sensor adjustment via the display/adjustment module or PACTware/DTM by means of VEGACONNECT is thus released again. For access (authentication) with Bluetooth, the changed PIN is still effective.



Note:

Bluetooth access can only be established if the current sensor PIN differs from the default setting "0000". It is possible both when the adjustment is unlocked and when it is locked.

6.2 Connecting

Preparations

Smartphone/Tablet

Start the adjustment app and select the function "Setup". The smartphone/tablet searches automatically for Bluetooth-capable instruments in the area.

PC/Notebook

Start PACTware and the VEGA project assistant. Select the device search via Bluetooth and start the search function. The device automatically searches for Bluetooth-capable devices in the vicinity.

Connecting

The message "*Instrument search running*" is displayed. All devices found are listed in the operating window. The search is automatically continued continuously.

Select in the device list the requested device. The message "*Connecting*" is displayed.

Authenticate

For the first connection, the operating device and the sensor must authenticate each other. After successful authentication, the next connection functions without authentication.

For authentication, enter in the next menu window the 4-digit sensor PIN.

6.3 Sensor parameter adjustment

The sensor parameterization is carried out via the adjustment app on the smartphone/tablet or the DTM on the PC/notebook.

App view

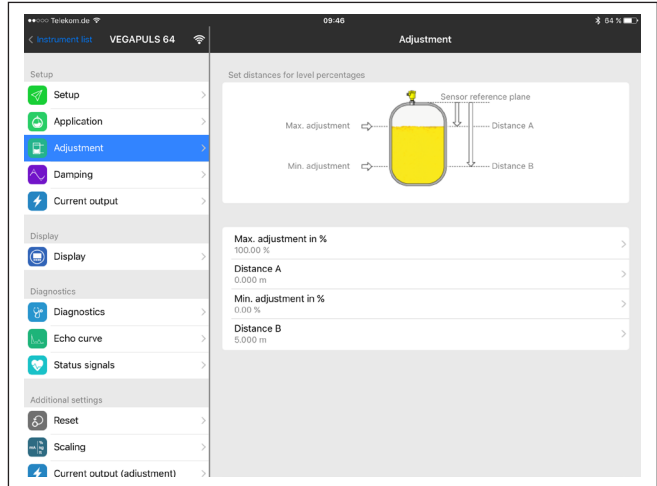

Fig. 9: Example of an app view - Setup sensor adjustment

7 Supplement

7.1 Technical data

Note for approved instruments

The technical data in the respective safety instructions which are included in delivery are valid for approved instruments (e.g. with Ex approval). These data can differ from the data listed herein, for example regarding the process conditions or the voltage supply.

All approval documents can be downloaded from our homepage.

Electromechanical data - version IP66/IP67 and IP66/IP68 (0.2 bar)²⁾

Options of the cable entry

- Cable entry M20 x 1.5; ½ NPT
- Cable gland M20 x 1.5; ½ NPT (cable ø see below table)
- Blind plug M20 x 1.5; ½ NPT
- Closing cap ½ NPT

Material cable gland/Seal insert	Cable diameter			
	5 ... 9 mm	6 ... 12 mm	7 ... 12 mm	10 ... 14 mm
PA/NBR	√	√	-	√
Brass, nickel-plated/NBR	√	√	-	-
Stainless steel/NBR	-	-	√	-

Wire cross-section (spring-loaded terminals)

- Massive wire, stranded wire 0.2 ... 2.5 mm² (AWG 24 ... 14)
- Stranded wire with end sleeve 0.2 ... 1.5 mm² (AWG 24 ... 16)

Voltage supply

Operating voltage U_B 9.6 ... 35 V DC

Operating voltage U_B with lighting switched on 16 ... 35 V DC

Reverse voltage protection Integrated

Permissible residual ripple

- for U_N 12 V DC ($9.6 V < U_B < 14 V$) $\leq 0.7 V_{eff}$ (16 ... 400 Hz)
- for U_N 24 V DC ($18 V < U_B < 35 V$) $\leq 1.0 V_{eff}$ (16 ... 400 Hz)

Load resistor

- Calculation $(U_B - U_{min})/0.022 A$
- Example - with $U_B = 24 V$ DC $(24 V - 9.6 V)/0.022 A = 655 \Omega$

²⁾ IP66/IP68 (0.2 bar), only with absolute pressure.

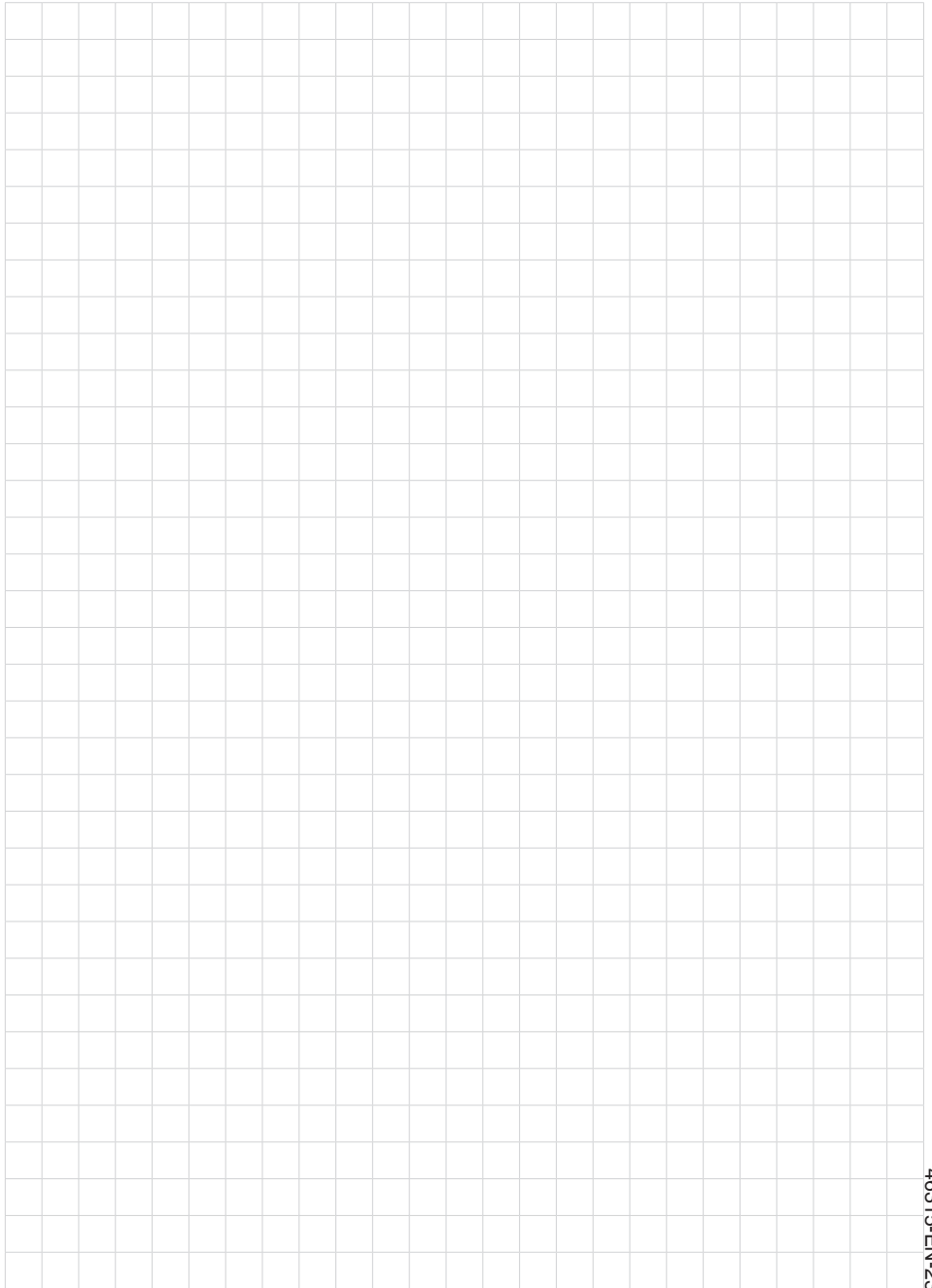



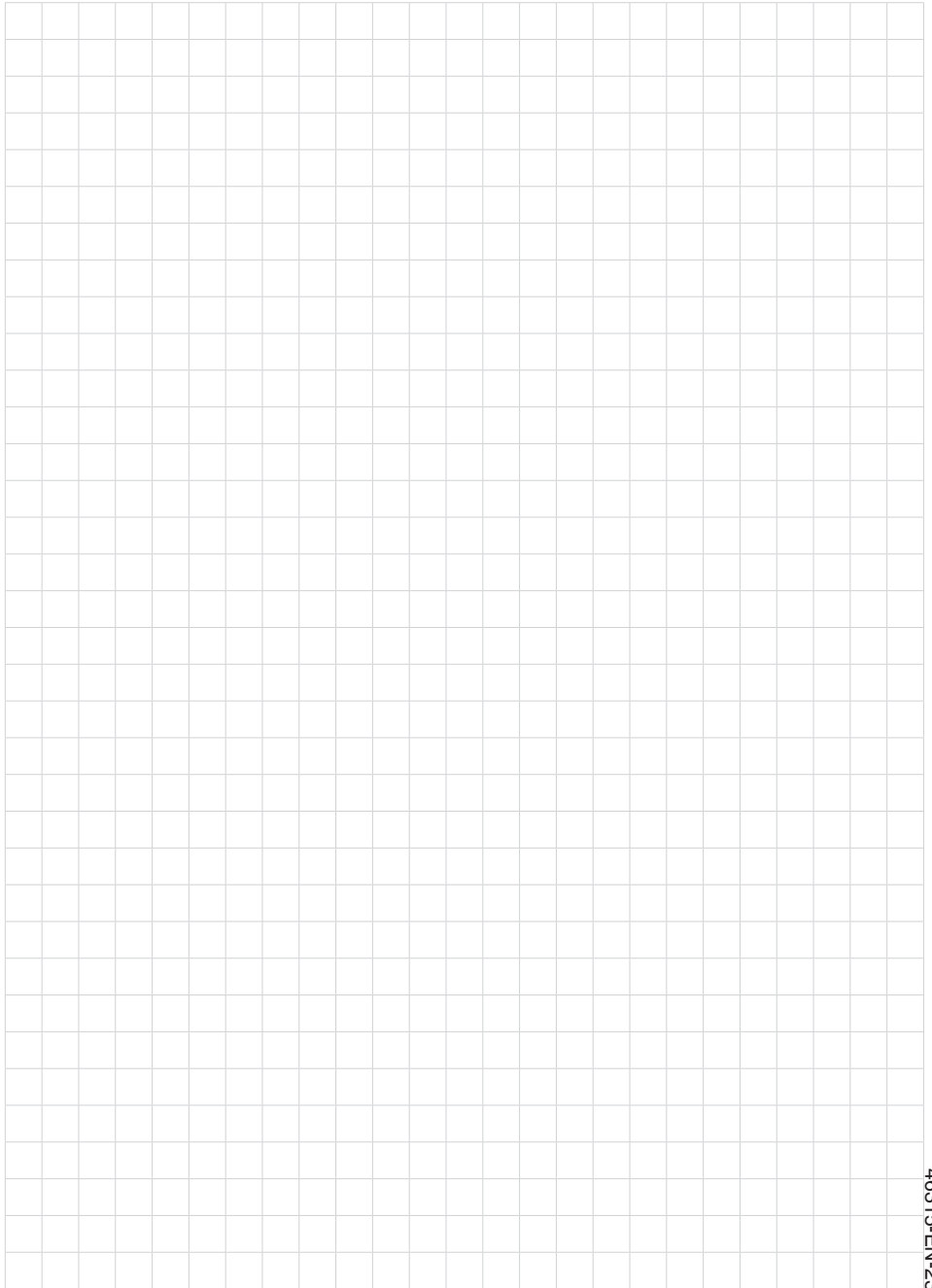



Printing date:

VEGA

All statements concerning scope of delivery, application, practical use and operating conditions of the sensors and processing systems correspond to the information available at the time of printing.

Subject to change without prior notice

© VEGA Grieshaber KG, Schiltach/Germany 2023



46315-EN-230914

VEGA Grieshaber KG
Am Hohenstein 113
77761 Schiltach
Germany

Phone +49 7836 50-0
E-mail: info.de@vega.com
www.vega.com