

# Operating Instructions

TDR sensor for continuous level and interface measurement of liquids

## VEGAFLEX 83

Foundation Fieldbus

PFA coated rod and cable probe



Document ID: 44227



**VEGA**

# Contents

<b>1</b>	<b>About this document</b> .....	<b>4</b>
1.1	Function .....	4
1.2	Target group .....	4
1.3	Symbols used.....	4
<b>2</b>	<b>For your safety</b> .....	<b>5</b>
2.1	Authorised personnel .....	5
2.2	Appropriate use.....	5
2.3	Warning about incorrect use.....	5
2.4	General safety instructions .....	5
2.5	Conformity.....	5
2.6	NAMUR recommendations .....	6
2.7	Installation and operation in the USA and Canada .....	6
2.8	Environmental instructions .....	6
<b>3</b>	<b>Product description</b> .....	<b>7</b>
3.1	Configuration.....	7
3.2	Principle of operation.....	9
3.3	Packaging, transport and storage.....	11
3.4	Accessories.....	11
<b>4</b>	<b>Mounting</b> .....	<b>13</b>
4.1	General instructions .....	13
4.2	Mounting instructions .....	14
<b>5</b>	<b>Connecting to power supply</b> .....	<b>19</b>
5.1	Preparing the connection .....	19
5.2	Connecting.....	20
5.3	Wiring plan, single chamber housing.....	21
5.4	Wiring plan, double chamber housing .....	21
5.5	Double chamber housing with VEGADIS-Adapter .....	23
5.6	Wiring plan - version IP66/IP68 (1 bar).....	24
5.7	Switch-on phase.....	24
<b>6</b>	<b>Set up with the display and adjustment module</b> .....	<b>25</b>
6.1	Insert display and adjustment module .....	25
6.2	Adjustment system .....	26
6.3	Parameter adjustment - Quick setup .....	28
6.4	Parameter adjustment - Extended adjustment.....	28
6.5	Save parameter adjustment data.....	44
<b>7</b>	<b>Set up with smartphone/tablet/PC/notebook via Bluetooth</b> .....	<b>45</b>
7.1	Preparations.....	45
7.2	Connecting.....	46
7.3	Sensor parameter adjustment.....	47
<b>8</b>	<b>Setup with PACTware</b> .....	<b>48</b>
8.1	Connect the PC.....	48
8.2	Parameter adjustment with PACTware.....	48
8.3	Set up with the quick setup.....	49
8.4	Save parameter adjustment data.....	51
<b>9</b>	<b>Set up with other systems</b> .....	<b>52</b>
9.1	DD adjustment programs .....	52

9.2	Field Communicator 375, 475 .....	52
<b>10</b>	<b>Diagnosis, asset management and service .....</b>	<b>53</b>
10.1	Maintenance .....	53
10.2	Measured value and event memory .....	53
10.3	Asset Management function.....	54
10.4	Rectify faults.....	57
10.5	Exchanging the electronics module.....	62
10.6	Software update .....	63
10.7	How to proceed if a repair is necessary.....	63
<b>11</b>	<b>Dismount.....</b>	<b>65</b>
11.1	Dismounting steps.....	65
11.2	Disposal .....	65
<b>12</b>	<b>Supplement .....</b>	<b>66</b>
12.1	Technical data .....	66
12.2	Device communication Foundation Fieldbus.....	74
12.3	Dimensions .....	78
12.4	Industrial property rights.....	84
12.5	Trademark.....	84



**Safety instructions for Ex areas:**

Take note of the Ex specific safety instructions for Ex applications. These instructions are attached as documents to each instrument with Ex approval and are part of the operating instructions.

Editing status: 2023-05-23

# 1 About this document

## 1.1 Function

This instruction provides all the information you need for mounting, connection and setup as well as important instructions for maintenance, fault rectification, the exchange of parts and the safety of the user. Please read this information before putting the instrument into operation and keep this manual accessible in the immediate vicinity of the device.

## 1.2 Target group

This operating instructions manual is directed to trained personnel. The contents of this manual must be made available to the qualified personnel and implemented.

## 1.3 Symbols used



### Document ID

This symbol on the front page of this instruction refers to the Document ID. By entering the Document ID on [www.vega.com](http://www.vega.com) you will reach the document download.



**Information, note, tip:** This symbol indicates helpful additional information and tips for successful work.



**Note:** This symbol indicates notes to prevent failures, malfunctions, damage to devices or plants.



**Caution:** Non-observance of the information marked with this symbol may result in personal injury.



**Warning:** Non-observance of the information marked with this symbol may result in serious or fatal personal injury.



**Danger:** Non-observance of the information marked with this symbol results in serious or fatal personal injury.



### Ex applications

This symbol indicates special instructions for Ex applications.



### List

The dot set in front indicates a list with no implied sequence.



### Sequence of actions

Numbers set in front indicate successive steps in a procedure.



### Disposal

This symbol indicates special instructions for disposal.

## 2 For your safety

### 2.1 Authorised personnel

All operations described in this documentation must be carried out only by trained, qualified personnel authorised by the plant operator.

During work on and with the device, the required personal protective equipment must always be worn.

### 2.2 Appropriate use

VEGAFLEX 83 is a sensor for continuous level measurement.

You can find detailed information about the area of application in chapter " *Product description*".

Operational reliability is ensured only if the instrument is properly used according to the specifications in the operating instructions manual as well as possible supplementary instructions.

### 2.3 Warning about incorrect use

Inappropriate or incorrect use of this product can give rise to application-specific hazards, e.g. vessel overflow through incorrect mounting or adjustment. Damage to property and persons or environmental contamination can result. Also, the protective characteristics of the instrument can be impaired.

### 2.4 General safety instructions

This is a state-of-the-art instrument complying with all prevailing regulations and directives. The instrument must only be operated in a technically flawless and reliable condition. The operator is responsible for the trouble-free operation of the instrument. When measuring aggressive or corrosive media that can cause a dangerous situation if the instrument malfunctions, the operator has to implement suitable measures to make sure the instrument is functioning properly.

The safety instructions in this operating instructions manual, the national installation standards as well as the valid safety regulations and accident prevention rules must be observed by the user.

For safety and warranty reasons, any invasive work on the device beyond that described in the operating instructions manual may be carried out only by personnel authorised by the manufacturer. Arbitrary conversions or modifications are explicitly forbidden. For safety reasons, only the accessory specified by the manufacturer must be used.

To avoid any danger, the safety approval markings and safety tips on the device must also be observed.

### 2.5 Conformity

The device complies with the legal requirements of the applicable country-specific directives or technical regulations. We confirm conformity with the corresponding labelling.

The corresponding conformity declarations can be found on our homepage.

### **Electromagnetic compatibility**

Instruments in four-wire or Ex d ia version are designed for use in an industrial environment. Nevertheless, electromagnetic interference from electrical conductors and radiated emissions must be taken into account, as is usual with class A instruments according to EN 61326-1. If the instrument is used in a different environment, the electromagnetic compatibility to other instruments must be ensured by suitable measures.

## **2.6 NAMUR recommendations**

NAMUR is the automation technology user association in the process industry in Germany. The published NAMUR recommendations are accepted as the standard in field instrumentation.

The device fulfils the requirements of the following NAMUR recommendations:

- NE 21 – Electromagnetic compatibility of equipment
- NE 53 – Compatibility of field devices and display/adjustment components
- NE 107 – Self-monitoring and diagnosis of field devices

For further information see [www.namur.de](http://www.namur.de).

## **2.7 Installation and operation in the USA and Canada**

This information is only valid for USA and Canada. Hence the following text is only available in the English language.

Installations in the US shall comply with the relevant requirements of the National Electrical Code (NEC - NFPA 70) (USA).

Installations in Canada shall comply with the relevant requirements of the Canadian Electrical Code (CEC Par I) (Canada).

## **2.8 Environmental instructions**

Protection of the environment is one of our most important duties. That is why we have introduced an environment management system with the goal of continuously improving company environmental protection. The environment management system is certified according to DIN EN ISO 14001.

Please help us fulfil this obligation by observing the environmental instructions in this manual:

- Chapter " *Packaging, transport and storage* "
- Chapter " *Disposal* "

## 3 Product description

### 3.1 Configuration

#### Scope of delivery

The scope of delivery encompasses:

- Sensor VEGAFLEX 83
- Optional accessory
- Optionally integrated Bluetooth module

The further scope of delivery encompasses:

- Documentation
  - Quick setup guide VEGAFLEX 83
  - Instructions for optional instrument features
  - Ex-specific "*Safety instructions*" (with Ex versions)
  - If necessary, further certificates



#### Information:

Optional instrument features are also described in this operating instructions manual. The respective scope of delivery results from the order specification.

#### Scope of this operating instructions

This operating instructions manual applies to the following instrument versions:

- Hardware from 1.0.0
- Software from 1.3.0
- Only for instrument versions without SIL qualification

#### Type label

The type label contains the most important data for identification and use of the instrument:

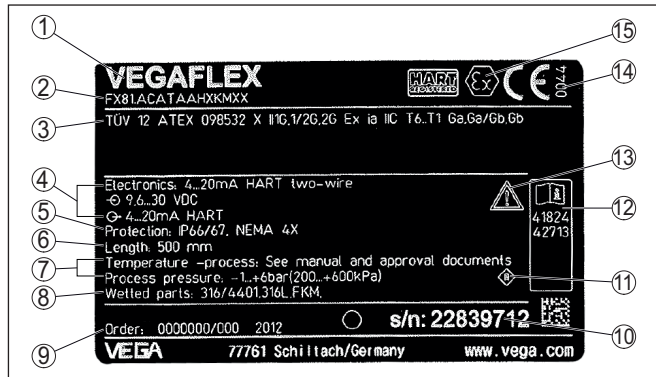

Fig. 1: Layout of the type label (example)

- 1 Instrument type
- 2 Product code
- 3 Approvals
- 4 Power supply and signal output, electronics
- 5 Protection rating
- 6 Probe length (measurement accuracy optional)
- 7 Process and ambient temperature, process pressure
- 8 Material wetted parts
- 9 Order number
- 10 Serial number of the instrument
- 11 Symbol of the device protection class
- 12 ID numbers, instrument documentation
- 13 Reminder to observe the instrument documentation
- 14 Notified authority for CE marking
- 15 Approval directives

### Serial number - Instrument search

The type label contains the serial number of the instrument. With it you can find the following instrument data on our homepage:

- Product code (HTML)
- Delivery date (HTML)
- Order-specific instrument features (HTML)
- Operating instructions and quick setup guide at the time of shipment (PDF)
- Test certificate (PDF) - optional

Move to "[www.vega.com](http://www.vega.com)" and enter in the search field the serial number of your instrument.

Alternatively, you can access the data via your smartphone:

- Download the VEGA Tools app from the "Apple App Store" or the "Google Play Store"
- Scan the QR-code on the type label of the device or
- Enter the serial number manually in the app



### 3.2 Principle of operation

**Application area**

The VEGAFLEX 83 is a level sensor with coated cable or rod probe for continuous level or interface measurement, particularly suitable for applications in the chemical industry.

**Functional principle - level measurement**

High frequency microwave pulses are guided along a steel cable or a rod. Upon reaching the medium surface, the microwave pulses are reflected. The running time is evaluated by the instrument and output as level.

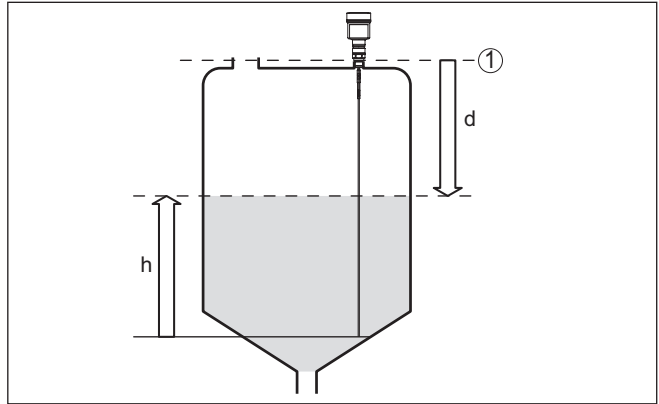

Fig. 2: Level measurement

- 1 Sensor reference plane (seal surface of the process fitting)
- d Distance to the level
- h Height - Level

**Functional principle - interface measurement**

High frequency microwave impulses are guided along a steel cable or rod. Upon reaching the medium surface, a part of the microwave impulses is reflected. The other part passes through the upper product and is reflected by the interface. The running times to the two product layers are processed by the instrument.

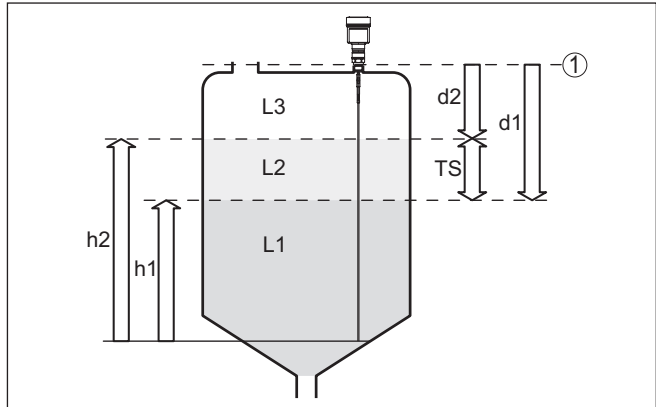

Fig. 3: Interface measurement

- 1 Sensor reference plane (seal surface of the process fitting)  
 d1 Distance to the interface  
 d2 Distance to the level  
 TS Thickness of the upper medium ( $d1 - d2$ )  
 h1 Height - Interface  
 h2 Height - Level  
 L1 Lower medium  
 L2 Upper medium  
 L3 Gas phase

### Prerequisites for interface measurement

#### Upper medium (L2)

- The upper medium must not be conductive
- The dielectric constant of the upper medium or the actual distance to the interface must be known (input required). Min. dielectric constant: 1.6. You can find a list of dielectric constants on our home page: [www.vega.com](http://www.vega.com).
- The composition of the upper medium must be stable, no varying products or mixtures
- The upper medium must be homogeneous, no stratifications within the medium
- Min. thickness of the upper medium 50 mm (1.97 in)
- Clear separation from the lower medium, emulsion phase or detritus layer max. 50 mm (1.97 in)
- If possible, no foam on the surface

#### Lower medium (L1)

- The dielectric constant must be 10 higher than the dielectric constant of the upper medium, preferably electrically conductive. Example: upper medium dielectric constant 2, lower medium at least dielectric constant 12.

#### Gas phase (L3)

- Air or gas mixture
- Gas phase - dependent on the application, gas phase does not always exist ( $d2 = 0$ )

<b>Output signal</b>	<p>The instrument is always preset to the application " <i>Level measurement</i>".</p> <p>For the interface measurement, you can select the requested output signal with the setup.</p>
<b>Packaging</b>	<p><b>3.3 Packaging, transport and storage</b></p> <p>Your instrument was protected by packaging during transport. Its capacity to handle normal loads during transport is assured by a test based on ISO 4180.</p> <p>The packaging consists of environment-friendly, recyclable cardboard. For special versions, PE foam or PE foil is also used. Dispose of the packaging material via specialised recycling companies.</p>
<b>Transport</b>	<p>Transport must be carried out in due consideration of the notes on the transport packaging. Nonobservance of these instructions can cause damage to the device.</p>
<b>Transport inspection</b>	<p>The delivery must be checked for completeness and possible transit damage immediately at receipt. Ascertained transit damage or concealed defects must be appropriately dealt with.</p>

<b>Storage</b>	<p>Up to the time of installation, the packages must be left closed and stored according to the orientation and storage markings on the outside.</p> <p>Unless otherwise indicated, the packages must be stored only under the following conditions:</p> <ul style="list-style-type: none"> <li>● Not in the open</li> <li>● Dry and dust free</li> <li>● Not exposed to corrosive media</li> <li>● Protected against solar radiation</li> <li>● Avoiding mechanical shock and vibration</li> </ul>
<b>Storage and transport temperature</b>	<ul style="list-style-type: none"> <li>● Storage and transport temperature see chapter " <i>Supplement - Technical data - Ambient conditions</i>"</li> <li>● Relative moisture 20 ... 85 %</li> </ul>

<b>Lifting and carrying</b>	<p>With instrument weights of more than 18 kg (39.68 lbs) suitable and approved equipment must be used for lifting and carrying.</p>
-----------------------------	--

**3.4 Accessories**

The instructions for the listed accessories can be found in the download area on our homepage.

<b>Display and adjustment module</b>	<p>The display and adjustment module is used for measured value indication, adjustment and diagnosis.</p> <p>The integrated Bluetooth module (optional) enables wireless adjustment via standard adjustment devices.</p>
--------------------------------------	--

<b>VEGACONNECT</b>	<p>The interface adapter VEGACONNECT enables the connection of communication-capable instruments to the USB interface of a PC.</p>
--------------------	--

<b>VEGADIS 81</b>	The VEGADIS 81 is an external display and adjustment unit for VEGAFLEX <sup>®</sup> sensors.
<b>VEGADIS adapter</b>	The VEGADIS adapter is an accessory part for sensors with double chamber housing. It enables the connection of VEGADIS 81 to the sensor housing via an M12 x 1 plug.
<b>Protective cover</b>	The protective cover protects the sensor housing against soiling and intense heat from solar radiation.
<b>Flanges</b>	Screwed flanges are available in different versions according to the following standards: DIN 2501, EN 1092-1, BS 10, ASME B 16.5, JIS B 2210-1984, GOST 12821-80.
<b>External housing</b>	<p>If the standard sensor housing is too big or in case of strong vibrations, an external housing can be used.</p> <p>Then the sensor housing is made of stainless steel. The electronics is located in the external housing which can be mounted in a distance of up to 10 m (32.8 ft) to the sensor by using a connection cable.</p>
<b>Centering</b>	If you mount the VEGAFLEX 83 in a bypass tube or standpipe, you have to avoid contact to the bypass tube by using a spacer at the probe end.

## 4 Mounting

### 4.1 General instructions

#### Protection against moisture

Protect your instrument against moisture ingress through the following measures:

- Use a suitable connection cable (see chapter " *Connecting to power supply*")
- Tighten the cable gland or plug connector
- Lead the connection cable downward in front of the cable entry or plug connector

This applies mainly to outdoor installations, in areas where high humidity is expected (e.g. through cleaning processes) and on cooled or heated vessels.



#### Note:

Make sure that during installation or maintenance no moisture or dirt can get inside the instrument.

To maintain the housing protection, make sure that the housing lid is closed during operation and locked, if necessary.

#### Cable glands

#### Metric threads

In the case of instrument housings with metric thread, the cable glands are screwed in at the factory. They are sealed with plastic plugs as transport protection.

You have to remove these plugs before electrical connection.

#### NPT thread

In the case of instrument housings with self-sealing NPT threads, it is not possible to have the cable entries screwed in at the factory. The free openings for the cable glands are therefore covered with red dust protection caps as transport protection. The dust protection caps do not provide sufficient protection against moisture.

Prior to setup you have to replace these protective caps with approved cable glands or close the openings with suitable blind plugs.

#### Process conditions



#### Note:

For safety reasons, the instrument must only be operated within the permissible process conditions. You can find detailed information on the process conditions in chapter " *Technical data*" of the operating instructions or on the type label.

Hence make sure before mounting that all parts of the instrument exposed to the process are suitable for the existing process conditions.

These are mainly:

- Active measuring component
- Process fitting
- Process seal

Process conditions in particular are:

- Process pressure
- Process temperature

- Chemical properties of the medium
- Abrasion and mechanical influences

## 4.2 Mounting instructions

### Installation position

Mount the device in such a way that the distance to vessel installations or to the vessel wall is at least 300 mm (12 in). In non-metallic vessels, the distance to the vessel wall should be at least 500 mm (19.7 in).

During operation, the probe must not touch any installations or the vessel wall. If necessary, fasten the probe end.

In vessels with conical bottom it can be advantageous to mount the device in the center of the vessel, as measurement is then possible nearly down to the lowest point of the bottom. Keep in mind that measurement all the way down to the tip of the probe may not be possible. The exact value of the min. distance (lower blocking distance) is stated in chapter " *Technical data*" of the operating instructions.

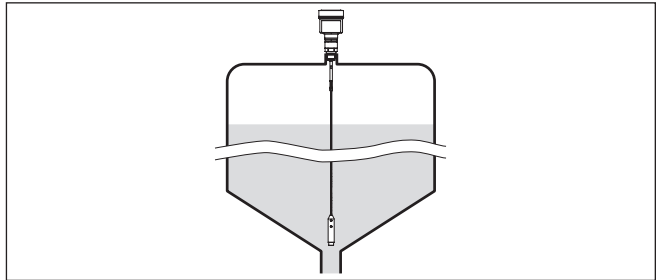

Fig. 4: Vessel with conical bottom

### Type of vessel

#### Plastic vessel/Glass vessel

The guided microwave principle requires a metallic surface on the process fitting. Therefore, in plastic vessels, etc., use an instrument version with flange (from DN 50) or place a metal sheet ( $\varnothing > 200$  mm/8 in) beneath the process fitting when screwing it in.

Make sure that the plate has direct contact with the process fitting.

When mounting rod or cable probes in vessels without metal walls, e.g. in plastic vessels, the measured value can be influenced by strong electromagnetic fields (emitted interference according to EN 61326: class A). In this case, use a probe with coaxial version.

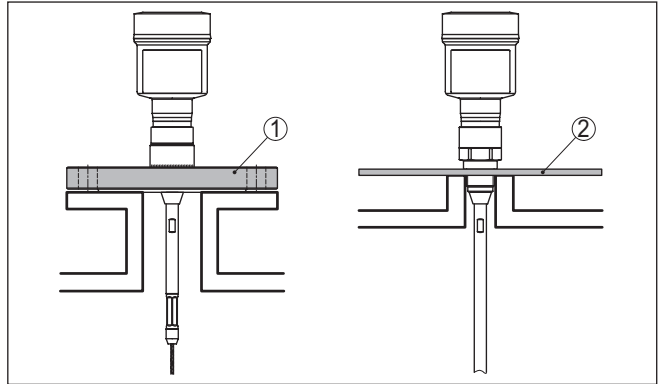

Fig. 5: Mounting in non-metallic vessel

- 1 Flange
- 2 Metal sheet

**Nozzle**

If possible, avoid nozzles. Mount the sensor flush with the vessel top. If this is not possible, use short nozzles with small diameter.

Higher nozzles or nozzles with a bigger diameter can generally be used. They can, however, increase the upper blocking distance. Check if this is relevant for your measurement.

In such cases, always carry out a false signal suppression after mounting. You can find further information under "Setup procedure".

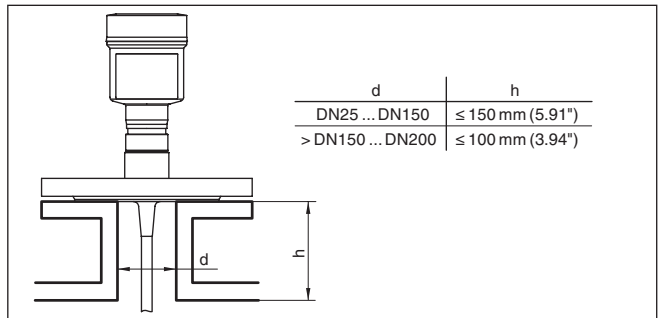

Fig. 6: Mounting socket

When welding the nozzle, make sure that the nozzle is flush with the vessel top.

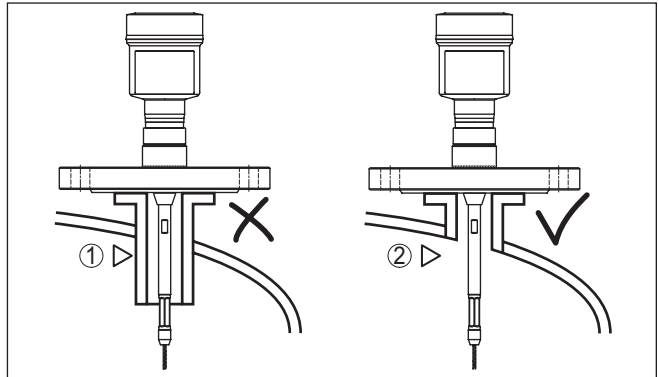

Fig. 7: Nozzle must be installed flush

- 1 Unfavourable mounting
- 2 Nozzle flush - optimum mounting

### Welding work

Before beginning the welding work, remove the electronics module from the sensor. By doing this, you avoid damage to the electronics through inductive coupling.

### Inflowing medium

Do not mount the instruments in or above the filling stream. Make sure that you detect the medium surface, not the inflowing product.

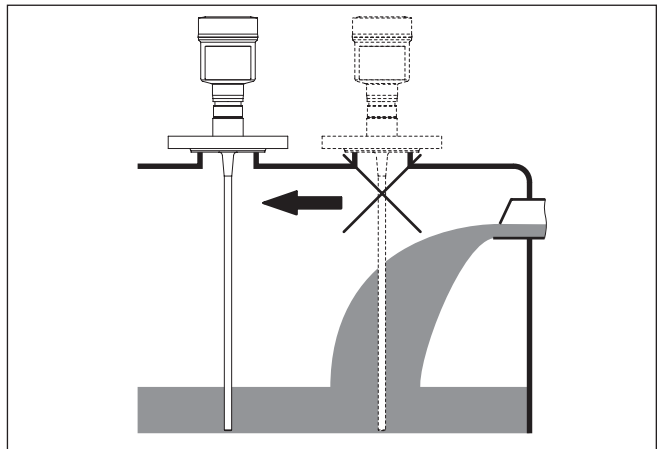

Fig. 8: Mounting of the sensor with inflowing medium

### Measuring range

The reference plane for the measuring range of the sensors is the sealing surface of the thread or flange.

Keep in mind that a min. distance must be maintained below the reference plane and possibly also at the end of the probe - measurement in these areas is not possible (blocking distance). The length of the cable can be used all the way to the end only when measuring



conductive products. These blocking distances for different mediums are listed in chapter " *Technical data*". Keep in mind for the adjustment that the default setting for the measuring range refers to water.

**Pressure**

The process fitting must be sealed if there is gauge or low pressure in the vessel. Before use, check if the sealing material is resistant against the measured product and the process temperature.

The max. permissible pressure is specified in chapter " *Technical data*" or on the type label of the sensor.

**Lateral installation**

In case of difficult installation conditions, the probe can also be mounted laterally. For this, adapt the rod with rod extensions or angled segments.

To compensate for the resulting changes in signal runtime, let the instrument determine the probe length automatically.

The determined probe length can deviate from the actual probe length when using curved or angled segments.

If internal installations such as struts, ladders, etc. are present on the vessel wall, the measuring probe should be mounted at least 300 mm (11.81 in) away from the vessel wall.

You can find further information in the supplementary instructions of the rod extension.

**Rod extension**

In case of difficult installation conditions, for example in a nozzle, the probe can be suitably adapted with a rod extension.

To compensate for the resulting changes in signal runtime, let the instrument determine the probe length automatically.

You can find further information in the supplementary instructions of the rod and cable components.

**Torque with PTFE plated flanges**

The PTFE washer of the antenna encapsulation serves also as process seal.

To compensate the normal prestress loss due to the seal materials, you have to use also disc springs in addition to the flange screws for fastening PTFE plated flanges.

We recommend flexible retaining washers (e.g. Schnorr VS or S) or detent edged rings (e.g. Gross VS KD).

Suitable retaining elements are also available from us.

Size	Article no.	Type
M16, 7/8"	32880	Detent edged ring Gross VS KD
M20, 3/4"	32881	Detent edged ring Gross VS KD
M24, 5/8"	32882	Retaining washer Schnorr VS, Schnorr S

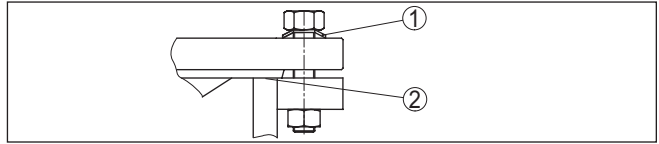

Fig. 9: Use of disc springs

- 1 Single disc spring
- 2 Sealing surface

The flange screws of VEGAFLEX 83 must be tightened with a torque of approx. 60 Nm (44 lbf ft) so that the PTFE washer seals reliably.



**Note:**

We recommend, retightening the screws in regular intervals depending on process pressure and temperature

## 5 Connecting to power supply

### 5.1 Preparing the connection

#### Safety instructions

Always keep in mind the following safety instructions:

- Carry out electrical connection by trained, qualified personnel authorised by the plant operator
- If overvoltage surges are expected, overvoltage arresters should be installed



#### Warning:

Only connect or disconnect in de-energized state.

#### Voltage supply

The instrument requires a operating voltage of 9 ... 32 V DC. Operating voltage and the digital bus signal are carried on the same two-wire connection cable. Power is supplied via the H1 power supply.

#### Connection cable

Connection is carried out with shielded cable according to Fieldbus specification.

Use cable with round cross section for instruments with housing and cable gland. To ensure the seal effect of the cable gland (IP protection rating), find out which cable outer diameter the cable gland is suitable for.

Use a cable gland fitting the cable diameter.

Make sure that the entire installation is carried out according to the Fieldbus specification. In particular, make sure that the bus is terminated with suitable terminating resistors.

#### Cable glands

#### Metric threads:

In the case of instrument housings with metric thread, the cable glands are screwed in at the factory. They are sealed with plastic plugs as transport protection.



#### Note:

You have to remove these plugs before electrical connection.

#### NPT thread:

In the case of instrument housings with self-sealing NPT threads, it is not possible to have the cable entries screwed in at the factory. The free openings for the cable glands are therefore covered with red dust protection caps as transport protection.



#### Note:

Prior to setup you have to replace these protective caps with approved cable glands or close the openings with suitable blind plugs.

On plastic housings, the NPT cable gland or the Conduit steel tube must be screwed into the threaded insert without grease.

Max. torque for all housings, see chapter " *Technical data*".

#### Cable screening and grounding

Make sure that the cable screen and grounding are carried out according to Fieldbus specification. We recommend to connect the cable screening to ground potential on both ends.

In systems with potential equalisation, connect the cable screening directly to ground potential at the power supply unit, in the connection box and at the sensor. The screen in the sensor must be connected directly to the internal ground terminal. The ground terminal outside on the housing must be connected to the potential equalisation (low impedance).

## 5.2 Connecting

### Connection technology

The voltage supply and signal output are connected via the spring-loaded terminals in the housing.

Connection to the display and adjustment module or to the interface adapter is carried out via contact pins in the housing.



#### Information:

The terminal block is pluggable and can be removed from the electronics. To do this, lift the terminal block with a small screwdriver and pull it out. When reinserting the terminal block, you should hear it snap in.

### Connection procedure

Proceed as follows:

1. Unscrew the housing lid
2. If a display and adjustment module is installed, remove it by turning it slightly to the left
3. Loosen compression nut of the cable gland and remove blind plug
4. Remove approx. 10 cm (4 in) of the cable mantle, strip approx. 1 cm (0.4 in) of insulation from the ends of the individual wires
5. Insert the cable into the sensor through the cable entry

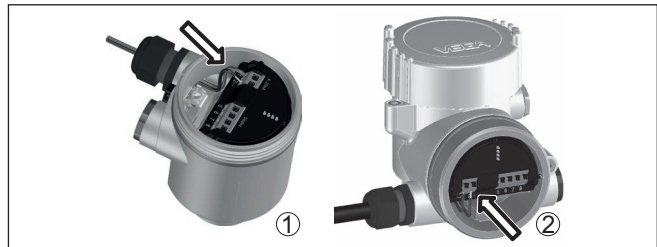

Fig. 10: Connection steps 5 and 6

- 1 Single chamber housing
- 2 Double chamber housing

6. Insert the wire ends into the terminals according to the wiring plan



#### Note:

Solid cores as well as flexible cores with wire end sleeves are inserted directly into the terminal openings. In case of flexible cores without end sleeves, press the terminal from above with a small screwdriver, the terminal opening is then free. When the screwdriver is released, the terminal closes again.

7. Check the hold of the wires in the terminals by lightly pulling on them
  8. Connect the shielding to the internal ground terminal, connect the external ground terminal to potential equalisation
  9. Tighten the compression nut of the cable entry gland. The seal ring must completely encircle the cable
  10. Reinsert the display and adjustment module, if one was installed
  11. Screw the housing lid back on
- The electrical connection is finished.

### 5.3 Wiring plan, single chamber housing

The following illustration applies to the non-Ex, Ex ia and Ex d version.

Electronics and connection compartment

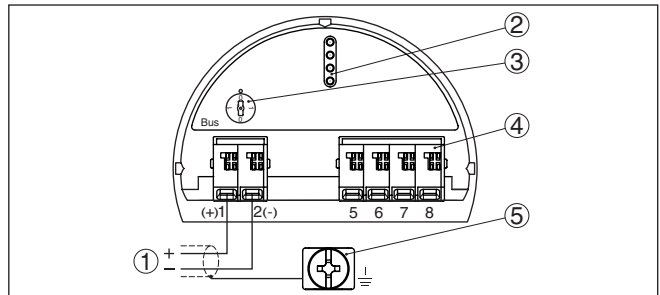

Fig. 11: Electronics and connection compartment - single chamber housing

- 1 Voltage supply, signal output
- 2 Contact pins for the display and adjustment module or interface adapter
- 3 Simulation switch ("1" = mode for simulation release)
- 4 For external display and adjustment unit
- 5 Ground terminal for connection of the cable screening

### 5.4 Wiring plan, double chamber housing

The following illustration applies to the non-Ex, Ex ia and Ex d version.



## Electronics compartment

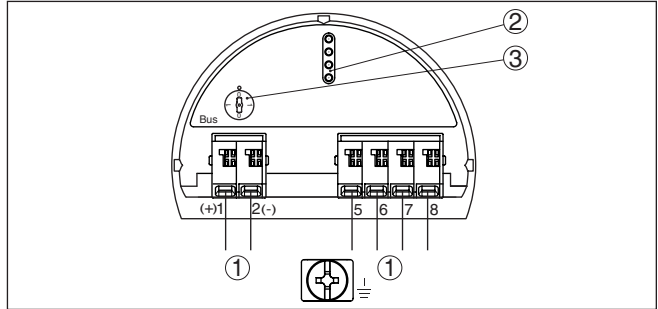

Fig. 12: Electronics compartment - double chamber housing

- 1 Internal connection to the connection compartment
- 2 Contact pins for the display and adjustment module or interface adapter
- 3 Simulation switch ("1" = mode for simulation release)

## Connection compartment

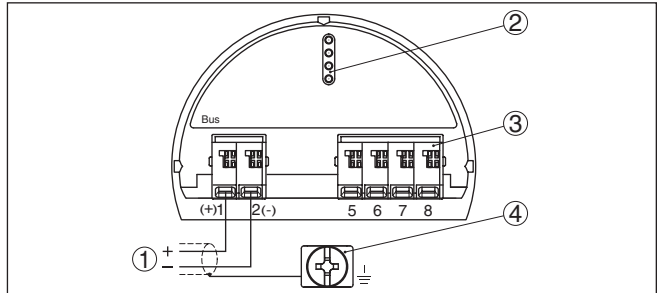

Fig. 13: Connection compartment - double chamber housing

- 1 Voltage supply, signal output
- 2 For display and adjustment module or interface adapter
- 3 For external display and adjustment unit
- 4 Ground terminal for connection of the cable screening

## 5.5 Double chamber housing with VEGADIS-Adapter

### Electronics compartment

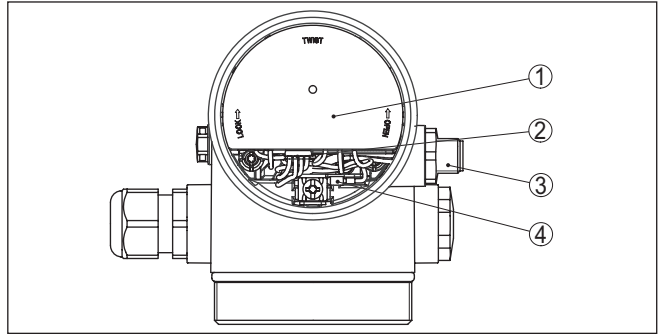

Fig. 14: View to the electronics compartment with VEGADIS adapter for connection of the external display and adjustment unit

- 1 VEGADIS adapter
- 2 Internal plug connection
- 3 M12 x 1 plug connector

### Assignment of the plug connector

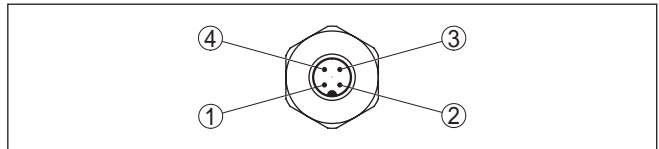

Fig. 15: Top view of the M12 x 1 plug connector

- 1 Pin 1
- 2 Pin 2
- 3 Pin 3
- 4 Pin 4

Contact pin	Colour, connection cable in the sensor	Terminal, electronics module
Pin 1	Brown	5
Pin 2	White	6
Pin 3	Blue	7
Pin 4	Black	8

**Wire assignment, connection cable****5.6 Wiring plan - version IP66/IP68 (1 bar)**

Fig. 16: Wire assignment in permanently connected connection cable

- 1 Brown (+) and blue (-) to power supply or to the processing system
- 2 Shielding

**5.7 Switch-on phase**

After connecting VEGAFLEX 83 to the bus system, the device first performs a self-test:

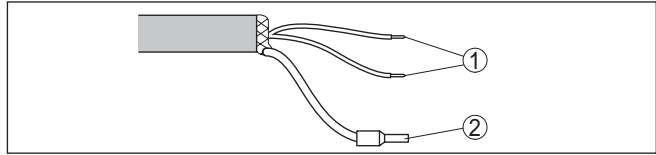
- Internal check of the electronics
- Indication of the status message " F 105 Determine measured value" on the display or PC
- Status byte goes to fault value

Then the actual measured value is output to the signal cable. The value takes into account settings that have already been carried out, e.g. default setting.



## 6 Set up with the display and adjustment module

### 6.1 Insert display and adjustment module

The display and adjustment module can be inserted into the sensor and removed again at any time. You can choose any one of four different positions - each displaced by 90°. It is not necessary to interrupt the power supply.

Proceed as follows:

1. Unscrew the housing lid
2. Place the display and adjustment module on the electronics in the desired position and turn it to the right until it snaps in.
3. Screw housing lid with inspection window tightly back on

Disassembly is carried out in reverse order.

The display and adjustment module is powered by the sensor, an additional connection is not necessary.



Fig. 17: Installing the display and adjustment module in the electronics compartment of the single chamber housing

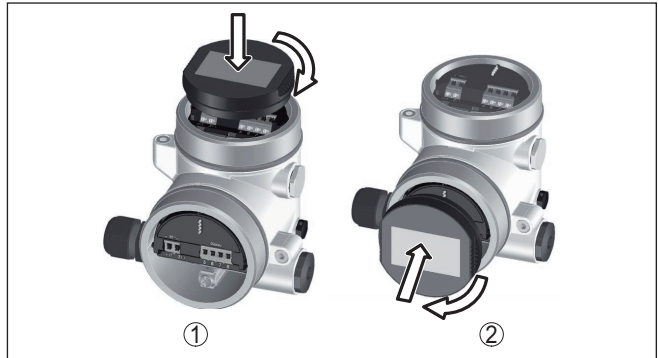

Fig. 18: Installing the display and adjustment module in the double chamber housing

- 1 In the electronics compartment
- 2 In the connection compartment



**Note:**

If you intend to retrofit the instrument with a display and adjustment module for continuous measured value indication, a higher lid with an inspection glass is required.

## 6.2 Adjustment system

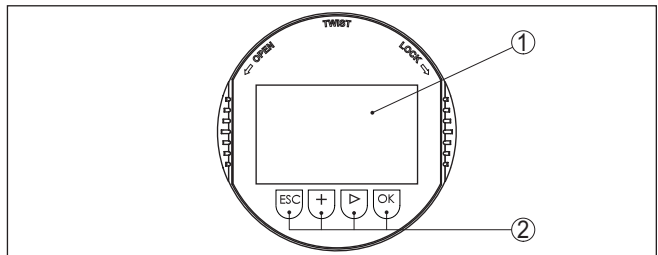

Fig. 19: Display and adjustment elements

- 1 LC display
- 2 Adjustment keys

### Key functions

- **[OK]** key:
  - Move to the menu overview
  - Confirm selected menu
  - Edit parameter
  - Save value
- **[->]** key:
  - Change measured value presentation
  - Select list entry
  - Select editing position
- **[+]** key:
  - Change value of the parameter

- **[ESC]** key:
  - Interrupt input
  - Jump to next higher menu

**Adjustment system**

The instrument is operated via the four keys of the display and adjustment module. The individual menu items are shown on the LC display. You can find the function of the individual keys in the previous illustration.

**Adjustment system - keys via magnetic pen**

With the Bluetooth version of the display and adjustment module you can also adjust the instrument with the magnetic pen. The pen operates the four keys of the display and adjustment module right through the closed lid (with inspection window) of the sensor housing.

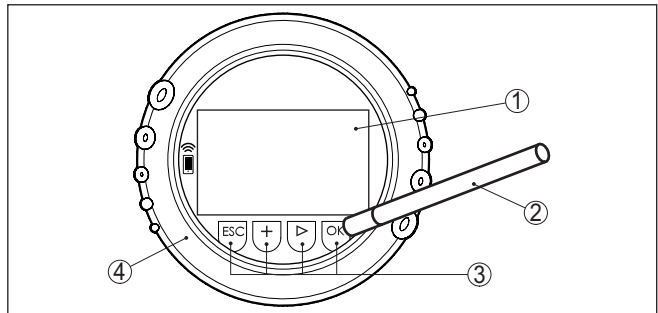

Fig. 20: Display and adjustment elements - with adjustment via magnetic pen

- 1 LC display
- 2 Magnetic pen
- 3 Adjustment keys
- 4 Lid with inspection window

**Time functions**

When the **[+]** and **[>]** keys are pressed quickly, the edited value, or the cursor, changes one value or position at a time. If the key is pressed longer than 1 s, the value or position changes continuously.

When the **[OK]** and **[ESC]** keys are pressed simultaneously for more than 5 s, the display returns to the main menu. The menu language is then switched over to "English".

Approx. 60 minutes after the last pressing of a key, an automatic reset to measured value indication is triggered. Any values not confirmed with **[OK]** will not be saved.

**Switch-on phase**

After switching on, the VEGAFLEX 83 carries out a short self-test where the device software is checked.

The output signal transmits a fault signal during the switch-on phase.

The following information is displayed on the display and adjustment module during the startup procedure:

- Instrument type
- Device name
- Software version (SW-Ver)
- Hardware version (HW-Ver)

**Measured value indication**

With the [->] key you move between three different indication modes:

In the first view, the selected measured value is displayed in large digits.

In the second view, the selected measured value and a respective bargraph presentation are displayed.

In the third view, the selected measured value as well as a second selectable value, e.g. the temperature, are displayed.

**Quick setup****6.3 Parameter adjustment - Quick setup**

To quickly and easily adapt the sensor to the application, select the menu item "Quick setup" in the start graphic on the display and adjustment module.



The following steps for the quick setup can be reached also in the "Extended adjustment".

- Instrument address
- Measurement loop name
- Medium type (optional)
- Application
- Max. adjustment
- Min. adjustment
- False signal suppression

You can find the description of the individual menu items in the following chapter "Parameter adjustment - Extended adjustment".

**6.4 Parameter adjustment - Extended adjustment**

For technically demanding measuring points, you can carry out extended settings in "Extended adjustment".

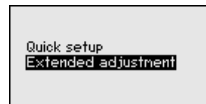
**Main menu**

The main menu is divided into five sections with the following functions:

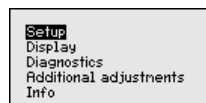

**Setup:** Settings, e.g. medium, application, vessel, adjustment, damping, device units, unit SV 2, false signal suppression, linearization

**Display:** Language setting, settings for the measured value indication as well as lighting

**Diagnosis:** Information, e.g. on instrument status, peak indicator, measurement reliability, simulation, echo curve

**Additional adjustments:** e.g. date/time, reset, copy sensor data

**Info:** Instrument name, hardware and software version, date of manufacture, device ID, instrument features



**Note:**

For optimum setting of the measuring point, the individual submenu items in the main menu item "Setup" should be selected one after the other and provided with the correct parameters. If possible, go through the items in the given sequence.

The procedure is described below.

The following submenu points are available:

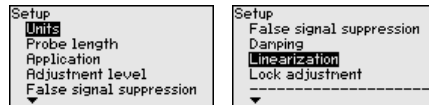

The submenu points are described below.

**6.4.1 Setup**

**Units**

In this menu item you select the distance unit and the temperature unit.

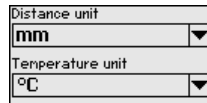

For the distance units you can choose between m, mm and ft and for the temperature units °C, °F and K.

**Probe length**

In this menu item you can enter the probe length or have the length determined automatically by the sensor system.

When choosing "Yes", then the probe length will be determined automatically. When choosing "No", you can enter the probe length manually.

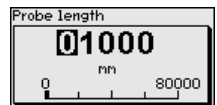
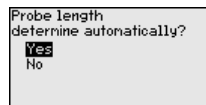
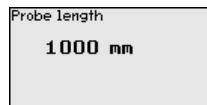

**Application - Medium type**

In this menu item you can select which type of medium you want to measure. You can choose between liquid or bulk solid.

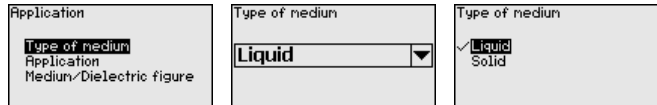

## Application

In this menu item, you can select the application. You can choose between level measurement and interface measurement. You can also choose between measurement in a vessel or in a bypass or standpipe.



### Note:

The selection of the application has a considerable influence on all other menu items. Keep in mind that as you continue with the parameter adjustment, individual menu items are only optionally available.

You have the option of choosing the demonstration mode. This mode is only suitable for test and demonstration purposes. In this mode, the sensor ignores the parameters of the application and reacts immediately to any change.

You have to enter the tube inner diameter when measuring in a bypass or standpipe.

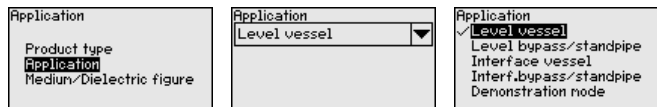

## Application - Medium, dielectric constant

In this menu item, you can define the type of medium (product).

This menu item is only available if you have selected level measurement under the menu item "Application".

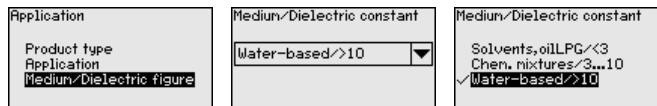

You can choose between the following medium types:

Dielectric constant	Type of medium	Examples
> 10	Water-based liquids	Acids, alcalis, water
3 ... 10	Chemical mixtures	Chlorobenzene, nitro lacquer, aniline, isocyanate, chloroform
< 3	Hydrocarbons	Solvents, oils, liquid gas

## Application - Gas phase

This menu item is only available, if you have chosen interface measurement under the menu item "Application". In this menu item you can enter if there is a superimposed gas phase in your application. Only set the function to "Yes", if the gas phase is permanently present.

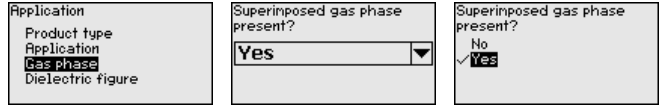

**Application - Dielectric constant**

This menu item is only available if you have selected interface measurement under the menu item " *Application*". In this menu item you can enter the dielectric constant of the upper medium.



You can directly enter the dielectric constant of the upper medium or have the value determined by the instrument. If you want the dielectric constant to be determined by the instrument, you have to enter the measured or known distance to the interface.



**Note:**

The dielectric constant can only be reliably determined if two different media and a sufficiently large interface are present.

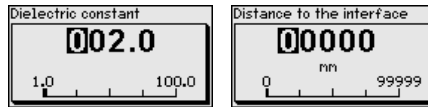

**Max. adjustment level**

In this menu item you can enter the max. adjustment for the level. With interface measurement this is the maximum total level.

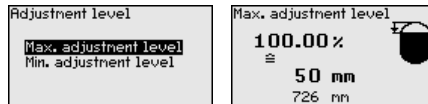

Adjust the requested percentage value with **[+]** and store with **[OK]**.

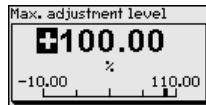

Enter the appropriate distance value in m (corresponding to the percentage value) for the full vessel. The distance refers to the sensor reference plane (seal surface of the process fitting). Keep in mind that the max. level must lie below the blocking distance.



**Min. adjustment level**

In this menu item you can enter the min. adjustment for the level. With interface measurement this is the minimum total level.

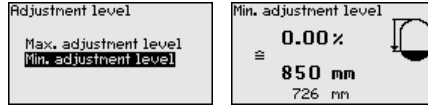

Adjust the requested percentage value with **[+]** and store with **[OK]**.

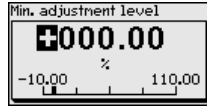

Enter the suitable distance value in m for the empty vessel (e.g. distance from the flange to the probe end) corresponding to the percentage value. The distance refers to the sensor reference plane (seal surface of the process fitting).

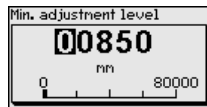

**Max. adjustment interface** This menu item is only available if you have selected interface measurement under the menu item "Application".

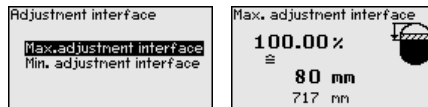

Enter the requested percentage value for the max. adjustment. As an alternative, you have the possibility taking over the adjustment of the level measurement also for the interface.

Enter the respective distance value in m for the surface of the upper medium corresponding to the percentage value.

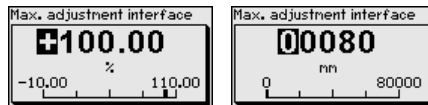

**Min. adjustment interface** This menu item is only available if you have selected interface measurement under the menu item "Application".

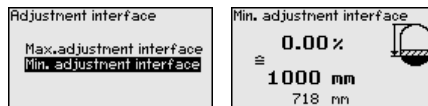

Enter the requested percentage value for the min. adjustment (interface).

Enter the respective distance value in m for the interface corresponding to the percentage value of the interface.

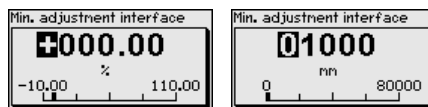



**False signal suppression** The following circumstances cause interfering reflections and can influence the measurement:

- High mounting nozzles
- Vessel internals such as struts



**Note:**

A false signal suppression detects, marks and saves these false signals so that they are no longer taken into account for the level and interface measurement. We generally recommend carrying out a false signal suppression to achieve the best possible accuracy. This should be done with the lowest possible level so that all potential interfering reflections can be detected.

Proceed as follows:

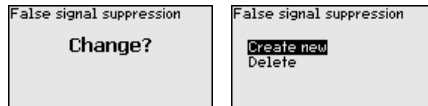

Select first if the probe is covered or uncovered.

If the probe is covered, enter the actual distance from the sensor to the product surface.

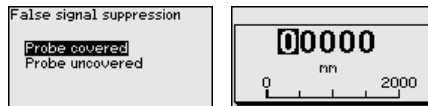

All interfering signals in this section are detected by the sensor and stored.

Keep in mind that with covered probe only false signals in the uncovered area of the probe are detected.



**Note:**

Check the distance to the medium surface, because if an incorrect (too large) value is entered, the existing level will be saved as a false signal. The level would then no longer be detectable in this area.

If a false signal suppression has already been saved in the sensor, the following menu window appears when selecting "False signal suppression":

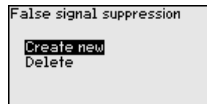

The instrument carries out an automatic false signal suppression as soon as the probe is uncovered. The false signal suppression is always updated.

The menu item "Delete" is used to completely delete an already created false signal suppression. This is useful if the saved false signal suppression no longer matches the metrological conditions in the vessel.

## Damping

To damp process-dependent measured value fluctuations, set an integration time of 0 ... 999 s in this menu item.

If you have selected interface measurement under the menu item "Application", you can adjust the damping for the level and the interface separately.

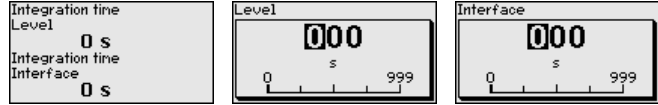

The default setting is a damping of 0 s.

## Linearisation

A linearisation is necessary for all vessels in which the vessel volume does not increase linearly with the level, e.g. a horizontal cylindrical or spherical tank, when the indication or output of the volume is required. Corresponding linearisation curves are preprogrammed for these vessels. They represent the correlation between the level percentage and vessel volume.

The linearisation applies to the measured value indication and the output. By activating the appropriate curve, the volume percentage of the vessel is displayed correctly. If the volume should not be displayed in percent but e.g. in l or kg, a scaling can be also set in the menu item "Display".

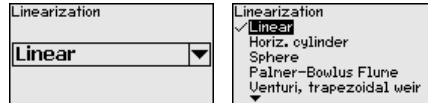

### Warning:

If a linearisation curve is selected, the measuring signal is no longer necessarily linear to the filling height. This must be considered by the user especially when setting the switching point on the limit signal transmitter.

In the following, you have to enter the values for your vessel, for example the vessel height and the socket correction.

For non-linear vessel forms, enter the vessel height and the socket correction.

For the vessel height, you have to enter the total height of the vessel.

For the nozzle correction you have to enter the height of the nozzle above the upper edge of the vessel. If the nozzle is lower than the upper edge of the vessel, this value can also be negative.

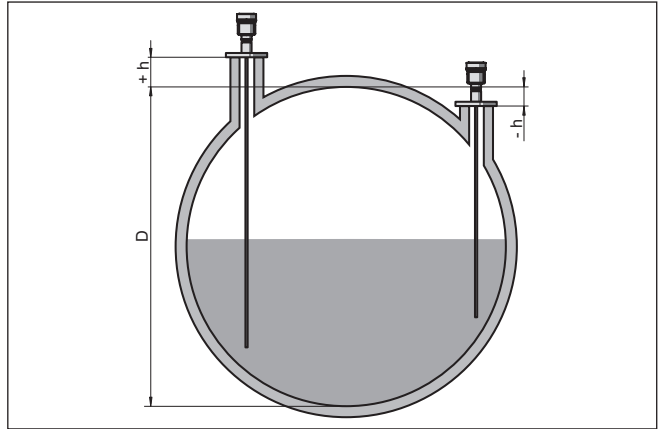
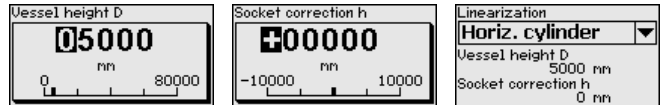

Fig. 21: Vessel height and socket correction value

D Vessel height

+h Positive socket correction value

-h Negative socket correction value



**Lock/Unlock adjustment**

In the menu item " *Lock/unlock adjustment*", you can protect the sensor parameters against unauthorized or inadvertent modification. The PIN is activated/deactivated permanently.

With active PIN, only the following adjustment functions are possible without entering a PIN:

- Select menu items and show data
- Read data from the sensor into the display and adjustment module

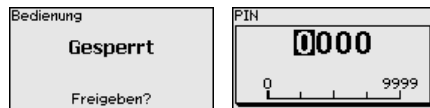

**Caution:**

When the PIN is active, adjustment via PACTware/DTM as well as other systems is also blocked.

In delivery status, the PIN is 0000.

Call our service department if you have modified and forgotten the PIN.

**6.4.2 Display**

In the main menu point " *Display*", the individual submenu points should be selected one after the other and provided with the correct parameters to ensure the optimum adjustment of the display. The procedure is described in the following.

The following submenu points are available:

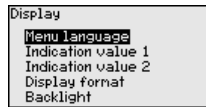

The submenu points are described below.

### Menu language

This menu item enables the setting of the requested national language.

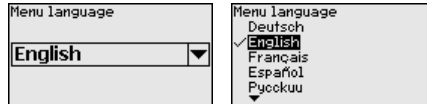

In delivery status, the sensor is set to English.

### Displayed value 1

In this menu item, you define the indication of the measured value on the display. You can display two different measured values. In this menu item, you define measured value 1.

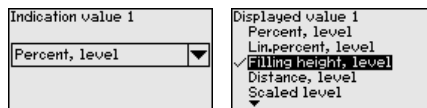

The default setting for the displayed value 1 is " *Filling height Level*".

### Displayed value 2

In this menu item, you define the indication of the measured value on the display. You can display two different measured values. In this menu item, you define measured value 2.

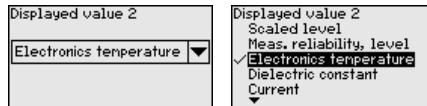

The default setting for the displayed value 2 is the electronics temperature.

### Display format

In this menu item, you define the display format of the measured value on the display. You can define different display formats for the two measured values.

You can thus define the number of decimal positions the measured value is displayed with.

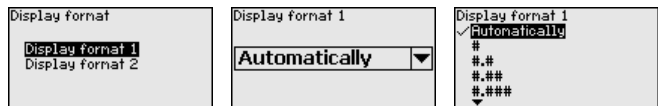

The default setting for the display format is " *Automatic*".

### Backlight

The integrated background lighting can be switched off via the adjustment menu. The function depends on the strength of the operating voltage, see " *Technical data*".

To maintain the function of the device, the lighting is temporarily switched off if the power supply is insufficient.



In delivery status, the lighting is switched on.

### 6.4.3 Diagnostics

#### Device status

In this menu item, the device status is displayed.

When the instrument displays a fault signal, you can here get detailed information on the failure reason.

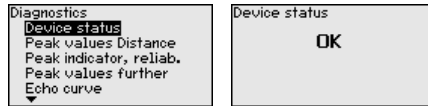

#### Peak indicator, distance

The respective min. and max. measured value is saved in the sensor. The two values are displayed in the menu item " *Peak indicator, distance*".

If you have selected interface measurement under the menu item " *Setup - Application*", the peak values of the interface measurement are displayed in addition to the peak values of the level measurement.

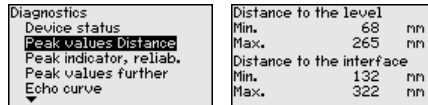

In another window you can carry out a reset of the two peak values separately.

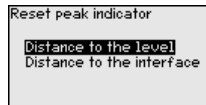

#### Peak indicator, measurement reliability

The respective min. and max. measured values are saved in the sensor. The two values are displayed in the menu item " *Peak indicator, measurement reliability*".

The measurement can be influenced by the process conditions. In this menu item, the measurement reliability of the level measurement is displayed in mV. The higher the value, the more reliable the measurement.

If you have selected interface measurement under the menu item " *Setup - Application*", the peak values of the interface measurement are displayed in addition to the peak values of the level measurement.

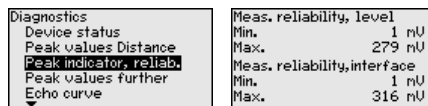

In another window you can carry out a reset of the two peak values separately.

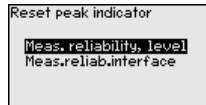

### Peak indicator, additional

The respective min. and max. measured values are saved in the sensor. The values are displayed in the menu item "*Peak indicator Additional*".

This menu item displays the peak values of the electronics temperature as well as the dielectric constant.

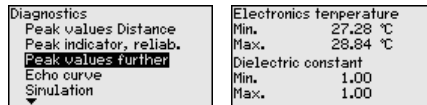

In another window you can carry out a reset of the two peak values separately.

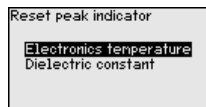

### Information:

If one of the display values flashes, there is actually no valid value available.

### Echo curve

The menu item "*Echo curve*" shows the signal strength of the echoes over the measuring range in V. The signal strength enables an evaluation of the quality of the measurement.

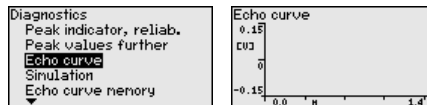

With the following functions you can zoom part sections of the echo curve.

- "X-Zoom": Zoom function for the meas. distance
- "Y-Zoom": 1, 2, 5 and 10x signal magnification in "V"
- "Unzoom": Reset the presentation to the nominal measuring range without magnification

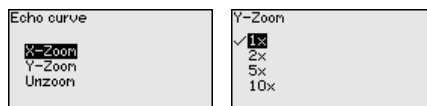

### Simulation

In this menu item you can simulate measured values via the current output. This allows the signal path to be tested, e.g. through downstream indicating instruments or the input card of the control system.

To activate the simulation, you have to set the simulation switch on the electronics module to 1.

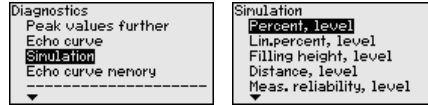

Select the requested simulation variable and set the requested value.

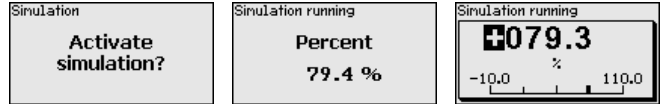

Push the [ESC] key to deactivate the simulation.



**Information:**

The simulation is terminated automatically 60 minutes after the activation of the simulation.

**Echo curve memory**

With the menu item "Setup" the echo curve it is possible to save at the time of setup. This is generally recommended; for using the Asset Management functions it is necessary. If possible, the curve should be saved with a low level in the vessel.

With this, you can detect signal changes over the operating time. With the adjustment software PACTware and the PC, the high-resolution echo curve can be displayed and used to compare the echo curve of the setup with the actual echo curve.



The function "Echo curve memory" enables storing echo curves of the measurement.

Under the sub-menu item "Echo curve memory" you can store the current echo curve.

Parameter settings for recording the echo curve and the settings of the echo curve itself can be carried out in the adjustment software PACTware.

With the adjustment software PACTware and the PC the high-resolution echo curve can be displayed and used later on to assess the quality of the measurement.

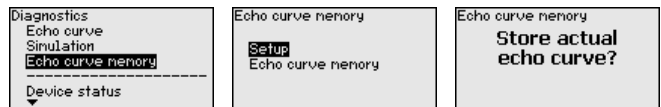

**6.4.4 Additional adjustments**

**Date/Time**

In this menu item, the internal clock of the sensor is set.

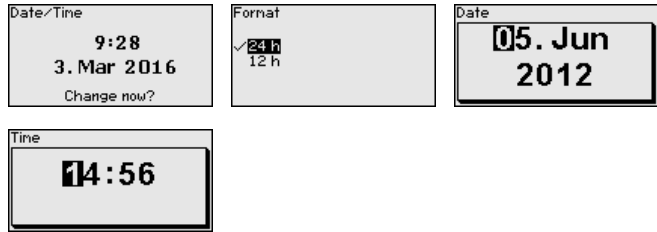

## Reset

After a reset, certain parameter adjustments made by the user are reset.



### Note:

After this menu window, the reset process is carried out. No further safety inquiry follows.



The following reset functions are available:

**Delivery status:** Restores the parameter settings at the time of shipment from the factory, incl. order-specific settings. Any stored false signal suppression or user-programmed linearisation curve, as well as the measured value memory, are deleted.

**Basic settings:** Resetting of the parameter settings incl. special parameters to the default values (presettings) of the respective instrument. Any created false signal suppression or user-programmable linearization curve as well as the measured value memory are deleted.

The following table shows the default values of the instrument. Depending on the instrument version or application, all menu items may not be available or some may be differently assigned:

## Menu - Setup

Menu item	Default value
Lock adjustment	Released
Measurement loop name	Sensor
Units	Distance unit: order-specific Temperature unit: order-specific
Probe length	Länge der Messsonde factory setting
Type of medium	Liquid
Application	Level in the vessel
Medium, dielectric constant	Water-based, > 10
Superimposed gas phase	Yes
Dielectric constant, upper medium (TS)	1.5
Tube inner diameter	200 mm



Menu item	Default value
Max. adjustment - Level	100 %
Max. adjustment - Level	Distance: 0.000 m(d) - note blocking distances
Min. adjustment - Level	0 %
Min. adjustment - Level	Distance: Probe length - take dead band into account
Accept adjustment of the level measurement?	No
Max. adjustment - Interface	100 %
Max. adjustment - Interface	Distance: 0.000 m(d) - note blocking distances
Min. adjustment - Interface	0 %
Min. adjustment - Interface	Distance: Probe length - take dead band into account
Integration time - Level	0.0 s
Integration time - Interface	0.0 s
Linearization type	Linear
Linearisation - Socket correction	0 mm
Linearisation - Vessel height	Probe length

### Menu - Display

Menu item	Default value
Language	Selected language
Displayed value 1	Filling height Level
Displayed value 2	Electronics temperature
Backlight	Switched on

### Menu - Diagnosis

Menu item	Default value
Status signals - Function control	Switched on
Status signals - Out of specification	Switched off
Status signals - Maintenance required	Switched off
Device memory - Echo curve memory	Stopped
Device memory - Measured value memory	Started
Device memory - Measured value memory - Measured values	Distance level, percentage value level, reliability level, electronics temperature
Device memory - Measured value memory - Recording in time interval	3 min.
Device memory - Measured value memory - Recording with measured value difference	15 %
Device memory - Measured value memory - Start with measured value	Not active

Menu item	Default value
Device memory - Measured value memory - Stop with measured value	Not active
Device memory - Measured value memory - Stop recording when memory is full	Not active

### Menu - Additional adjustments

Menu item	Default value
PIN	0000
Date	Actual date
Time	Actual time
Time - Format	24 hours
Probe type	Device-specific

**Copy instrument settings** The instrument settings are copied with this function. The following functions are available:

- **Read from sensor:** Read data from sensor and store into the display and adjustment module
- **Write into sensor:** Store data from the display and adjustment module back into the sensor

The following data or settings for adjustment of the display and adjustment module are saved:

- All data of the menu " *Setup*" and " *Display*"
- In the menu " *Additional adjustments*" the items " *Reset*, *Date/Time*"
- Special parameters

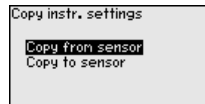
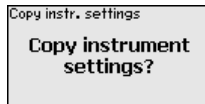

### Prerequisites

The following requirements must be met for a successful transmission:

- The data can only be transferred to the same device type, e.g. VEGAFLEX 83
- It must be the same probe type, e.g. rod probe
- The firmware of both devices is identical

The copied data are permanently saved in an EEPROM memory in the display and adjustment module and remain there even in case of power failure. From there, they can be written into one or more sensors or kept as backup for a possible electronics exchange.



### Note:

Before the data are stored in the sensor, a check is carried out to determine if the data fit the sensor. If the data do not fit, a fault signal

is triggered or the function is blocked. When data are being written into the sensor, the display shows which instrument type the data originate from and which TAG number this sensor had.



**Tip:**

We recommend to save the instrument adjustments. In case of an electronics exchange the saved parameter adjustment data relieve this process.

**Probe type**

In this menu item you can select the type and size of your probe from a list of all possible probes. This is necessary to adapt the electronics optimally to the probe.

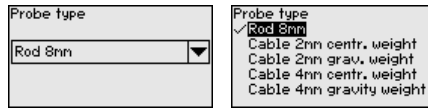

**Special parameters**

In this menu item you gain access to the protected area where you can enter special parameters. In exceptional cases, individual parameters can be modified in order to adapt the sensor to special requirements.

Change the settings of the special parameters only after having contacted our service staff.



**6.4.5 Info**

**Device name**

In this menu, you read out the instrument name and the instrument serial number.

**Instrument version**

In this menu item, the hardware and software version of the sensor is displayed.



**Factory calibration date**

In this menu item, the date of factory calibration of the sensor as well as the date of the last change of sensor parameters are displayed via the display and adjustment module or via the PC.

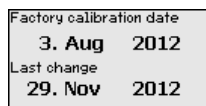

**Device ID**

In this menu item, the identification number of the instrument in a Foundation Fieldbus system is shown.

```

Device ID
0000620BF5
22222241
Sensor tag(PD_TAG)
FIELD DEVICE
22222241

```

**Sensor characteristics**

In this menu item, the features of the sensor such as approval, process fitting, seal, measuring range, electronics, housing and others are displayed.

Sensor characteristics  <b>Display now?</b>	Sensor characteristics Process fitting / Material  Thread G <sub>1</sub> PN6, DIN 3852-A / 316L	Sensor characteristics Cable entry / Conn ection  M20x1,5 / Cable gl and PA black
---	--	--

Example for displayed sensor features.

**6.5 Save parameter adjustment data****On paper**

We recommended writing down the adjustment data, e.g. in this operating instructions manual, and archiving them afterwards. They are thus available for multiple use or service purposes.

**In the display and adjustment module**

If the instrument is equipped with a display and adjustment module, the parameter adjustment data can be saved therein. The procedure is described in menu item "*Copy device settings*".

## 7 Set up with smartphone/tablet/PC/notebook via Bluetooth

### 7.1 Preparations

Make sure that the Bluetooth function of the display and adjustment module is activated. For this, the switch on the bottom side must be set to "On".

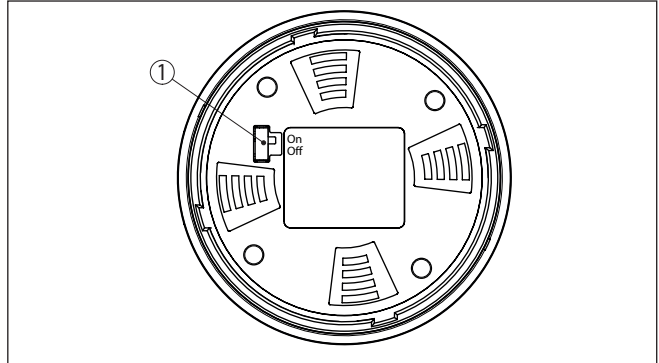

Fig. 22: Activate Bluetooth

- 1 Bluetooth switch
- On Bluetooth active
- Off Bluetooth not active

### Change sensor PIN

The security concept of Bluetooth operation absolutely requires that the default setting of the sensor PIN be changed. This prevents unauthorized access to the sensor.

The default setting of the sensor PIN is "0000". First of all you have to change the sensor PIN in the adjustment menu of the respective sensor, e.g. to "1111".



Use "OK" to switch to the input menu.

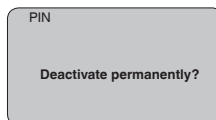
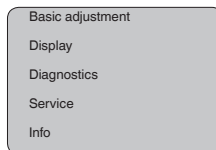

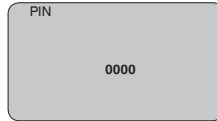

Change the PIN, e.g. to "1111".

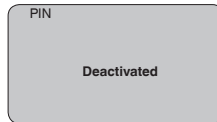
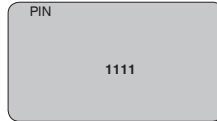

This permanently deactivates the PIN.

The display immediately changes to PIN activation.

Press "ESC" to cancel the activation of the PIN.

With "OK" you can enter and activate a PIN.

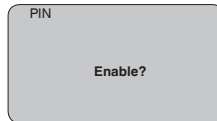

After the sensor PIN has been changed, sensor adjustment can be enabled again. For access (authentication) with Bluetooth, the modified PIN is still effective.



#### Information:

Bluetooth communication functions only if the actual sensor PIN differs from the default setting "0000".

## 7.2 Connecting

### Preparations

#### Smartphone/Tablet

Start the adjustment app and select the function "Setup". The smartphone/tablet searches automatically for Bluetooth-capable instruments in the area.

#### PC/Notebook

Start PACTware and the VEGA project assistant. Select the device search via Bluetooth and start the search function. The device automatically searches for Bluetooth-capable devices in the vicinity.

**Connecting**

The message " *Searching ...*" is displayed.

All found instruments will be listed in the adjustment window. The search is continued automatically.

Select the requested instrument in the device list.

The message " *Connecting ...*" is displayed.

**Authenticate**

For the first connection, the operating device and the sensor must authenticate each other. After successful authentication, the next connection functions without authentication.

For authentication, enter in the next menu window the 4-digit sensor PIN.

**7.3 Sensor parameter adjustment**

The sensor parameterization is carried out via the adjustment app on the smartphone/tablet or the DTM on the PC/notebook.

**App view**

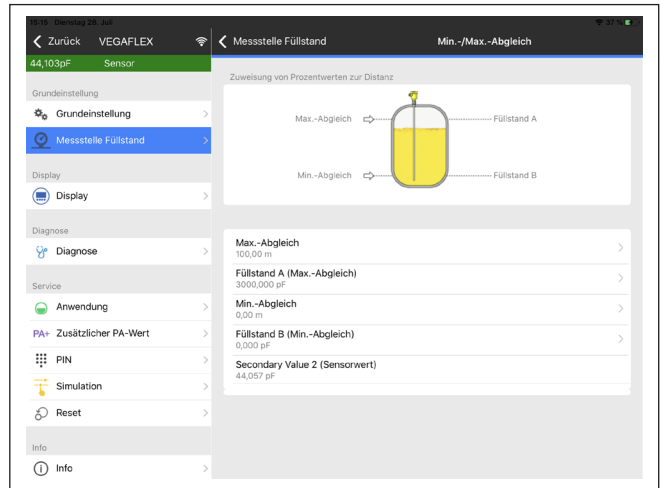

Fig. 23: Example of an app view - Setup sensor adjustment

## 8 Setup with PACTware

### 8.1 Connect the PC

Via the interface adapter directly on the sensor

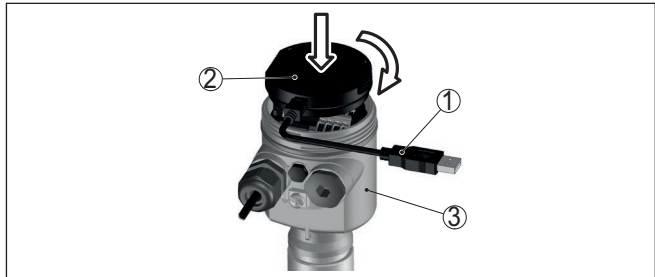

Fig. 24: Connection of the PC directly to the sensor via the interface adapter

- 1 USB cable to the PC
- 2 Interface adapter VEGACONNECT
- 3 Sensor

### 8.2 Parameter adjustment with PACTware

#### Prerequisites

For parameter adjustment of the sensor via a Windows PC, the configuration software PACTware and a suitable instrument driver (DTM) according to FDT standard are required. The up-to-date PACTware version as well as all available DTMs are compiled in a DTM Collection. The DTMs can also be integrated into other frame applications according to FDT standard.



#### Note:

To ensure that all instrument functions are supported, you should always use the latest DTM Collection. Furthermore, not all described functions are included in older firmware versions. You can download the latest instrument software from our homepage. A description of the update procedure is also available in the Internet.

Further setup steps are described in the operating instructions manual "DTM Collection/PACTware" attached to each DTM Collection and which can also be downloaded from the Internet. Detailed descriptions are available in the online help of PACTware and the DTMs.



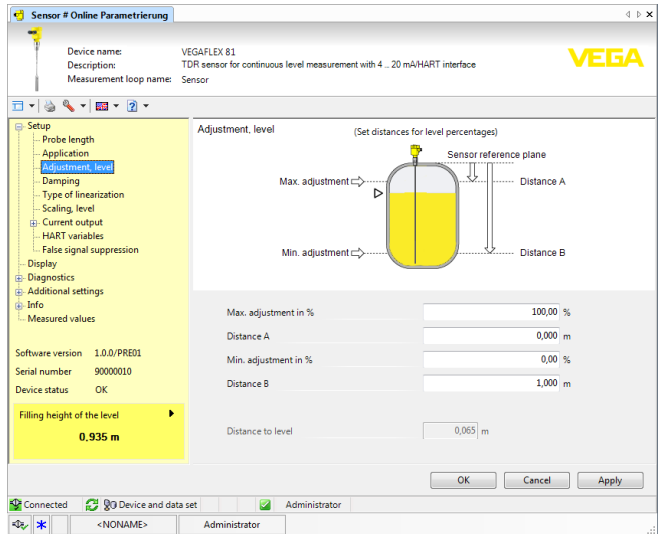

Fig. 25: Example of a DTM view

**Standard/Full version**

All device DTMs are available as a free-of-charge standard version and as a full version that must be purchased. In the standard version, all functions for complete setup are already included. An assistant for simple project configuration simplifies the adjustment considerably. Saving/printing the project as well as import/export functions are also part of the standard version.

In the full version there is also an extended print function for complete project documentation as well as a save function for measured value and echo curves. In addition, there is a tank calculation program as well as a multiviewer for display and analysis of the saved measured value and echo curves.

The standard version is available as a download under [www.vega.com/downloads](http://www.vega.com/downloads) and "Software". The full version is available on CD from the agency serving you.

**8.3 Set up with the quick setup**

**General information**

The quick setup is another option for parameter adjustment of the sensor. It allows fast, convenient adjustment of the most important parameters to adapt the sensor quickly to standard applications. To use it, select the function "Quick setup" in the start screen.

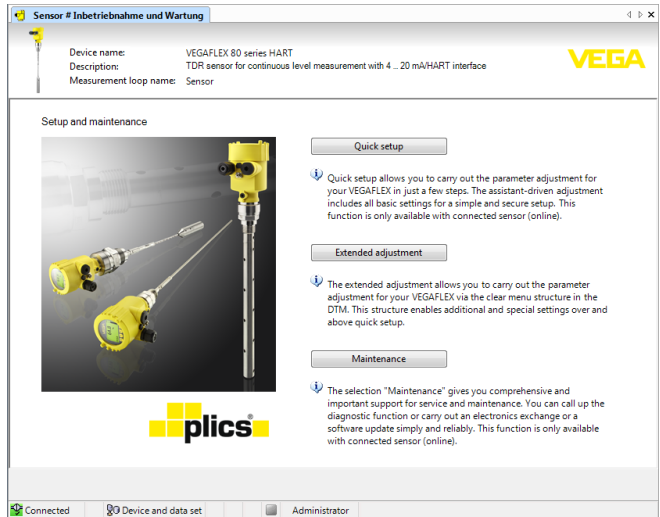

Fig. 26: Select quick setup

- 1 Quick setup
- 2 Extended adjustment
- 3 Maintenance

### Quick setup

With quick setup you can carry out the parameter adjustment of VEGAFLEX 83 for your application in just a few simple steps. The assistant-driven adjustment includes the basic settings for simple, reliable setup and commissioning.



#### Information:

If the function is inactive, then possibly no instrument is connected. Check the connection to the instrument.

### Extended adjustment

With the extended adjustment, you carry out the parameter adjustment for the instrument via the clear menu structure in the DTM (Device Type Manager). This enables additional and special settings over and above those offered by quick setup.

### Maintenance

Under the menu item "Maintenance" you get comprehensive and important support for servicing and maintenance. You can call up diagnostic functions and carry out an electronics exchange or a software update.

### Start quick setup

Click to the button "Quick setup", to start the assistant-driven adjustment for a simplified and reliable setup.

## 8.4 Save parameter adjustment data

We recommend documenting or saving the parameterisation data via PACTware. That way the data are available for multiple use or service purposes.

## 9 Set up with other systems

### 9.1 DD adjustment programs

Device descriptions as Enhanced Device Description (EDD) are available for DD adjustment programs such as, for example, AMS™ and PDM.

The files can be downloaded at [www.vega.com/downloads](http://www.vega.com/downloads) under "*Software*".

### 9.2 Field Communicator 375, 475

Device descriptions for the instrument are available as EDD for parameterisation with Field Communicator 375 or 475.

Integrating the EDD into the Field Communicator 375 or 475 requires the "Easy Upgrade Utility" software, which is available from the manufacturer. This software is updated via the Internet and new EDDs are automatically accepted into the device catalogue of this software after they are released by the manufacturer. They can then be transferred to a Field Communicator.

## 10 Diagnosis, asset management and service

### 10.1 Maintenance

#### Maintenance

If the device is used properly, no special maintenance is required in normal operation.

#### Cleaning

The cleaning helps that the type label and markings on the instrument are visible.

Take note of the following:

- Use only cleaning agents which do not corrode the housings, type label and seals
- Use only cleaning methods corresponding to the housing protection rating

### 10.2 Measured value and event memory

The instrument has several memories available for diagnostic purposes. The data remain there even in case of voltage interruption.

#### Measured value memory

Up to 100,000 measured values can be stored in the sensor in a ring memory. Each entry contains date/time as well as the respective measured value. Storable values are for example:

- Distance
- Filling height
- Percentage value
- Lin. percent
- Scaled
- Current value
- Measurement reliability
- Electronics temperature

When the instrument is shipped, the measured value memory is active and stores distance, measurement reliability and electronics temperature every 3 minutes.

In "Extended adjustment" you can select the respective measured values.

The requested values and recording conditions are set via a PC with PACTware/DTM or the control system with EDD. Data are thus read out and also reset.

#### Event memory

Up to 500 events are automatically stored with a time stamp in the sensor (non-deletable). Each entry contains date/time, event type, event description and value.

Event types are for example:

- Modification of a parameter
- Switch-on and switch-off times
- Status messages (according to NE 107)
- Error messages (according to NE 107)

The data are read out via a PC with PACTware/DTM or the control system with EDD.

## Echo curve memory

The echo curves are stored with date and time and the corresponding echo data. The memory is divided into two sections:

**Echo curve of the setup:** This is used as reference echo curve for the measurement conditions during setup. Changes in the measurement conditions during operation or buildup on the sensor can thus be recognized. The echo curve of the setup is stored via:

- PC with PACTware/DTM
- Control system with EDD
- Display and adjustment module

**Further echo curves:** Up to 10 echo curves can be stored in a ring buffer in this memory section. Additional echo curves are stored via:

- PC with PACTware/DTM
- Control system with EDD
- Display and adjustment module

## 10.3 Asset Management function

The instrument features self-monitoring and diagnostics according to NE 107 and VDI/VDE 2650. In addition to the status messages in the following tables there are more detailed error messages available under the menu item "Diagnostics" via the respective adjustment module.

## Status messages

The status messages are divided into the following categories:

- Failure
- Function check
- Out of specification
- Maintenance required

and explained by pictographs:

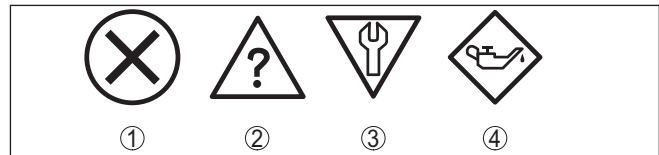

Fig. 27: Pictographs of the status messages

- 1 Failure - red
- 2 Out of specification - yellow
- 3 Function check - orange
- 4 Maintenance required - blue

### Malfunction (Failure):

Due to a malfunction in the instrument, a fault signal is output.

This status message is always active. It cannot be deactivated by the user.

### Function check:

The instrument is being worked on, the measured value is temporarily invalid (for example during simulation).

This status message is inactive by default.

**Out of specification:**

The measured value is unreliable because an instrument specification was exceeded (e.g. electronics temperature).

This status message is inactive by default.

**Maintenance required:**

Due to external influences, the instrument function is limited. The measurement is affected, but the measured value is still valid. Plan in maintenance for the instrument because a failure is expected in the near future (e.g. due to buildup).

This status message is inactive by default.

**Failure (failure)**

<b>Code Text message</b>	<b>Cause</b>	<b>Rectification</b>	<b>DevSpec Diagnosis Bits</b>
F013 no measured value available	Sensor does not detect an echo during operation Antenna system dirty or defective	Check for correct mounting and/or parameter adjustment Clean or exchange process component or antenna	Bit 0
F017 Adjustment span too small	Adjustment not within specification	Change adjustment according to the limit values (difference between min. and max. $\geq 10$ mm)	Bit 1
F025 Error in the linearization table	Index markers are not continuously rising, for example illogical value pairs	Check linearization table Delete table/Create new	Bit 2
F036 No operable software	Failed or interrupted software update	Repeat software update Check electronics version Exchanging the electronics Send instrument for repair	Bit 3
F040 Error in the electronics	Hardware defect	Exchanging the electronics Send instrument for repair	Bit 4
F041 Probe loss	Cable probe broken or rod probe defective	Check probe and exchange, if necessary	Bit 13
F080 General software error	General software error	Disconnect operating voltage briefly	Bit 5
F105 Measured value is determined	The instrument is still in the switch-on phase, the measured value could not yet be determined	Wait for the end of the switch-on phase Duration up to approx. 3 minutes depending on the version and parameter settings	Bit 6
F113 Communication error	Error in the internal instrument communication	Disconnect operating voltage briefly Send instrument for repair	-

Code Text message	Cause	Rectification	DevSpec Diagnosis Bits
F125 Impermissible electronics temperature	Temperature of the electronics in the non-specified range	Check ambient temperature Insulate electronics Use instrument with higher temperature range	Bit 7
F260 Error in the calibration	Error in the calibration carried out in the factory Error in the EEPROM	Exchanging the electronics Send instrument for repair	Bit 8
F261 Error in the instrument settings	Error during setup False signal suppression faulty Error when carrying out a reset	Repeat setup Repeat reset	Bit 9
F264 Installation/Set-up error	Adjustment not within the vessel height/measuring range Max. measuring range of the instrument not sufficient	Check for correct mounting and/or parameter adjustment Use an instrument with bigger measuring range	Bit 10
F265 Measurement function disturbed	Sensor no longer carries out a measurement Operating voltage too low	Check operating voltage Carry out a reset Disconnect operating voltage briefly	Bit 11
F266 Impermissible operating voltage	Wrong operating voltage	Check operating voltage Check connection cables	Bit 14
F267 No executable sensor software	Sensor cannot start	Exchanging the electronics Send instrument for repair	-

Tab. 8: Error codes and text messages, information on causes as well as corrective measures

### Function check

Code Text message	Cause	Rectification	TB Diagnostics
C700 Simulation active	A simulation is active	Finish simulation Wait for the automatic end after 60 mins.	Bit 27

Tab. 9: Error codes and text messages, information on causes as well as corrective measures

### Out of specification

Code Text message	Cause	Rectification	TB Diagnostics
S600 Impermissible electronics temperature	Temperature of the processing electronics in the non-specified section	Check ambient temperature Insulate electronics Use instrument with higher temperature range	Bit 23



<b>Code</b> <b>Text message</b>	<b>Cause</b>	<b>Rectification</b>	<b>TB</b> <b>Diagnostics</b>
S601 Overfilling	Level echo in the close range not available	Reduce level 100 % adjustment: Increase value Check mounting socket Remove possible interfering signals in the close range Use coaxial probe	Bit 24
S602 Level within the search range, compensation echo	Compensation echo superimposed by medium	100 % adjustment: Increase value	Bit 25
S603 Impermissible operating voltage	Operating voltage below specified range	Check electrical connection If necessary, increase operating voltage	Bit 26

Tab. 10: Error codes and text messages, information on causes as well as corrective measures

**Maintenance**

<b>Code</b> <b>Text message</b>	<b>Cause</b>	<b>Rectification</b>	<b>TB</b> <b>Diagnostics</b>
M500 Error in the delivery status	The data could not be restored during the reset to delivery status	Repeat reset Load XML file with sensor data into the sensor	Bit 15
M501 Error in the non-active linearisation table	Index markers are not continuously rising, for example illogical value pairs	Check linearization table Delete table/Create new	Bit 16
M504 Error at a device interface	Hardware defect	Exchanging the electronics Send instrument for repair	Bit 19
M505 no measured value available	Sensor does not detect an echo during operation	Check and correct mounting and/or parameter adjustment	Bit 20
	Process component or probe contaminated or defective	Clean or exchange process component or probe	Bit 20
M506 Installation/Set-up error	Error during setup	Check and correct mounting and/or parameter adjustment Check probe length	Bit 21
M507 Error in the instrument settings	Error during setup Error when carrying out a reset False signal suppression faulty	Carry out reset and repeat setup	Bit 22

Tab. 11: Error codes and text messages, information on causes as well as corrective measures

**10.4 Rectify faults**

**Reaction when malfunction occurs**

The operator of the system is responsible for taking suitable measures to rectify faults.

**Fault rectification**

The first measures are:

- Evaluation of fault messages
- Checking the output signal
- Treatment of measurement errors

A smartphone/tablet with the adjustment app or a PC/notebook with the software PACTware and the suitable DTM offer you further comprehensive diagnostic possibilities. In many cases, the causes can be determined in this way and the faults eliminated.

**Treatment of measurement errors**

The below tables show typical examples for application-relevant measurement errors. There are two measurement errors:

- Constant level
- Filling
- Emptying

The images in column "Error pattern" show the real level as a broken line and the level displayed by the sensor as a continuous line.

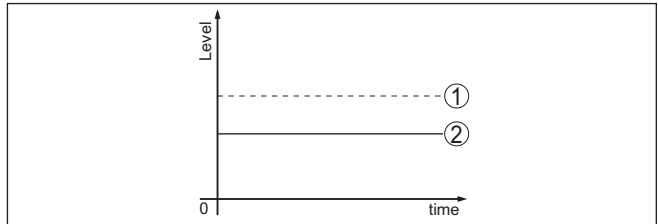

Fig. 28: The broken line 1 shows the real level, the continuous line 2 shows the level displayed by the sensor



**Note:**

If the output level is constant, the cause could also be the fault setting of the output to "Hold value".

If the level is too low, the reason could be a line resistance that is too high

**Measurement error with constant level**

Fault description	Cause	Rectification
Measured value shows a too low or too high level 	Min./max. adjustment not correct	Adapt min./max. adjustment
	Incorrect linearization curve	Adapt linearization curve
	Running time error (small measurement error close to 100 %/serious error close to 0 %)	Repeat setup

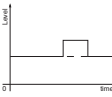
Fault description	Cause	Rectification
Measured value jumps towards 100 % 	Due to the process, the amplitude of the product echo decreases A false signal suppression was not carried out	Carry out a false signal suppression
	Amplitude or position of a false signal has changed (e.g. buildup); false signal suppression no longer matches	Determine the reason for the changed false signals, carry out false signal suppression, e.g. with buildup

**Measurement error during filling**

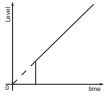
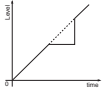
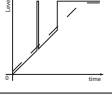
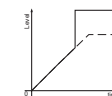
Fault description	Cause	Rectification
Measured value remains in the area of the bottom during filling 	Echo from the probe end larger than the product echo, for example, with products with $\epsilon_r < 2.5$ oil-based, solvents, etc.	Check parameter "Medium" and "Vessel height", adapt if necessary
Measured value remains momentarily unchanged during filling and then jumps to the correct level 	Turbulence on the medium surface, quick filling	Check parameters, change if necessary, e.g. in dosing vessel, reactor
Measured value jumps sporadically to 100 % during filling 	Changing condensation or contamination on the probe	Carry out a false signal suppression
Measured value jumps to $\geq 100\%$ or 0 m distance 	Level echo is no longer detected in the close range due to false signals in the close range. The sensor goes into overfill protection mode. The max. level (0 m distance) as well as the status message "Overfill protection" are output.	Eliminate false signals in the close range Check installation conditions If possible, switch off the function "Overfill protection"

**Measurement error during emptying**

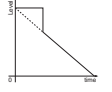
Fault description	Cause	Rectification
Measured value remains unchanged in the close range during emptying 	False signal larger than the level echo Level echo too small	Eliminate false signals in the close range Remove contamination on the probe. After having removed the source of the false signals, the false signal suppression must be deleted. Carry out a new false signal suppression

44227-EN-230605

Fault description	Cause	Rectification
Measured value remains reproducible in one position during emptying 	Stored false signals in this position are larger than the level echo	Delete false signal suppression Carry out a new false signal suppression

**Treatment of measurement errors with bulk solids**

The below tables show typical examples of application-related measurement errors with bulk solids. A distinction is made between measurement errors during:

- Constant level
- Filling
- Emptying

The images in column "Error pattern" show the real level as a broken line and the level displayed by the sensor as a continuous line.

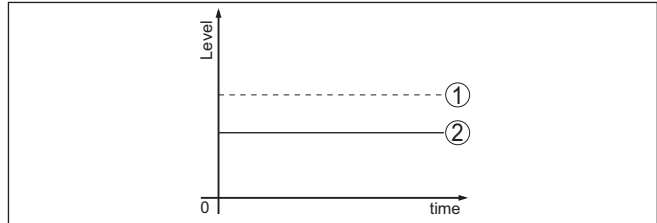

- 1 Real level
- 2 Level displayed by the sensor



**Note:**

If the output level is constant, the cause could also be the fault setting of the current output to "Hold value".

If the level is too low, the reason could be a line resistance that is too high

**Measurement error with constant level**

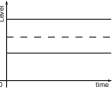

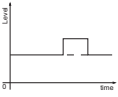
Fault description	Cause	Rectification
Measured value shows a too low or too high level 	Min./max. adjustment not correct	Adapt min./max. adjustment
	Incorrect linearization curve	Adapt linearization curve

Fault description	Cause	Rectification
Measured value jumps towards 100 % 	Due to the process, the amplitude of the product echo decreases  A false signal suppression was not carried out	Carry out a false signal suppression
	Amplitude or position of a false signal has changed (e.g. condensation, buildup); false signal suppression no longer matches actual conditions	Determine the reason for the changed false signals, carry out false signal suppression, e.g. with condensation

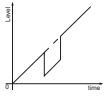
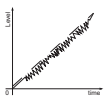
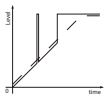
**Measurement error during filling**

Fault description	Cause	Rectification
Measured value jumps towards 0 % during filling 	Amplitude of a multiple echo (vessel top - medium surface) is larger than the level echo	Check parameter "Application", especially vessel top, type of medium, dished bottom, high dielectric constant, and adapt if necessary
	The level echo cannot be distinguished from the false signal at a false signal position (jumps to multiple echo)	In case of interferences due to installations in the close range: Change polarisation direction  Chose a more suitable installation position
	Transverse reflection from an extraction funnel, amplitude of the transverse reflection larger than the level echo	Direct sensor to the opposite funnel wall, avoid crossing with the filling stream
Measured value fluctuates around 10 ... 20 % 	Various echoes from an uneven medium surface, e.g. a material cone	Check parameter "Material Type" and adapt, if necessary  Optimize installation position and sensor orientation
	Reflections from the medium surface via the vessel wall (deflection)	Select a more suitable installation position, optimize sensor orientation, e.g. with a swivelling holder
Measured value jumps sporadically to 100 % during filling 	Varying condensation or contamination on the antenna	Carry out a false signal suppression or increase false signal suppression with condensation/contamination in the close range by editing  With bulk solids use radar sensor with purging air connection or flexible antenna cover

### Measurement error during emptying

Fault description	Cause	Rectification
Measured value remains unchanged in the close range during emptying 	False signal larger than the level echo Level echo too small	Eliminate false signals in the close range. Check: Antenna must protrude out of the nozzle Remove contamination on the antenna In case of interferences due to installations in the close range: Change polarisation direction After eliminating the false signals, the false signal suppression must be deleted. Carry out a new false signal suppression
Measured value jumps sporadically towards 100 % during emptying 	Varying condensation or contamination on the antenna	Carry out false signal suppression or increase false signal suppression in the close range by editing With bulk solids use radar sensor with purging air connection or flexible antenna cover
Measured value fluctuates around 10 ... 20 % 	Various echoes from an uneven medium surface, e.g. an extraction funnel Reflections from the medium surface via the vessel wall (deflection)	Check parameter "Material Type" and adapt, if necessary Optimize installation position and sensor orientation

#### Reaction after fault rectification

Depending on the reason for the fault and the measures taken, the steps described in chapter "Setup" must be carried out again or must be checked for plausibility and completeness.

#### 24 hour service hotline

Should these measures not be successful, please call in urgent cases the VEGA service hotline under the phone no. **+49 1805 858550**.

The hotline is also available outside normal working hours, seven days a week around the clock.

Since we offer this service worldwide, the support is provided in English. The service itself is free of charge, the only costs involved are the normal call charges.

### 10.5 Exchanging the electronics module

If the electronics module is defective, it can be replaced by the user.



In Ex applications, only instruments and electronics modules with appropriate Ex approval may be used.

If there is no electronics module available on site, the electronics module can be ordered through the agency serving you. The electronics modules are adapted to the respective sensor and differ in signal output or voltage supply.

The new electronics module must be loaded with the default settings of the sensor. These are the options:

- In the factory
- Or on site by the user

In both cases, the serial number of the sensor is needed. The serial numbers are stated on the type label of the instrument, on the inside of the housing as well as on the delivery note.

When loading on site, the order data must first be downloaded from the Internet (see operating instructions " *Electronics module*").

**Information:**

All application-specific settings must be entered again. That's why you have to carry out a fresh setup after exchanging the electronics.

If you saved the parameter settings during the first setup of the sensor, you can transfer them to the replacement electronics module. A fresh setup is then not necessary.

## 10.6 Software update

The following components are required to update the instrument software:

- Instrument
- Voltage supply
- Interface adapter VEGACONNECT
- PC with PACTware
- Current instrument software as file

You can find the current instrument software as well as detailed information on the procedure in the download area of our homepage: [www.vega.com](http://www.vega.com).

You can find information about the installation in the download file.

**Caution:**

Instruments with approvals can be bound to certain software versions. Therefore make sure that the approval is still effective after a software update is carried out.

You can find detailed information in the download area at [www.vega.com](http://www.vega.com).

## 10.7 How to proceed if a repair is necessary

You can find an instrument return form as well as detailed information about the procedure in the download area of our homepage. By doing this you help us carry out the repair quickly and without having to call back for needed information.

Proceed as follows in case of repair:

- Print and fill out one form per instrument
- Clean the instrument and pack it damage-proof
- Attach the completed form and, if need be, also a safety data sheet outside on the packaging

- Ask the agency serving you to get the address for the return shipment. You can find the agency on our homepage.



## 11 Dismount

### 11.1 Dismounting steps

To remove the device, carry out the steps in chapters " *Mounting*" and " *Connecting to power supply*" in reverse.



**Warning:**

When dismantling, pay attention to the process conditions in vessels or pipelines. There is a risk of injury, e.g. due to high pressures or temperatures as well as aggressive or toxic media. Avoid this by taking appropriate protective measures.

### 11.2 Disposal



Pass the instrument on to a specialised recycling company and do not use the municipal collecting points.

Remove any batteries in advance, if they can be removed from the device, and dispose of them separately.

If personal data is stored on the old device to be disposed of, delete it before disposal.

If you have no way to dispose of the old instrument properly, please contact us concerning return and disposal.

## 12 Supplement

### 12.1 Technical data

#### General data

316L corresponds to 1.4404 or 1.4435

#### Materials, wetted parts

- |  |                          |
|--|--------------------------|
| – Process fitting                      | PTFE-TFM 1600            |
| – Process seal                         | PTFE-TFM 1600            |
| – Rod: $\varnothing$ 10 mm (0.394 in)  | 316L, PFA coated         |
| – Cable: $\varnothing$ 4 mm (0.157 in) | 316 (1.4401), PFA coated |
| – Gravity weight                       | PFA coated               |

#### Materials, non-wetted parts

- |   |   |
|---|---|
| – Plastic housing                               | Plastic PBT (Polyester)   |
| – Aluminium die-cast housing                    | Aluminium die-casting AlSi10Mg, powder-coated (Basis: Polyester)                      |
| – Stainless steel housing (precision casting)   | 316L  |
| – Stainless steel housing (electropolished)     | 316L  |
| – Seal between housing and housing lid          | Silicone SI 850 R   |
| – Inspection window in housing cover (optional) | Plastic housing: Polycarbonate (UL746-C listed)<br>Metal housing: Glass <sup>1)</sup> |
| – Ground terminal                               | 316L  |
| – Cable gland                                   | PA, stainless steel, brass  |
| – Sealing, cable gland                          | NBR   |
| – Blind plug, cable gland                       | PA  |

#### Process fittings

- |               |                              |
|---------------|------------------------------|
| – Clamp       | from 2"                      |
| – Slotted nut | from DN 32 PN 40             |
| – Flanges     | DIN from DN 25, ASME from 2" |

#### Weight

- |   |  |
|---|--|
| – Instrument weight (depending on process fitting)              | approx. 0.8 ... 8 kg (0.176 ... 17.64 lbs) |
| – Rod: $\varnothing$ 10 mm (0.394 in), PFA coated               | approx. 330 g/m (3.55 oz/ft)               |
| – Cable: $\varnothing$ 4 mm (0.157 in), PFA coated              | approx. 41 g/m (0.44 oz/ft)                |
| – Gravity weight (long) for cable $\varnothing$ 4 mm (0.157 in) | 325 g (11.5 oz)                            |

#### Probe length L (from seal surface)

- |  |   |
|--|---|
| – Rod: $\varnothing$ 10 mm (0.394 in), PFA coated  | up to 4 m (13.12 ft)                    |
| – Trimming accuracy (rod)                          | $\pm$ (1 mm + 0.05 % of the rod length) |
| – Cable: $\varnothing$ 4 mm (0.157 in), PFA coated | up to 32 m (105 ft)                     |

<sup>1)</sup> Aluminium, stainless steel precision casting and Ex d housing

– Trimming accuracy (cable)  $\pm(2 \text{ mm} + 0.05 \% \text{ of the cable length})$

Lateral load with rod:  $\varnothing 10 \text{ mm}$  (0.394 in), 4 Nm (3 lbf ft)  
PFA coated

Max. tensile load with cable:  $\varnothing 4 \text{ mm}$  2 KN (450 lbf)  
(0.157 in), PFA coated

Torque for NPT cable glands and Conduit tubes

- Plastic housing max. 10 Nm (7.376 lbf ft)
- Aluminium/Stainless steel housing max. 50 Nm (36.88 lbf ft)

**Input variable**

Measured variable Level of liquids

Min. dielectric constant of the medium

- Dielectric constant cable probes  $\geq 1.6$
- Dielectric constant rod probes  $\geq 1.6$

**Output variable**

Output signal digital output signal, Foundation Fieldbus protocol

Transmission rate 31.25 Kbit/s

Damping (63 % of the input variable) 0 ... 999 s, adjustable

Channel Numbers

- Channel 1 Process value
- Channel 8 Electronics temperature

Current value

- Non-Ex and Ex ia instrument 12 mA,  $\pm 0.5 \text{ mA}$
- Ex d ia devices 16 mA,  $\pm 0.5 \text{ mA}$

Resolution, digital  $> 1 \text{ mm}$  (0.039 in)

**Measurement accuracy (according to DIN EN 60770-1)**

Process reference conditions according to DIN EN 61298-1

- Temperature  $+18 \dots +30 \text{ }^\circ\text{C}$  ( $+64 \dots +86 \text{ }^\circ\text{F}$ )
- Relative humidity 45 ... 75 %
- Air pressure  $+860 \dots +1060 \text{ mbar}/+86 \dots +106 \text{ kPa}$   
( $+12.5 \dots +15.4 \text{ psig}$ )

Mounting, reference conditions

- Min. distance to internal installations  $> 500 \text{ mm}$  (19.69 in)
- Vessel metallic,  $\varnothing 1 \text{ m}$  (3.281 ft), centric mounting, process fitting flush with the vessel ceiling
- Medium Water/Oil (dielectric constant  $\sim 2.0$ )<sup>2)</sup>
- Mounting Probe end does not touch the vessel bottom

Sensor parameter adjustment No gating out of false signals carried out

Typical deviation - Interface measurement  $\pm 5 \text{ mm}$  (0.197 in)

<sup>2)</sup> With interface measurement = 2.0

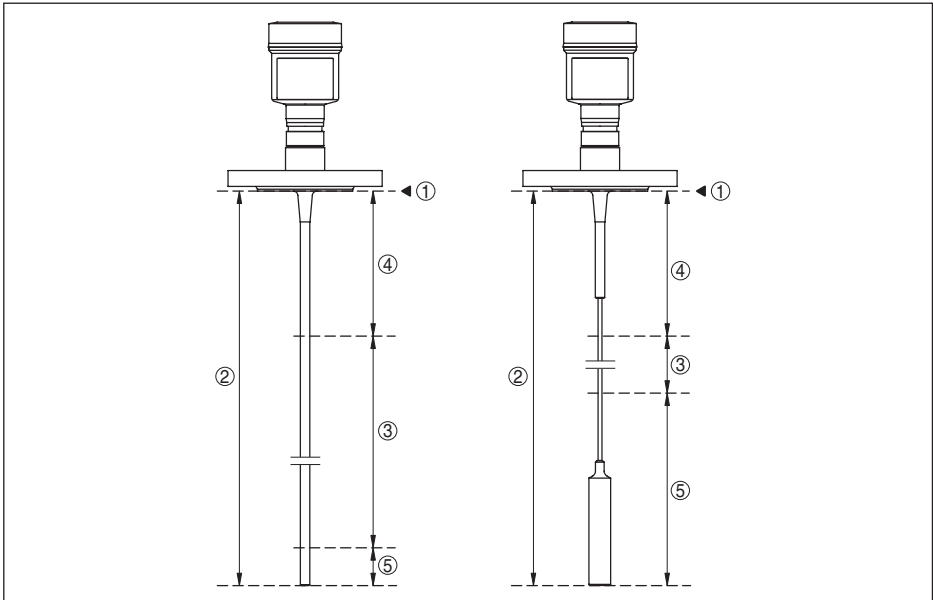

Fig. 29: Measuring ranges - VEGAFLEX 83

- 1 Reference plane
- 2 Probe length  $L$
- 3 Measuring range (default setting refers to the measuring range in water)
- 4 Upper blocking distance (see following diagrams - grey section)
- 5 Lower blocking distance (see following diagrams - grey section)

Typical deviation - Total level interface      See following diagrams  
measurement

Typical deviation - Level measurement <sup>3)4)</sup> See following diagrams

<sup>3)</sup> Depending on the mounting conditions, deviations can occur which can be rectified by adapting the adjustment or changing the measured value offset in the DTM service mode.

<sup>4)</sup> The blocking distances can be optimized via a false signal suppression.

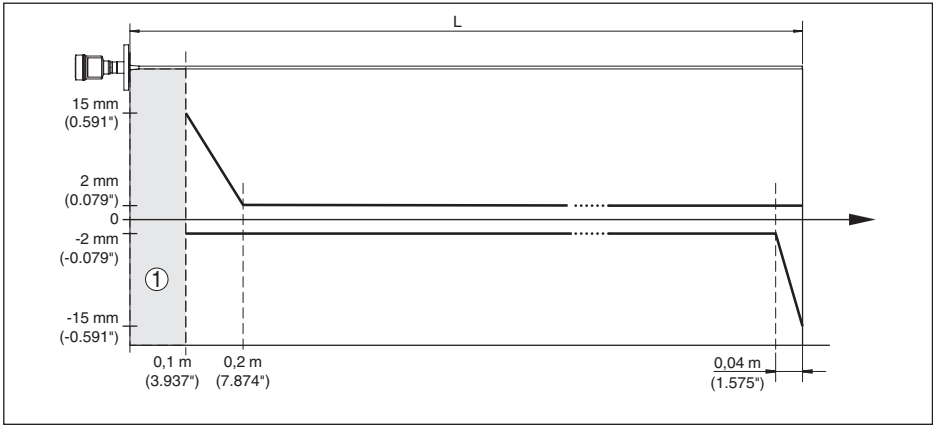

Fig. 30: Deviation VEGAFLEX 83 in rod version (coated) in water

- 1 Blocking distance (no measurement possible in this area)
- L Probe length

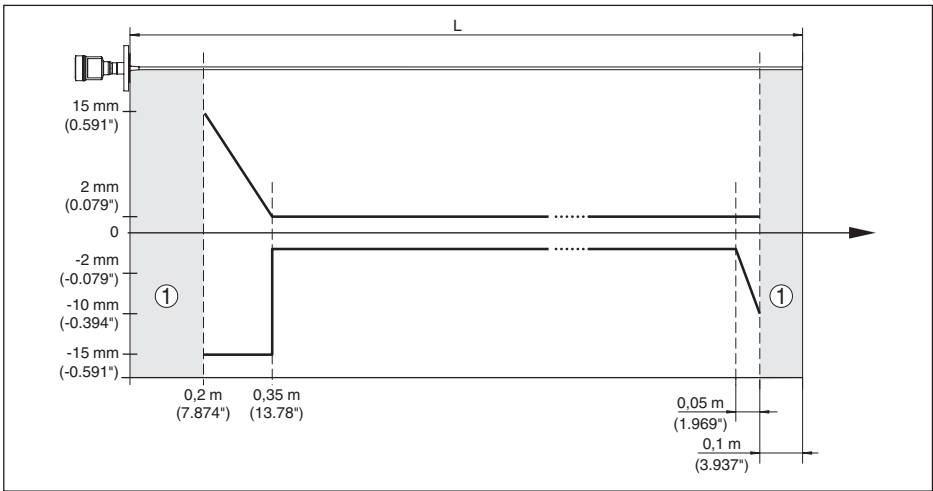

Fig. 31: Deviation VEGAFLEX 83 in rod version (coated) in oil

- 1 Blocking distance (no measurement possible in this area)
- L Probe length

Deviation (cable) from 6 m probe length = 0.5 % of the probe length

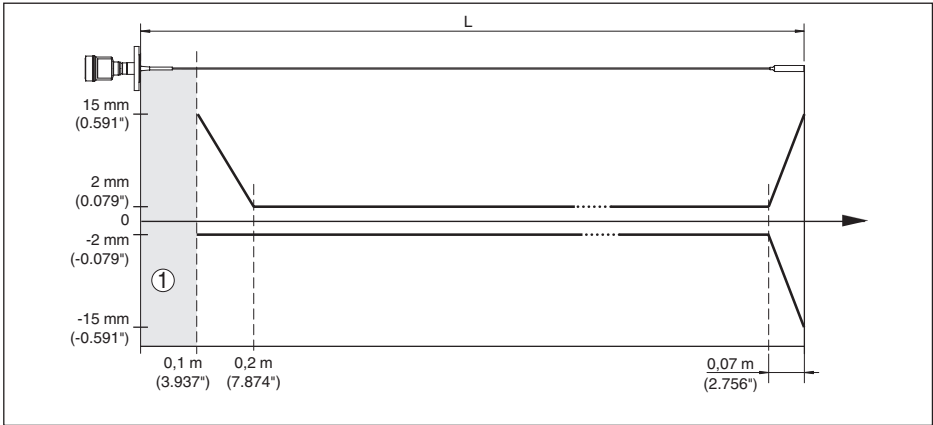

Fig. 32: Deviation VEGAFLEX 83 in cable version (coated) in water

- 1 Blocking distance (no measurement possible in this area)
- L Probe length

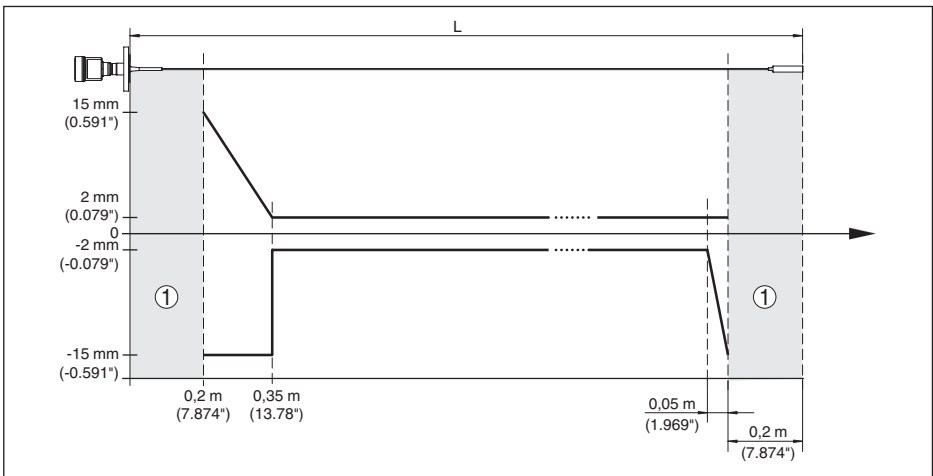

Fig. 33: Deviation VEGAFLEX 83 in cable version (coated) in oil

- 1 Blocking distance (no measurement possible in this area)
- L Probe length

Non-repeatability  $\leq \pm 1$  mm

**Variables influencing measurement accuracy**

Temperature drift - Digital output  $\pm 3$  mm/10 K relating to the max. measuring range or max. 10 mm (0.394 in)

Additional deviation through electromagnetic interference acc. to EN 61326  $< \pm 10$  mm ( $< \pm 0.394$  in)

**Influence of the superimposed gas and pressure on measurement accuracy**

The propagation speed of the radar impulses in gas or vapour above the medium is reduced by high pressure. This effect depends on the superimposed gas or vapours.

The following table shows the resulting deviation for some typical gases and vapours. The specified values refer to the distance. Positive values mean that the measured distance is too large, negative values that the measured distance is too small.

Gas phase	Temperature	Pressure		
		1 bar (14.5 psig)	10 bar (145 psig)	50 bar (725 psig)
Air	20 °C (68 °F)	0 %	0.22 %	1.2 %
	200 °C (392 °F)	-0.01 %	0.13 %	0.74 %
	400 °C (752 °F)	-0.02 %	0.08 %	0.52 %
Hydrogen	20 °C (68 °F)	-0.01 %	0.1 %	0.61 %
	200 °C (392 °F)	-0.02 %	0.05 %	0.37 %
	400 °C (752 °F)	-0.02 %	0.03 %	0.25 %
Steam (saturated steam)	100 °C (212 °F)	0.26 %	-	-
	180 °C (356 °F)	0.17 %	2.1 %	-
	264 °C (507 °F)	0.12 %	1.44 %	9.2 %
	366 °C (691 °F)	0.07 %	1.01 %	5.7 %

**Characteristics and performance data**

Measuring cycle time	< 500 ms
Step response time <sup>5)</sup>	≤ 3 s
Max. filling/emptying speed	1 m/min
	Products with high dielectric constant (> 10) up to 5 m/minute

**Ambient conditions**

Ambient, storage and transport temperature	
- Standard	-40 ... +80 °C (-40 ... +176 °F)
- CSA, Ordinary Location	-40 ... +60 °C (-40 ... +140 °F)

**Process conditions**

For the process conditions, please also note the specifications on the type label. The lowest value always applies.

The measurement error through the process conditions in the specified pressure and temperature range is < 1 %.

Process pressure	
- Clamp, flange version ≤ 2"/DN 50	-0.5 ... +16 bar/-50 ... +1600 kPa (-7.3 ... +232 psig), depending on the process fitting
- Clamp, flange version > 2"/DN 50	-0.2 ... +16 bar/-20 ... +1600 kPa (-2.9 ... +232 psig), depending on the process fitting

<sup>5)</sup> Time span after a sudden measuring distance change by max. 0.5 m in liquid applications, max 2 m with bulk solids applications, until the output signal has taken for the first time 90 % of the final value (IEC 61298-2).

Vessel pressure relating to the flange nominal pressure stage      see supplementary instructions manual "Flanges according to DIN-EN-ASME-JIS"  
 Process temperature (Clamp or flange temperature)

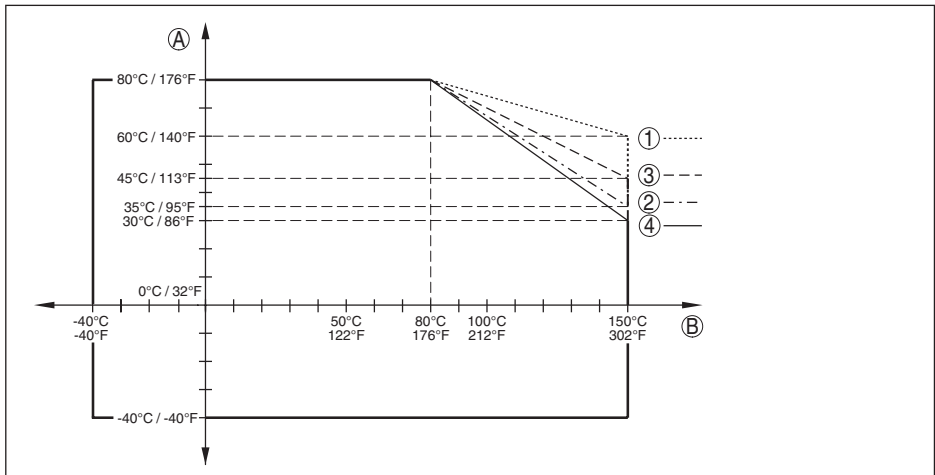

Fig. 34: Ambient temperature - process temperature, standard version

- A Ambient temperature
- B Process temperature (depending on the seal material)
- 1 Aluminium housing
- 2 Plastic housing
- 3 Stainless steel housing (precision casting)
- 4 Stainless steel housing (electropolished)

**Mechanical stress**

Vibration resistance

- Rod probe      1 g with 5 ... 200 Hz according EN 60068-2-6 (vibration at resonance) with rod length 50 cm (19.69 in)

Shock resistance

- Rod probe      25 g, 6 ms according to EN 60068-2-27 (mechanical shock) with rod length 50 cm (19.69 in)

**Electromechanical data - version IP66/IP67 and IP66/IP68 (0.2 bar)**

Options of the cable entry

- Cable entry      M20 x 1.5; ½ NPT
- Cable gland      M20 x 1.5; ½ NPT (cable ø see below table)
- Blind plug      M20 x 1.5; ½ NPT
- Closing cap      ½ NPT

Material cable gland	Material seal insert	Cable diameter				
		4.5 ... 8.5 mm	5 ... 9 mm	6 ... 12 mm	7 ... 12 mm	10 ... 14 mm
PA	NBR	-	●	●	-	●

44227-EN-230605



Material cable gland	Material seal insert	Cable diameter				
		4.5 ... 8.5 mm	5 ... 9 mm	6 ... 12 mm	7 ... 12 mm	10 ... 14 mm
Brass, nickel-plated	NBR	●	●	●	-	-
Stainless steel	NBR	-	●	●	-	●

Wire cross-section (spring-loaded terminals)

- Massive wire, stranded wire      0.2 ... 2.5 mm<sup>2</sup> (AWG 24 ... 14)
- Stranded wire with end sleeve      0.2 ... 1.5 mm<sup>2</sup> (AWG 24 ... 16)

### Electromechanical data - version IP66/IP68 (1 bar)

Options of the cable entry

- Cable gland with integrated connection cable      M20 x 1.5 (cable ø 5 ... 9 mm)
- Cable entry      ½ NPT
- Blind plug      M20 x 1.5; ½ NPT

Connection cable

- Wire cross-section      0.5 mm<sup>2</sup> (AWG 20)
- Wire resistance      < 0.036 Ω/m
- Tensile strength      < 1200 N (270 lbf)
- Standard length      5 m (16.4 ft)
- Max. length      180 m (590.6 ft)
- Min. bending radius (at 25 °C/77 °F)      25 mm (0.984 in)
- Diameter      approx. 8 mm (0.315 in)
- Colour - Non-Ex version      Black
- Colour - Ex-version      Blue

### Integrated clock

Date format	Day.Month.Year
Time format	12 h/24 h
Time zone, factory setting	CET
Max. rate deviation	10.5 min/year

### Additional output parameter - Electronics temperature

Range	-40 ... +85 °C (-40 ... +185 °F)
Resolution	< 0.1 K
Deviation	± 3 K
Availability of the temperature values	
- Indication	Via the display and adjustment module
- Output	Via the respective output signal

**Voltage supply**

Operating voltage $U_B$	9 ... 32 V DC
Operating voltage $U_B$ with lighting switched on	13.5 ... 32 V DC
Power supply by/max. number of sensors	
– Fieldbus	max. 32

**Potential connections and electrical separating measures in the instrument**

Electronics	Non-floating
Galvanic separation	
– between electronics and metallic parts of the device	Reference voltage 500 V AC
Conductive connection	Between ground terminal and metallic process fitting

**Electrical protective measures**

Housing material	Version	Protection acc. to IEC 60529	Protection acc. to NEMA
Plastic	Single chamber	IP66/IP67	Type 4X
	Double chamber	IP66/IP67	Type 4X
Aluminium	Single chamber	IP66/IP68 (0.2 bar)	Type 6P
		IP66/IP68 (1 bar)	Type 6P
	Double chamber	IP66/IP67 IP66/IP68 (0.2 bar) IP66/IP68 (1 bar)	Type 4X Type 6P Type 6P
Stainless steel (electro-polished)	Single chamber	IP66/IP68 (0.2 bar)	Type 6P
Stainless steel (precision casting)	Single chamber	IP66/IP68 (0.2 bar)	Type 6P
		IP66/IP68 (1 bar)	Type 6P
	Double chamber	IP66/IP67 IP66/IP68 (0.2 bar)	Type 4X Type 6P

Connection of the feeding power supply unit Networks of overvoltage category III

Altitude above sea level

- by default up to 2000 m (6562 ft)
- with connected overvoltage protection up to 5000 m (16404 ft)

Pollution degree (with fulfilled housing protection) 4

Protection rating (IEC 61010-1) III

**12.2 Device communication Foundation Fieldbus**

In the following, the necessary device-specific details are shown. You can find further information of Foundation Fieldbus on [www.fieldbus.com](http://www.fieldbus.com).

**Overview**

The following table gives you an overview of the instrument versions and the corresponding device descriptions, the electrical characteristics of the bus system as well as the applied function blocks.

Revisions Data	DD-Revision	Rev_01
	CFF-File	030101.cff
	Device Revision	3
	Cff-Revision	xx xx 01
	Device software revision	> 1.3.0
	ITK (Interoperability Test Kit) Number	6.2.0
Electrical Characteristics	Physical Layer Type	Low-power signaling, bus-powered, FISCO I.S.
	Input Impedance	> 3000 Ohms between 7.8 KHz - 39 KHz
	Unbalanced Capacitance	< 250 pF to ground from either input terminal
	Output Amplitude	0.8 V P-P
	Electrical Connection	2 Wire
	Polarity Insensitive	Yes
	Max. Current Load	10 mA
	Device minimum operating voltage	9 V
Transmitter Function Blocks	Resource Block (RB)	1
	Transducer Block (TB)	1
	Standard Block (AI)	3
	Execution Time	30 mS
Advanced Function Blocks	Discret Input (DI)	Yes
	PID Control	Yes
	Output Splitter (OS)	Yes
	Signal Characterizer (SC)	Yes
	Integrator	Yes
	Input Selector (IS)	Yes
	Arithmetic (AR)	Yes
Diagnostics	Standard	Yes
	Advanced	Yes
	Performance	No
	Function Blocks Instantiable	No
General Information	LAS (Link Active Scheduler)	Yes
	Master Capable	Yes
	Number of VCRs (Virtual Communication Relationships)	24

## Parameter list

The following table gives you an overview of the parameters used.

FF descriptor	Description	Unit
PRIMARY_VALUE	PRIMARY_VALUE (Linearized value). This is the process value after min/max adjustment and Linearization with the status of the transducer block. The unit is defined in "PRIMARY_VALUE_UNIT"	
PRIMARY_VALUE_UNIT	Selected unit code for "PRIMARY_VALUE"	
SECONDARY_VALUE_1	This is the measured value after min/max adjustment with the status of the transducer block. The unit is defined in "SECONDARY_VALUE_1_UNIT"	
SECONDARY_VALUE_1_UNIT	Selected unit code for "SECONDARY_VALUE_1"	
SECONDARY_VALUE_2	This is the distance value ("sensor_value") with the status of the transducer block. The unit is defined in "SECONDARY_VALUE_2_UNIT"	
FILL_HEIGHT_VALUE	Filling height. The unit is defined in "FILL_HEIGHT_VALUE_UNIT"	
FILL_HEIGHT_VALUE_UNIT	Filling height unit	
CONST_VALUE	Constant value	
SECONDARY_VALUE_1_TYPE	Secondary value 1 type	
SECONDARY_VALUE_2_TYPE	Secondary value 2 type	
FILL_HEIGHT_VALUE_Type	Filling height value type	
DIAGNOSIS	AITB Diagnosis	
DIAG_MASK_1		
DIAG_OUT_1		
DIAG_MASK_2		
DIAG_OUT_2		
DEVICE_IDENTIFICATION	Manufacturer ID, device type, bus type ID, measurement principle, serial number, DTM ID, device revision	
DEVICE_NAME	Device name	
IS-SPARE_ELECTRONICS	Device name	
DEVICE_VERSION_INFO	Hard- and software version for system, function and error	
CALIBRATION_DATE	Day, month and year	
FIRMWARE_VERSION_ASCII	Software version	
HW_VERSION_ASCII	Hardware version	
ADJUSTMENT_DATA	Min./max.-adjustment physical, percent and offset	
FIRMWARE_VERSION_MAIN	Software versions major, minor, revision and build	
PHYSICAL_VALUES	Distance, distance unit, distance status, level and status	
DEVICE_UNITS	Distance and temperature units of the instrument	

FF descriptor	Description	Unit
APPLICATION_CONFIG	Medium type, media, application type, vessel bottom, vessel height	
LINEARIZATION_TYPE_SEL	Type of linearization	
SIMULATION_PHYSICAL		
INTEGRATION_DATA	Physical offset and integration time	
DEVICE_CONFIG_PULS_RADAR	Electronics variant, probe type, max. measuring range, antenna extension length, adjustment propagation antenna extension Iprapproval configuration	
ADJUSTMENT_LIMITS_MIN	Min. range min./max.- values physical, percent, offset	
ADJUSTMENT_LIMITS_MAX	Max. range min./max.- values physical, percent, offset	%
FALSE_SIGNAL_COMMAND		%
FALSE_SIGNAL_CMD_CREATE_EXTEND		
FALSE_SIGNAL_CMD_DELETE_REGION		
FALSE_SIGNAL_CMD_STATE	Busy, last command, errorcode	
FALSE_SIGNAL_CMD_CONFIGURATION1	Amplitude safety of the 0 % curve, safety of the false signal suppression, position of the 0 % and 100 % curve in near and far range	
FALSE_SIGNAL_CMD_CONFIGURATION2	Gradient of the manual sectors, safety at the end of false echo memory and depending on the import range gating out the false signals	
ECP_CURVE_AVARAGING_CONFIG	Averaging factor on increasing and decreasing amplitude	
LEVEL_ECHO_MEASUREMENT	Function measured value filter	
ECHO_CURVE_STATUS		
PACKET_COUNT		
GU_ID_END		
ECHO_CURVE_READ	Echo curve data	
ECHO_EVALUATOR	Echo parameters, first large echo, amplitude threshold first large echo	
ECHO_DECIDER	Echo selection criteria, fault signal on loss of echo, delay on fault signal on loss of echo	
DISPLAY_SETTINGS	Indication value, menu language, lightning	
SIL_MODE		
EDENVELOPE_CURVE_FILTER	Parameters of envelope curve filter, activation of smooth raw value curve	
EDDETECTION_CURVE_FILTER	Parameters of the detection filter, offset threshold value curve	
EDECHO_COMBINATION	Parameters for echo combination, function combine echoes, amplitude difference of combined echoes, position difference of combined echoes	

44227-EN-230605

FF descriptor	Description	Unit
LIN_TABLE_A ... LIN_TABLE_Q	32 couples of percentage and lin. percentage values	
ELECTRONICS_INFORMATION	Electronics version	
APPLICATION_CONFIG_SERVICE	Limitation measuring range begin, safety of measuring range end	
LEVEL_ECHO_INFO	Level echo ID, amplitude, measurement safety	
DEVICE_STATUS	Device status	
FALSE_SIGNAL_LIMITS	False signal distance min./max.	
USER_PEAK_ELEC_TEMP	Min./max. - values of electronics temperature, date	
USER_MIN_MAX_PHYSICAL_VALUE	Min./max. - distance values, date	
RESET_PEAK_PHYSICAL_VALUE		
RESET_LINEARIZATION_CURVE		
DEVICE_STATUS_ASCII	Device status	
ECHO_CURVE_PLICSCOM_REQUEST	Parameters as curve selection and resolution	
ECHO_CURVE_PLICSCOM_LIMITS	Parameters as start and end	
APPROVAL_WHG	Sensor acc. to WHG	
DEVICE_STATE_CONFIG	Function check, maintenance required, out of specification	
ELECTRONIC_TEMPERATURE	Electronics temperature	
RESET_PEAK_ELECTRONIC_TEMP		
FOCUS_RANGE_CONFIG	Width focusing range, time for opening the focusing range, min. measurement reliability in and outside the focusing range	
NOISE_DETECTION_INFO	Increase of the system noise	
NOISE_DETECTION_CONFIG	System noise treatment	
ECHO_MEM_SAVE_CURVE_TYPE		
ECHO_MEM_STATE	Busy, curve type, error code	

### 12.3 Dimensions

The following dimensional drawings represent only an extract of all possible versions. Detailed dimensional drawings can be downloaded at [www.vega.com/downloads](http://www.vega.com/downloads) under "Drawings".

**Plastic housing**

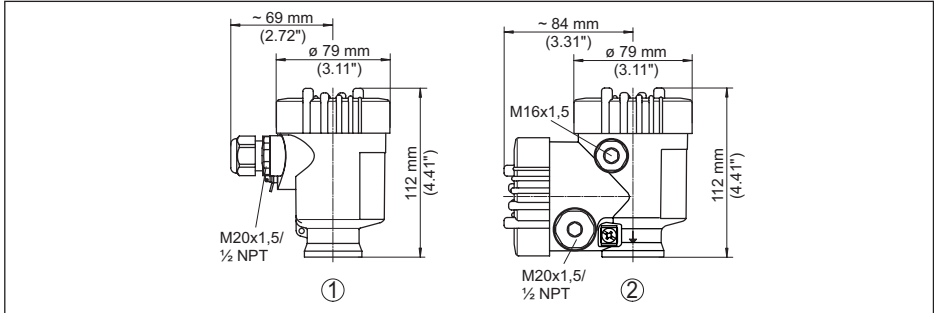

Fig. 35: Housing versions in protection IP66/IP67 (with integrated display and adjustment module the housing is 9 mm/0.35 in higher)

- 1 Plastic single chamber
- 2 Plastic double chamber

**Aluminium housing**

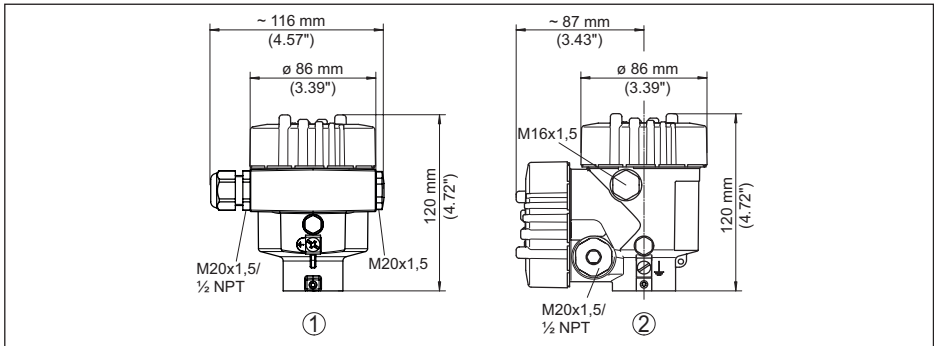

Fig. 36: Housing versions with protection rating IP66/IP68 (0.2 bar), (with integrated display and adjustment module the housing is 9 mm/0.35 in higher)

- 1 Aluminium - single chamber
- 2 Aluminium - double chamber

### Aluminium housing with protection rating IP66/IP68 (1 bar)

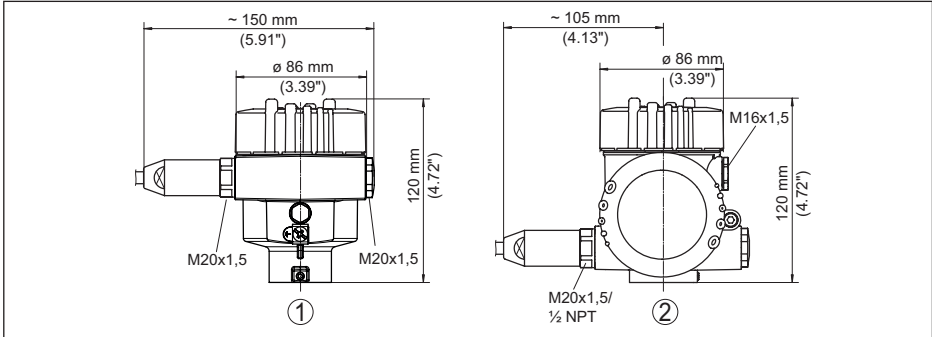

Fig. 37: Housing versions in protection IP66/IP68 (1 bar), (with integrated display and adjustment module the housing is 9 mm/0.35 in higher)

- 1 Aluminium - single chamber
- 2 Aluminium - double chamber

### Stainless steel housing

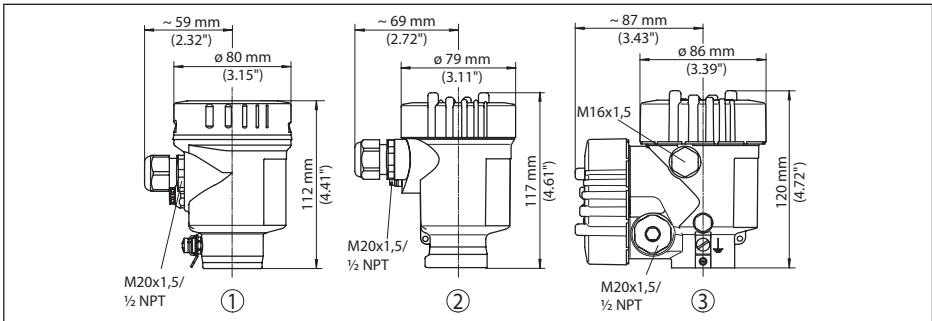
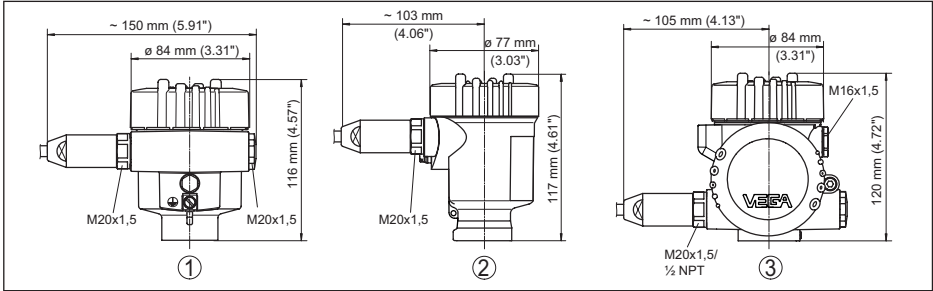

Fig. 38: Housing versions with protection rating IP66/IP68 (0.2 bar), (with integrated display and adjustment module the housing is 9 mm/0.35 in higher)

- 1 Stainless steel single chamber (electropolished)
- 2 Stainless steel single chamber (precision casting)
- 3 Stainless steel double chamber housing (precision casting)



**Stainless steel housing with protection rating IP66/IP68 (1 bar)**



*Fig. 39: Housing versions in protection IP66/IP68 (1 bar), (with integrated display and adjustment module the housing is 9 mm/0.35 in higher)*

- 1 *Stainless steel single chamber (electropolished)*
- 2 *Stainless steel single chamber (precision casting)*
- 3 *Stainless steel double chamber housing (precision casting)*

**VEGAFLEX 83, cable version  $\varnothing$  4 mm (0.157 in), PFA coated**

Fig. 40: VEGAFLEX 83, cable version with gravity weight

- L Sensor length, see chapter "Technical data"
- 1 Cable version,  $\varnothing$  4 mm (0.157 in) with flange
- 2 Cable version with Clamp
- 3 Cable version with slotted nut

**VEGAFLEX 83, rod version  $\varnothing$  10 mm (0.394 in), PFA coated**

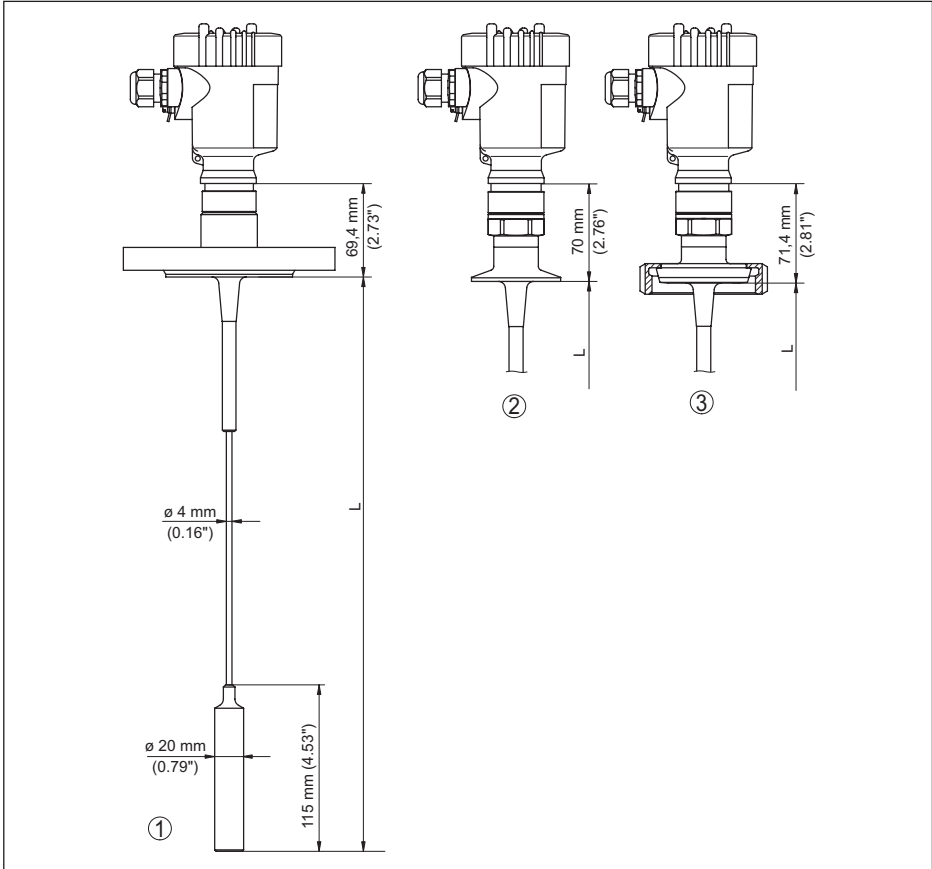
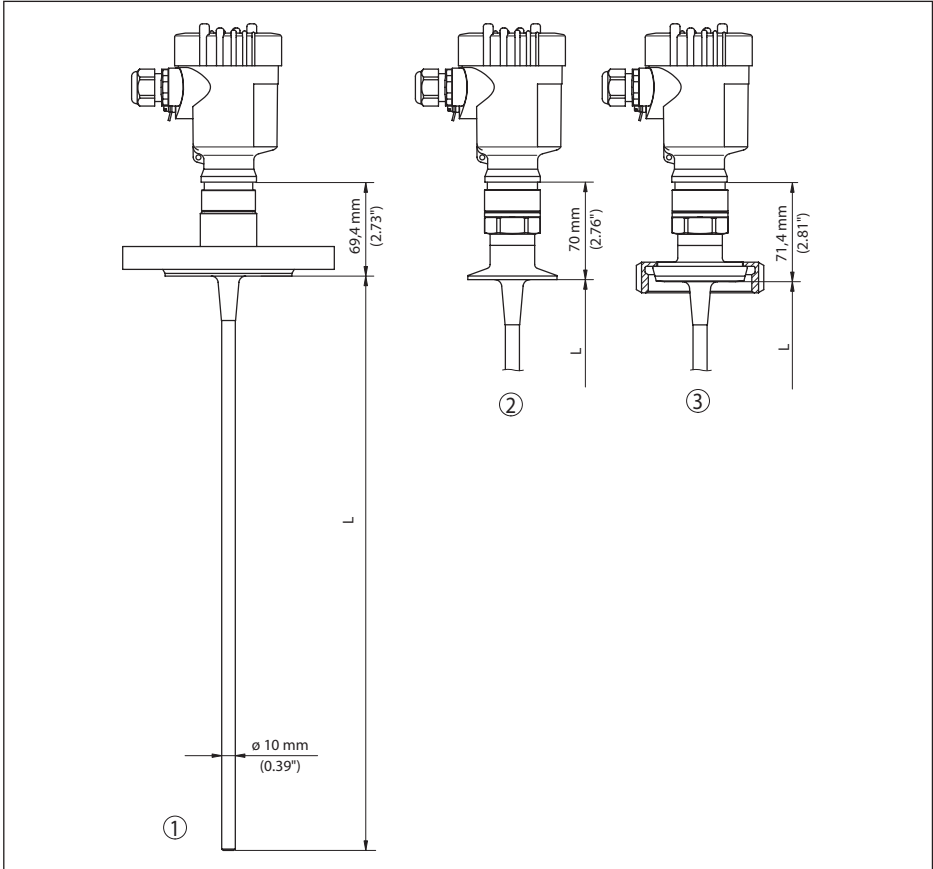

Fig. 41: VEGAFLEX 83, rod version

*L* Sensor length, see chapter "Technical data"

1 Rod version,  $\varnothing$  10 mm (0.394 in) with flange

2 Rod version with Clamp

3 Rod version with slotted nut

## 12.4 Industrial property rights

VEGA product lines are global protected by industrial property rights. Further information see [www.vega.com](http://www.vega.com).

VEGA Produktfamilien sind weltweit geschützt durch gewerbliche Schutzrechte.

Nähere Informationen unter [www.vega.com](http://www.vega.com).

Les lignes de produits VEGA sont globalement protégées par des droits de propriété intellectuelle. Pour plus d'informations, on pourra se référer au site [www.vega.com](http://www.vega.com).

VEGA líneas de productos están protegidas por los derechos en el campo de la propiedad industrial. Para mayor información revise la pagina web [www.vega.com](http://www.vega.com).

Линии продукции фирмы ВЕГА защищаются по всему миру правами на интеллектуальную собственность. Дальнейшую информацию смотрите на сайте [www.vega.com](http://www.vega.com).

VEGA系列产品在全球享有知识产权保护。

进一步信息请参见网站 < [www.vega.com](http://www.vega.com)。

## 12.5 Trademark

All the brands as well as trade and company names used are property of their lawful proprietor/originator.

## INDEX

**A**

Adjustment

- Max. adjustment 31, 32
- Min. adjustment 31, 32

Adjustment system 27

Application 30, 31

Application area 9

**B**

Backlight 36

**C**

Copy sensor settings 42

Curve display

- Echo curve 38

**D**

Damping 34

Date of manufacture 43

Date/Time 39

Default values 40

Deviation 58, 60

Device ID 43

Device status 37

Display format 36

**E**

Echo curve memory 54

Echo curve of the setup 39

EDD (Enhanced Device Description) 52

Electrical connection 20

Error codes 56

**F**

Factory calibration date 43

False signal suppression 33

Fault rectification 58

FF parameter 76

Functional principle 9

**G**

Gas phase 30

**I**

Inflowing medium 16

Installation position 14

**K**

Key function 26

**L**

Language 36

Linearisation 34

Lock adjustment 35

**M**

Main menu 28

Measured value indication 36

Measured value memory 53

Measurement reliability 37

**N**

NAMUR NE 107 54

- Failure 55

- Maintenance 57

- Out of specification 56

**P**

Peak indicator 37, 38

Probe length 29

Probe type 43

**Q**

Quick setup 28

**R**

Read out info 43

Repair 63

Replacement parts

- Spacer 12

Reset 40

**S**

Sensor characteristics 44

Service hotline 62

Simulation 38

Special parameters 43

**T**

Type label 7

Type of medium 29

**U**

Units 29

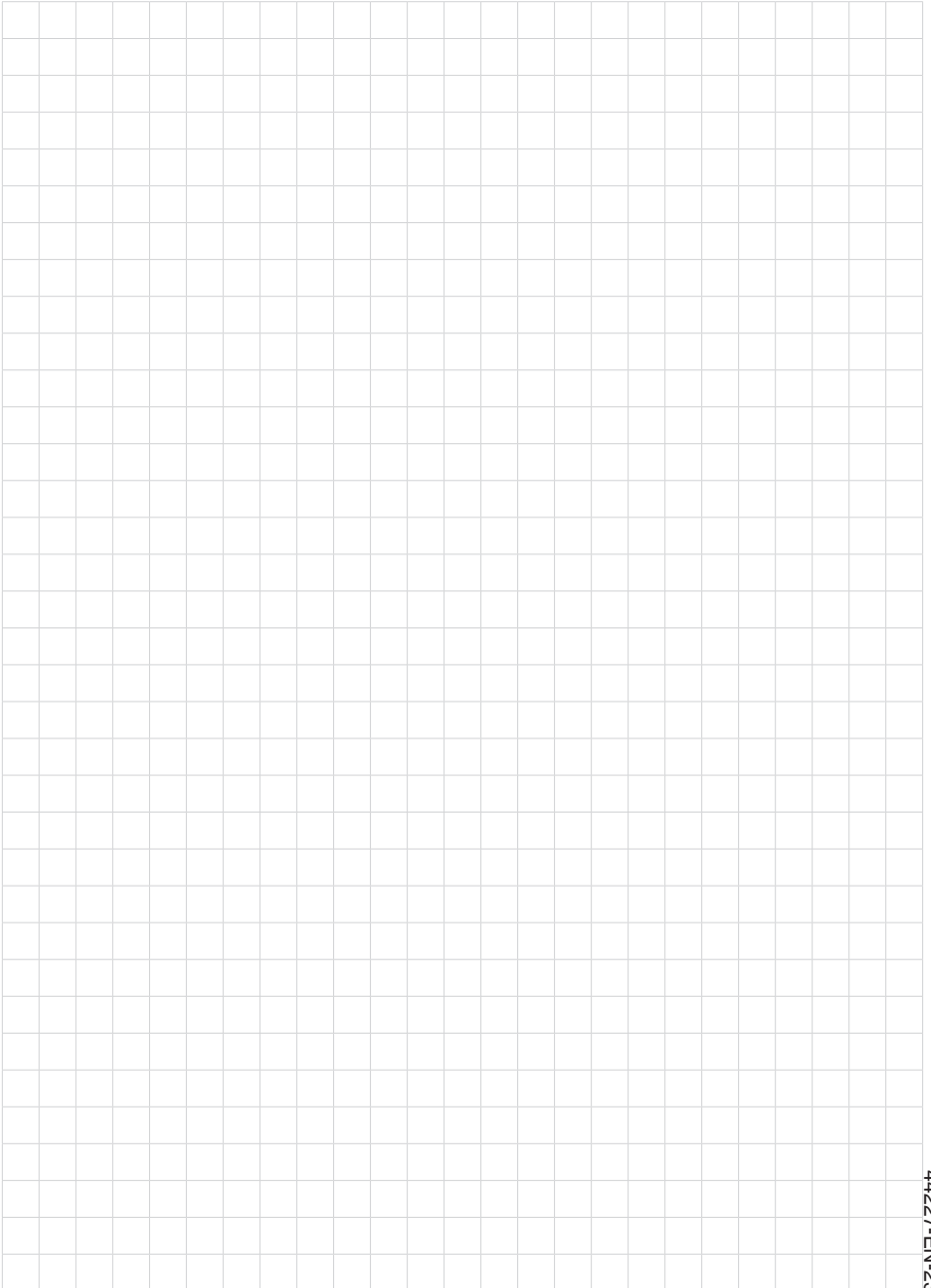

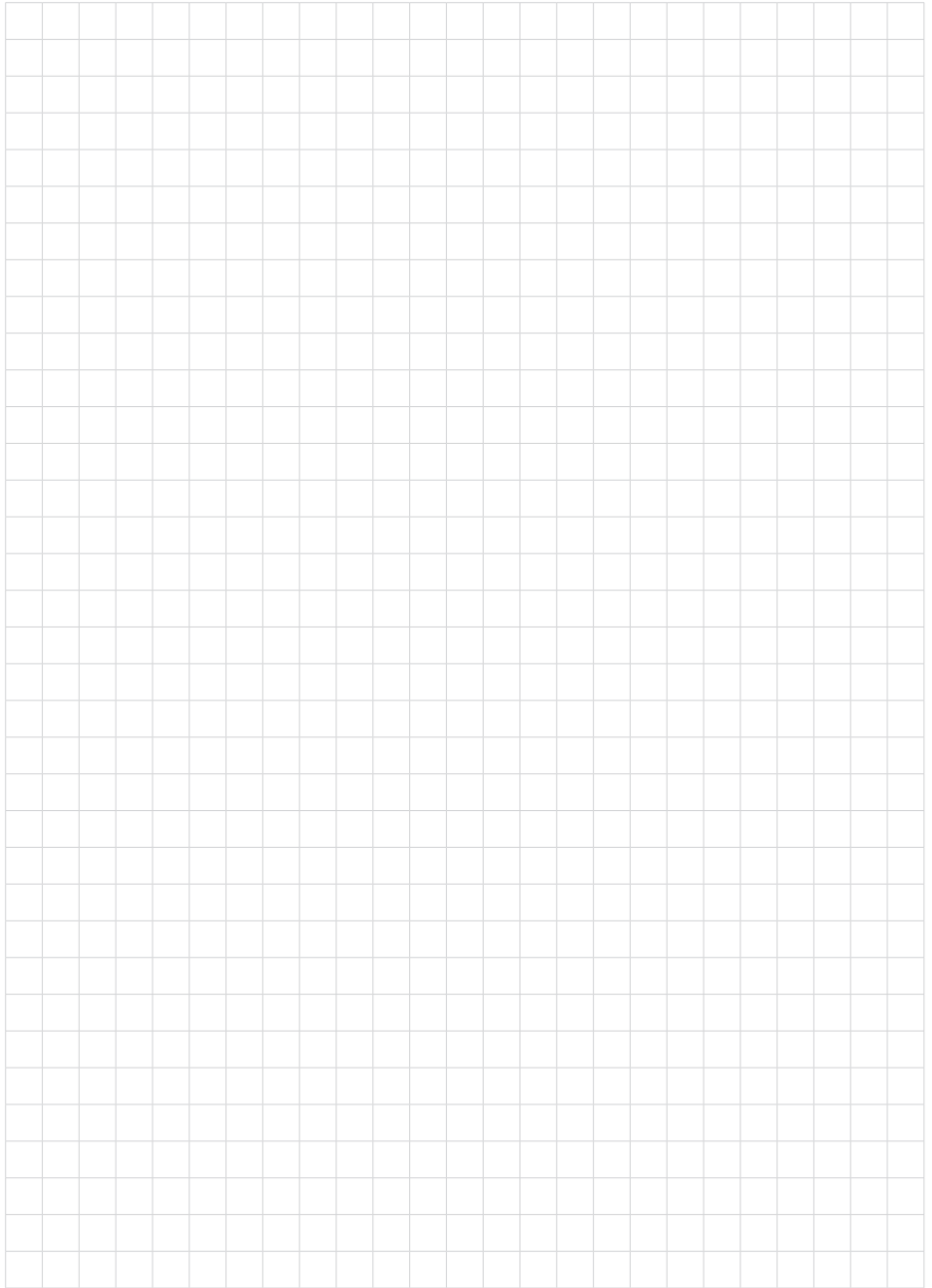

Printing date:

**VEGA**

All statements concerning scope of delivery, application, practical use and operating conditions of the sensors and processing systems correspond to the information available at the time of printing.

Subject to change without prior notice

© VEGA Grieshaber KG, Schiltach/Germany 2023



44227-EN-230605

VEGA Grieshaber KG  
Am Hohenstein 113  
77761 Schiltach  
Germany

Phone +49 7836 50-0  
E-mail: [info.de@vega.com](mailto:info.de@vega.com)  
[www.vega.com](http://www.vega.com)