



## Safety instructions

### VEGAMIP T61, R61, R62

Dust ignition protection by enclosure

BVS 09 ATEX E 132

Relay (DPDT)

Transistor (NPN/PNP)



CE 0044



Document ID: 43287



# VEGA

## Contents

<b>1</b>	<b>Area of applicability.....</b>	<b>4</b>
<b>2</b>	<b>Different ignition protection types .....</b>	<b>4</b>
<b>3</b>	<b>Important specification in the type code.....</b>	<b>5</b>
<b>4</b>	<b>General information.....</b>	<b>6</b>
<b>5</b>	<b>Application area.....</b>	<b>7</b>
<b>6</b>	<b>Special operating conditions.....</b>	<b>8</b>
<b>7</b>	<b>Important information for mounting and maintenance.....</b>	<b>8</b>
<b>8</b>	<b>Safe operating mode .....</b>	<b>11</b>
<b>9</b>	<b>Instructions for zone 20 applications .....</b>	<b>12</b>
<b>10</b>	<b>Potential equalization/Grounding .....</b>	<b>12</b>
<b>11</b>	<b>Electrostatic charging (ESD) .....</b>	<b>12</b>
<b>12</b>	<b>Electrical data.....</b>	<b>13</b>
<b>13</b>	<b>Thermal data .....</b>	<b>13</b>

Supplementary documentation:

- Operating instructions VEGAMIP T61, R61, R62
- EU type approval certificate BVS 09 ATEX E 132 (Document ID: 43288)
- EU declaration of conformity (Document ID: 42324)

Editing status: 2020-11-27

DE	Sicherheitshinweise für den Einsatz in explosionsgefährdeten Bereichen
EN	Safety instructions for the use in hazardous areas
FR	Consignes de sécurité pour une application en atmosphères explosibles
IT	Normative di sicurezza per l'impiego in luoghi con pericolo di esplosione
ES	Instrucciones de seguridad para el empleo en áreas con riesgo de explosión
PT	Normas de segurança para utilização em zonas sujeitas a explosão
NL	Veiligheidsaanwijzingen voor gebruik op plaatsen waar ontploffingsgevaar kan heersen
SV	Säkerhetsanvisningar för användning i explosionsfarliga områden
DA	Sikkerhedsforskrifter til anvendelse i explosionsfarlig atmosfære
FI	Turvallisuusohjeet räjähdysvaarallisissa tiloissa käyttöä varten
EL	Υποδείξεις ασφαλείας για τη χρησιμοποίηση σε περιοχές που υπάρχει κίνδυνος έκρηξης

DE	Die vorliegenden Sicherheitshinweise sind im Download unter <a href="http://www.vega.com">www.vega.com</a> standardmäßig in den Sprachen deutsch, englisch, französisch und spanisch verfügbar. Weitere EU-Landessprachen stellt VEGA nach Anforderungen zur Verfügung.
EN	These safety instructions are available as a standard feature in the download area under <a href="http://www.vega.com">www.vega.com</a> in the languages German, English, French and Spanish. Further EU languages will be made available by VEGA upon request.
FR	Les présentes consignes de sécurité sont disponibles au téléchargement sous <a href="http://www.vega.com">www.vega.com</a> en standard en allemand, en anglais, en français et en espagnol. VEGA met à disposition d'autres langues de l'Union Européenne selon les exigences.
ES	Las indicaciones de seguridad presentes están disponibles en la zona de descarga de <a href="http://www.vega.com">www.vega.com</a> de forma estándar en los idiomas inglés, francés y español. VEGA pone a disposición otros idiomas de la UE cuando son requeridos.

# 1 Area of applicability

These safety instructions apply to the microwave emitter/receiver for point level detection VEGAMIP of type series:

- VEGAMIP MPT61(\*).GX/DK\*\*\*\*T\*\*\*
- VEGAMIP MPR61(\*).GX/DK\*\*\*\*R/T\*\*\*
- VEGAMIP MPR62(\*).GX\*\*\*\*R/T\*\*\*\*

with the electronics versions

- R - Relay (DPDT)
- T - Transistor (NPN/PNP)

according to EU type approval certificate BVS 09 ATEX E 132 (certificate number on the type label) and for all instruments with safety instruction 43287.

The type of protection marking

II 1D Ex ta IIIC T.. Da IP66

II 1/2D Ex ta/tb IIIC T.. Da/Db IP66

II 1/3D Ex ta/tc IIIC T.. Da/Dc IP66

II 2D Ex tb IIIC T.. Db IP66

as well as the respective standards

EN IEC 60079-0: 2018

EN 60079-31: 2014

can be taken from the EU type approval certificate BVS 09 ATEX E 132, supplement 5:

The above mentioned versions can have further approvals apart from ignition protection type "protection by enclosure t".

The additional approvals are **not** subject of the assessment and evaluation acc. to the EU Type approval certificate BVS 09 ATEX E 132.

VEGAMIP MP*6*.	Approval	Combination		
	ATEX	Ex t	+ Ex ia	+ Ex d
DK	x	x		x
GX	x	x		

In the following, all above mentioned versions are called VEGAMIP T61, R61, R62. If parts of these safety instructions refer only to certain versions, then these will be mentioned explicitly with their type code.

# 2 Different ignition protection types

The VEGAMIP T61, R61 in version VEGAMIP MP\*61(\*).DK\*\*\*\*R/T\*\*\* can be either used in hazardous dust atmospheres or in hazardous gas atmospheres. The operator must specify the selected ignition protection type before installation. The selected ignition protection type must be marked by scratching off on the identification mark of the type label.

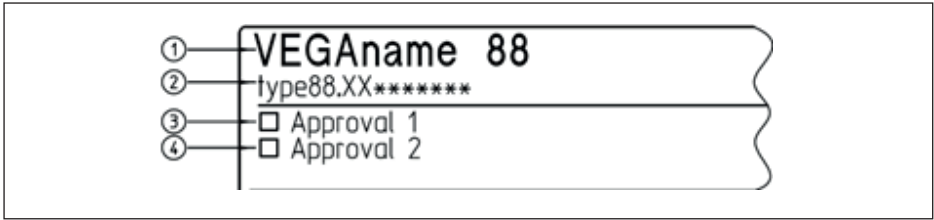

- 1 VEGAMIP T61, R61, R62
- 2 Instrument version
- 3 Identification label: Approval in dust ignition protection type e. g. „Ex t“
- 4 Identification label: Approval in Gas ignition protection type e. g. „Ex i“, „Ex d“

If VEGAMIP T61, R61, R62 is installed in a gas atmosphere, then the safety instructions and the instructions in the respective certificates must be noted:

Installation	Feature	Certificate	Safety instruction
Gas	"DX"	BVS 11 ATEX E 169	41679

### 3 Important specification in the type code

VEGAMIP MPT61(\*)**.aab\*\*def\*\***, MPR61(\*)**.aab\*\*def\*\***

Position		Feature	Description
a	Approval	DK	ATEX II 1/2G, 2G Ex d IIC Ga/Gb, Gb, II 1D, 1/2D, 1/3D, 2D Ex ta, ta/tb, ta/tc, tb IIIC T.. Da, Da/Db, Da/Dc, Db IP66
		GX	ATEX II 1D, 1/2D, 1/3D, 2D Ex ta, ta/tb, ta/tc, tb IIIC T.. Da, Da/Db, Da/Dc, Db IP66
b	Version / Material	A	Inside horn antenna (ø 1½") / 316L with PTFE cover
		B	with horn antenna (ø 40 mm) / 316L
		C	with horn antenna (ø 48 mm) / 316L
		D	with horn antenna (ø 75 mm) / 316L
		E	with horn antenna (ø 95 mm) / 316L
		F	Plastic horn antenna (ø 80 mm) / PP
		J	with horn antenna (ø 40 mm) / 1.4848
		X	For separate horn antenna
d	Seal / Process temperature	1	FKM (A+P FPM 70.16-06) / -40 ... +80 °C
		2	FKM (SHS FPM 70C3 GLT) / -40 ... +130 °C
		3	FFKM (Kalrez 6375) / -20 ... +130 °C
		4	PP / -40 ... +80 °C
		8	PTFE / -40 ... +200 °C
		9	PTFE+Viton / -25 ... +130 °C
		e	Electronics
T	Transistor (NPN/PNP) 20 ... 55 V DC		

Position		Feature	Description
f	Housing / Protection	A	Aluminium single chamber / IP66/IP68 (0.2 bar)
		V	Stainless steel single chamber (precision casting) / IP66/IP68 (0.2 bar)
		H	Special colour Aluminium / IP66/IP68 (0.2 bar)

#### MPR62(\*) .aab\*\*defg\*

Position		Feature	Description
a	Approval	GX	ATEX II 1D, 1/2D, 1/3D, 2D Ex ta, ta/tb, ta/tc, tb IIIC T.. Da, Da/Db, Da/Dc, Db IP66
b	Version / Material	A	Inside horn antenna (ø 1½") / 316L with PTFE cover
		B	with horn antenna (ø 40 mm) / 316L
		C	with horn antenna (ø 48 mm) / 316L
		D	with horn antenna (ø 75 mm) / 316L
		E	with horn antenna (ø 95 mm) / 316L
		F	Plastic horn antenna (ø 80 mm) / PP
		J	with horn antenna (ø 40 mm) / 1.4848
		X	For separate horn antenna
d	Seal / Process temperature	1	FKM (A+P FPM 70.16-06) / -40 ... +80 °C
		2	FKM (SHS FPM 70C3 GLT) / -40 ... +130 °C
		3	FFKM (Kalrez 6375) / -20 ... +130 °C
		4	PP / -40 ... +80 °C
		8	PTFE / -40 ... +200 °C
		9	PTFE+Viton / -25 ... +130 °C
e	Electronics	R	Relay (DPDT) 20 ... 72 V DC/20 ... 253 V AC (3 A) (only for MPR61)
		T	Transistor (NPN/PNP) 20 ... 55 V DC
f	Sensor housing / Protection	A	Aluminium single chamber / IP66/IP68 (0.2 bar)
		V	Stainless steel single chamber (precision casting) / IP66/IP68 (0.2 bar)
		H	Special colour Aluminium / IP66/IP68 (0.2 bar)
g	Housing / Protection	A	Aluminium single chamber / IP66/IP68 (0.2 bar)
		V	Stainless steel single chamber (precision casting) / IP66/IP68 (0.2 bar)
		H	Special colour Aluminium / IP66/IP68 (0.2 bar)

## 4 General information

The VEGAMIP are used for level detection of liquids and bulk solids.

The VEGAMIP consist of an electronics housing, the process fittings and a sensor or an antenna.

The VEGAMIP are suitable for use in areas with combustible, dust generating bulk solids of group IIIA, IIIB and IIIC. These sensors are suitable for applications requiring category 1D (EPL Da), 1/2D (EPL Da/Db), 1/3D (EPL Da/Dc) or 2D (EPL Db) instruments.

## 5 Application area

### Category 1D (EPL Da instruments)

The electronics housing and the antennas with the mechanical fixing element are installed in explosion-endangered areas of zone 20, in areas requiring instruments of category 1D (EPL Da).

### Category 1/2D (EPL Da/Db instruments)

The electronics housing is installed in hazardous areas of zone 21 requiring instruments of category 2D (EPL Db). The process connection element is installed in the separating wall, which separates areas requiring instruments of category 2D (EPL Db) or 1D (EPL Da). The sensor with the mechanical fixing element is installed in hazardous areas of zone 20 requiring instruments of category 1D (EPL Da).







### Category 1/3D (EPL Da/Dc instruments)



The electronics housing is installed in hazardous areas of zone 22 requiring a category 3D (EPL Dc) instrument.

The process connection cables come from an area where the use of a category 1D (EPL Da) instrument is required.

### Category 2D (EPL Db instruments)

The electronic housing and the sensor with the mechanical fixing element are installed in hazardous areas of zone 21, in areas requiring instruments of category 2D (EPL Db).

VEGA Instrument	3D (EPL Dc)	2D (EPL Db)	1/2D (EPL Da/Db)	1D (EPL Da)
Ex Zone 22 				
Ex Zone 21 				
Ex Zone 20 				

VEGA Instrument	1/3D (EPL Da/Dc)
Ex Zone 22 	
Ex Zone 20 	

## 6 Special operating conditions

### Ambient temperature

You can find the details in chapter " *Thermal data*" of these safety instructions.

### Impact and friction sparks

The VEGAMIP T61, R61, R62 in light metal versions (e.g. aluminium, titanium, zircon) must be mounted in such a way that sparks from impact and friction between light metals and steel (except stainless steel, if the presence of rust particles can be excluded) cannot occur.

### When used as Da/Db or Da/Dc instrument

For versions with standard process fittings, the installation must be made in such a way that at least protection rating IP67 acc. to IEC/EN 60529 is reached on the process fittings.

## 7 Important information for mounting and maintenance

### General instructions

The following requirements must be fulfilled for mounting, electrical installation, setup and maintenance of the instrument:

- The staff must be qualified according the respective tasks
- The staff must be trained in explosion protection
- The staff must be familiar with the respectively valid regulations, e.g. planning and installation acc. to IEC/EN 60079-14
- Make sure when working on the instrument (mounting, installation, maintenance) that there is no explosive atmosphere present, the supply circuits should be voltage-free, if possible.
- The instrument has to be mounted according to the manufacturer specifications, the EU type approval certificate and the valid regulations and standards
- Modifications on the instrument can influence the explosion protection and hence the safety, therefore repairs are not permitted to be conducted by the end user
- Modifications must only be carried out by employees authorized by VEGA company
- Use only approved spare parts
- Components for installation and connection not included in the approval documents are only permitted if these correspond technically to the latest standard mentioned on the cover sheet. They must be suitable for the application conditions and have a separate certificate. The special conditions of the components must be noted and if necessary, the components must be integrated in the type test. This applies also to the components already mentioned in the technical description.
- Vessel installations and probable flow must be taken into account

### Cable and wire entries

- The VEGAMIP T61, R61, R62 must be connected via suitable cable gland or conduit systems that are in conformity with the requirements of the flame proofing and the IP protection and provided with a separate type approval certificate. When connecting VEGAMIP T61, R61, R62 to conduit systems, the corresponding sealing facility must be connected directly to the housing.
- The red thread or/dust covers screwed in when the instruments are shipped (depending on the version) must be removed before setup and replaced by cable entries or closing screws suitable for the respective ignition protection type and IP protection.
- Note type and size of the thread: A label with the respective thread name is in the area of the respective thread
- Threads must have no damages
- Cable entries and closing screws should be mounted correctly and according to the safety instructions of the manufacturer to ensure the specified ignition protection type and IP protection rating. When using certified or suitable cable glands, closing screws or plug connections, it is



absolutely necessary to note the corresponding certificates/documents. Supplied cable entries or closing screws meet these requirements.

- Unused openings must be closed with plugs suitable for the ignition protection type and IP protection. Supplied plugs meet these requirements.
- Cable or wire entries resp. the closing screws must be tightly screwed into the housing
- The connection cables resp. pipeline sealing facilities must be suitable for the application conditions (e.g. temperature range) of the application
- With surface temperatures > 70 °C, the cables must be suitable for the higher application conditions
- The connection cable of VEGAMIP T61, R61, R62 has to be wired fix and in such a way that damages can be excluded.

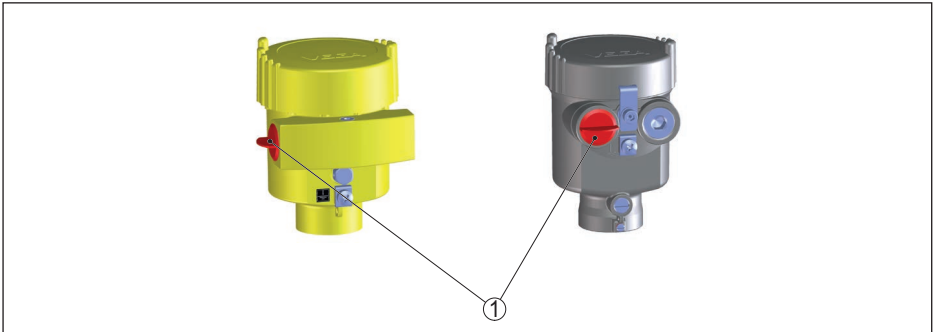

1 Red threaded or dust protection cap

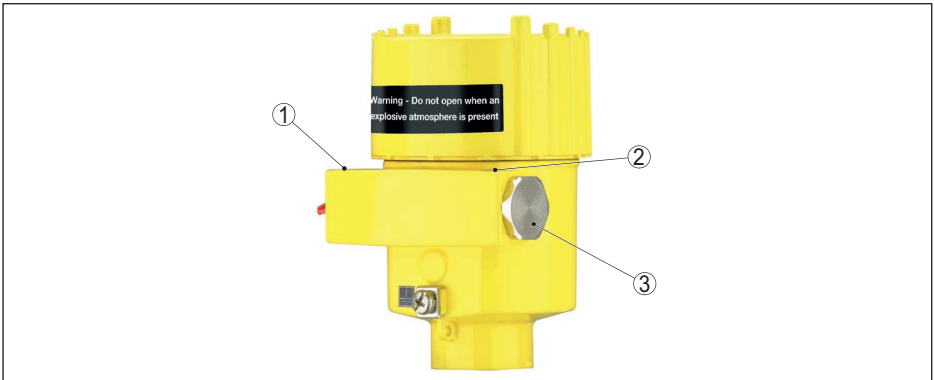

1 Label: Type and size of the thread ½-14 NPT or M20 x 1.5

2 Label: Type and size of the thread ½-14 NPT or M20 x 1.5

3 Screw plug

## Mounting

Keep in mind for instrument mounting

- Mechanical damage on the instrument must be avoided
- Mechanical friction must be avoided
- Vessel installations and probable flow must be taken into account
- Close the housing lid (s) up to the stop before starting operating, to ensure the IP protection rating specified on the type label

- Protect the lid against unauthorized opening by unscrewing the locking screw up to the stop.

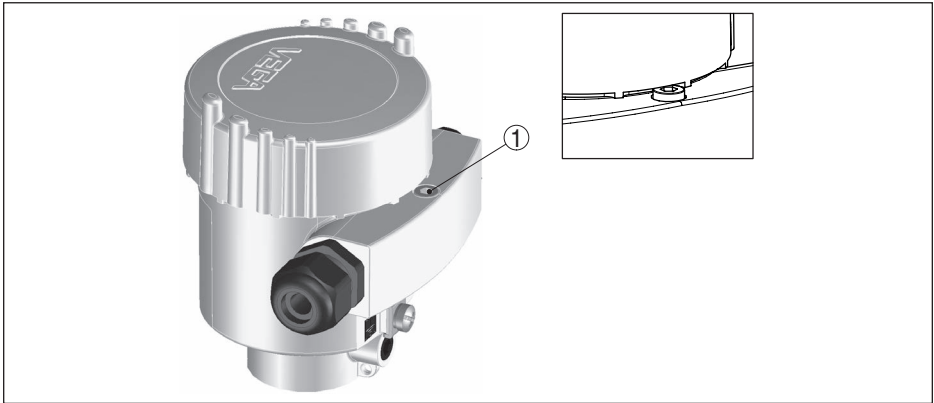

1 Locking screw of the lid

- The instruments must be mounted/installed in such a way that the following can be ruled out:
  - electrostatic charges during operation, maintenance and cleaning.
  - process-related electrostatic charges, e.g. by measuring media flowing past

**Cable glands, threaded openings**

Type	Thread	Cable diameter [mm]	Torques [Nm]
Hummel EXIOS A2F 1.608.2003.50	M20 x 1.5	6 ... 12 mm	8
Hummel EXIOS A2F 1.608.1203.70	½ NPT	6 ... 12 mm	8
Hummel EXIOS MZ 1.6Z5.2000.51	M20 x 1.5	9 ... 13 mm	8
Hummel EXIOS MZ 1.6Z5.1200.70	½ NPT	9 ... 13 mm	8
Hummel HSK-M-Ex 1.640.2000.51	M20 x 1.5	5 ... 9 mm	8

The specified tightening torques are test torques and are to be seen only as recommended values. These were determined according to the specifications of the listed valid standards. The tightening torques may deviate depending on the type and characteristic of the cables/lines. If assembly instructions of the manufacturer are provided, these must be observed.

If suitable cable glands or cable insertion possibilities not included in the scope of supply are used, these must be compatible with the threaded openings.

## Aluminium housing with M20 x 1.5 thread, 1/2 NPT thread

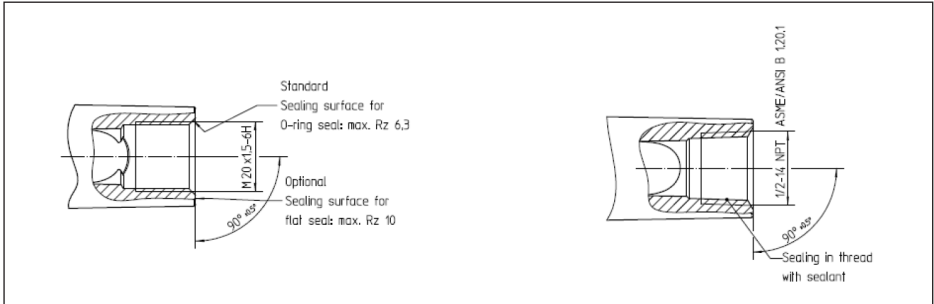

## Stainless-steel housing (fine cast) with M20 x 1.5 thread, 1/2 NPT thread

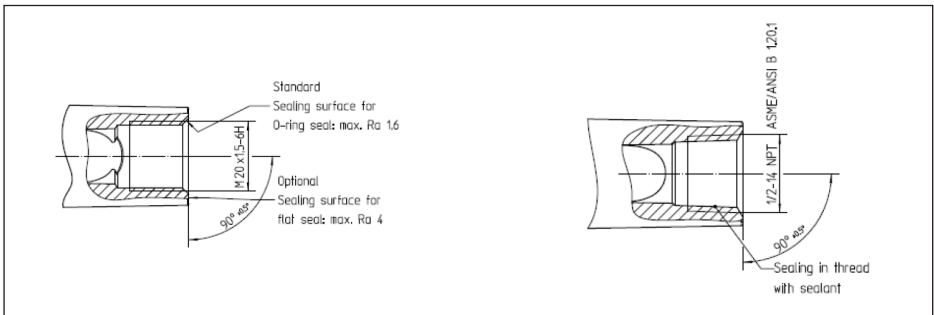

## 8 Safe operating mode

### General operating conditions

- Do not operate the instrument outside the electrical, thermal and mechanical specifications of the manufacturer
- Use the instrument only in media against which the wetted parts are sufficiently resistant
- Note the relation between process temperature on the sensor/antenna and the permissible ambient temperature on the electronics housing. For permissible temperatures, see the respective temperature tables. See chapter " *Thermal data*".
- If necessary, a suitable overvoltage arrester can be connected in front of the VEGAMIP T61, R61, R62
- Version with swivelling holder:
  - When using as instrument with EPL Ga/Gb in the versions with swivelling holder, keep in mind that the protection class IP67 is ensured when orientating the antenna by swivelling or after screwing the flange on.
- Version with rinsing connection:
  - For the VEGAMIP T61, R61, R62 in the version with rinsing connection, please make sure when using as instrument with EPL Ga/Gb that protection IP67 is ensured at the connection to the reflux valve. After removal of the reflux valve or the rinsing connection on the reflux valve, the opening must be closed with a suitable plug screw in order to maintain protection IP67.
- The VEGAMIP T61, R61, R62 must be installed in such a way that sensor (antenna) does not touch the vessel wall. Especially the inner tank structure, the flow conditions in the tank and the antenna length must be taken into account.

- Lids must not be opened if there is a hazardous atmosphere. The housing lids are marked with the warning label:

WARNING - DO NOT OPEN WHEN AN  
EXPLOSIVE ATMOSPHERE IS PRESENT

## 9 Instructions for zone 20 applications

In hazardous areas, the instrument should only be operated under atmospheric conditions:

- Temperature: -20 ... +60 °C.
- Pressure: 80 ... 110 kPa (0.8 ... 1.1 bar)
- Air with normal oxygen content, normally 21 %

If there are no explosive mixtures or supplementary measures, e.g. according to ISO/EN 1127-1, then the instruments can be also operated according to the manufacturer specifications outside atmospheric conditions.

Process fittings between an area requiring EPL Da and less endangered areas must show a tightness in accordance with protection rating IP67 acc. to IEC/EN 60529.

The operator must ensure that the medium temperature in the EPL Da range within the process vessel is not higher than 80 % of the self-ignition temperature of the concerned medium (in °C) and does not exceed the max. permissible flange temperature depending on the temperature class. The parts of the capacitive probe which during operation are in contact with flammable products, must be integrated in the periodic overpressure test of the plant.

When used as EPL Da/Db instrument, a suitable overvoltage arrester must be provided acc. to IEC/EN 60079-14 as protection against overvoltages.

## 10 Potential equalization/Grounding

- Integrate the instruments into the local potential equalisation, e.g. via the internal or external earth terminal
- The potential equalization terminal must be secured against loosening and twisting
- If grounding of the cable screening is necessary, this must be carried out acc. to the valid standards and regulations, e.g. acc. to IEC/EN 60079-14
- The intrinsically safe input and the intrinsically safe output circuits are ground-free. The voltage resistance against ground is min. 500 Veff.

## 11 Electrostatic charging (ESD)

In case of instrument versions with electrostatically chargeable plastic parts, the danger of electrostatic charging and discharging must be taken into account!

The following parts can charge and discharge:

- Lacquered housing version or alternative special lacquering
- Plastic housing, plastic housing parts
- Metal housing with inspection window
- Plastic process fittings
- Plastic-coated process fittings and/or plastic-coated sensors
- Connection cable for separate versions
- Type label
- Isolated metallic labels (measuring point identification plate)

Take note in case of danger of electrostatic charges:

- Avoid friction on the surfaces
- Do not dry clean the surfaces

The instruments must be mounted/installed in such a way that the following can be ruled out:

- in the case of extremely flammable dusts with a minimum ignition energy of less than 3 mJ, the device must not be used in areas where intensive electrostatic charging processes can be expected
- electrostatic charges during operation, maintenance and cleaning.
- process-related electrostatic charges, e.g. by measuring media flowing past

The warning label indicates danger:

WARNING - POTENTIAL ELECTROSTATIC  
CHARGING HAZARD - SEE INSTRUCTIONS

## 12 Electrical data

VEGAMIP MPT61(*).GX/DK****T*** Voltage supply: (terminals 1, 2) Power consumption Load current	U = 20 ... 253 V AC, 50/60 Hz or U = 20 ... 72 V DC 1.8 VA (AC), approx. 1.3 W (DC)
VEGAMIP MPR61(*).GX/DK****R****, MPR62(*).GX****R**** Voltage supply: (terminals 1, 2) Power consumption Relay circuit: Terminals 3, 4, 5 Terminals 6, 7, 8	U = 20 ... 253 V AC, 50/60 Hz U = 20 ... 72 V DC 1.8 VA (AC), approx. 1.3 W (DC) 253 V AC, 5 A 4 A, 30 V DC 0.2 A, 125 V DC
VEGAMIP MPT61(*).GX/DK****T****, MPT62(*).GX****T**** Voltage supply: (terminals 1, 2) Power consumption Transistor output: Terminals 4, 5	U = 20 ... 55 V DC max. 1 W U <sub>Load</sub> = 20 ... 55 V DC I <sub>Load</sub> ≤ 400 mA AC
Emitting/Receiver frequency Radiation power (normal operation) Radiation power (2-error analysis)	P <sub>EIRP</sub> = 0.1 DC P <sub>EIRP</sub> = 2.7 DC

## 13 Thermal data

The following temperature tables are valid for all housing and electronics versions.

### Permissible ambient temperatures

On the sensor: Device protection level (EPL) Da, Db	VEGAMIP MPT61(*).GX****T*** VEGAMIP MPR61(*).GX****R/T*** VEGAMIP MPR62(*).GX****R/T***	-40 ... +130 °C
	VEGAMIP MPT61(*).GX/DKA***T*** VEGAMIP MPR61(*).GX/DKA***R/T*** VEGAMIP MPR62(*).GXA***R/T***	-40 ... +80 °C
	VEGAMIP MPT61(*).GXF***T*** VEGAMIP MPR61(*).GXF***R/T*** VEGAMIP MPR62(*).GXF***R/T***	-40 ... +80 °C
	High temperature version VEGAMIP MPT61(*).GX****T*** VEGAMIP MPR61(*).GX****R/T*** VEGAMIP MPR62(*).GX****R/T***	-170 ... +250 °C
	Ceramic version VEGAMIP MPT61(*).GX****T*** VEGAMIP MPR61(*).GX****R/T*** VEGAMIP MPR62(*).GX****R/T***	-170 ... +450 °C

### Surface temperature increase

On the sensor: Device protection level (EPL) Da, Db	VEGAMIP MPT61(*).GX/DK****T*** VEGAMIP MPR61(*).GX/DK****R/T*** VEGAMIP MPR62(*).GX****R/T***	Process temperature +3 K
On the electronics housing: Device protection level (EPL) Da, Db, Dc	VEGAMIP MPT61(*).GX/DKA***T*** VEGAMIP MPR61(*).GX/DKA***R/T*** VEGAMIP MPR62(*).GXA***R/T***	Limited to +102 °C by temperature link

### Max. surface temperature on the sensor/antenna

The max. surface temperature of the instrument with which the hazardous dust atmosphere can come into contact, **is the higher** of the two specified surface temperatures on the electronics housing or the sensor/antenna.



Printing date:

# VEGA

All statements concerning scope of delivery, application, practical use and operating conditions of the sensors and processing systems correspond to the information available at the time of printing.

Subject to change without prior notice

© VEGA Grieshaber KG, Schiltach/Germany 2020



43287-EN-201204

VEGA Grieshaber KG  
Am Hohenstein 113  
77761 Schiltach  
Germany

Phone +49 7836 50-0  
Fax +49 7836 50-201  
E-mail: [info.de@vega.com](mailto:info.de@vega.com)  
[www.vega.com](http://www.vega.com)