

Operating Instructions

Conductive point level switch for liquids
(front-flush installation)

VEGAKON 61

Relay (DPDT)



Document ID: 32647



VEGA

Contents

1	About this document	3
1.1	Function	3
1.2	Target group	3
1.3	Symbols used.....	3
2	For your safety	4
2.1	Authorised personnel	4
2.2	Appropriate use.....	4
2.3	Warning about incorrect use.....	4
2.4	General safety instructions	4
2.5	Safety label on the instrument	5
2.6	EU conformity.....	5
2.7	Installation and operation in the USA and Canada	5
2.8	Environmental instructions	5
3	Product description	6
3.1	Configuration.....	6
3.2	Principle of operation.....	6
3.3	Adjustment	7
3.4	Storage and transport.....	7
4	Mounting	9
4.1	General instructions	9
4.2	Mounting instructions	10
5	Connecting to power supply	11
5.1	Preparing the connection	11
5.2	Connection instructions	11
5.3	Connection, relay module.....	12
6	Setup	14
6.1	General information.....	14
6.2	Adjustment elements.....	14
6.3	Function table.....	14
7	Maintenance and fault rectification	16
7.1	Maintenance	16
7.2	Electronics exchange	16
7.3	How to proceed if a repair is necessary.....	17
8	Dismount	18
8.1	Dismounting steps.....	18
8.2	Disposal	18
9	Supplement	19
9.1	Technical data	19
9.2	Dimensions	22
9.3	Industrial property rights.....	23
9.4	Trademark	23

1 About this document

1.1 Function

This operating instructions provides all the information you need for mounting, connection and setup as well as important instructions for maintenance, fault rectification, the exchange of parts and the safety of the user. Please read this information before putting the instrument into operation and keep this manual accessible in the immediate vicinity of the device.

1.2 Target group

This operating instructions manual is directed to trained personnel. The contents of this manual must be made available to the qualified personnel and implemented.

1.3 Symbols used



Document ID

This symbol on the front page of this instruction refers to the Document ID. By entering the Document ID on www.vega.com you will reach the document download.



Information, tip, note

This symbol indicates helpful additional information.



Caution: If this warning is ignored, faults or malfunctions can result.



Warning: If this warning is ignored, injury to persons and/or serious damage to the instrument can result.



Danger: If this warning is ignored, serious injury to persons and/or destruction of the instrument can result.



Ex applications

This symbol indicates special instructions for Ex applications.



SIL applications

This symbol indicates instructions for functional safety which must be taken into account particularly for safety-relevant applications.



List

The dot set in front indicates a list with no implied sequence.



Action

This arrow indicates a single action.



Sequence of actions

Numbers set in front indicate successive steps in a procedure.



Disposal

This symbol indicates special instructions for disposal.

2 For your safety

2.1 Authorised personnel

All operations described in this documentation must be carried out only by trained, qualified personnel authorised by the plant operator.

During work on and with the device, the required personal protective equipment must always be worn.

2.2 Appropriate use

The VEGAKON 61 is a sensor for point level detection.

You can find detailed information about the area of application in chapter " *Product description*".

Operational reliability is ensured only if the instrument is properly used according to the specifications in the operating instructions manual as well as possible supplementary instructions.

For safety and warranty reasons, any invasive work on the device beyond that described in the operating instructions manual may be carried out only by personnel authorised by the manufacturer. Arbitrary conversions or modifications are explicitly forbidden.

2.3 Warning about incorrect use

Inappropriate or incorrect use of this product can give rise to application-specific hazards, e.g. vessel overflow through incorrect mounting or adjustment. Damage to property and persons or environmental contamination can result. Also, the protective characteristics of the instrument can be impaired.

2.4 General safety instructions

This is a state-of-the-art instrument complying with all prevailing regulations and directives. The instrument must only be operated in a technically flawless and reliable condition. The operator is responsible for the trouble-free operation of the instrument. When measuring aggressive or corrosive media that can cause a dangerous situation if the instrument malfunctions, the operator has to implement suitable measures to make sure the instrument is functioning properly.

The safety instructions in this operating instructions manual, the national installation standards as well as the valid safety regulations and accident prevention rules must be observed by the user.

For safety and warranty reasons, any invasive work on the device beyond that described in the operating instructions manual may be carried out only by personnel authorised by the manufacturer. Arbitrary conversions or modifications are explicitly forbidden. For safety reasons, only the accessory specified by the manufacturer must be used.

To avoid any danger, the safety approval markings and safety tips on the device must also be observed.

2.5 Safety label on the instrument

The safety approval markings and safety tips on the device must be observed.

2.6 EU conformity

The device fulfils the legal requirements of the applicable EU directives. By affixing the CE marking, we confirm the conformity of the instrument with these directives.

The EU conformity declaration can be found on our homepage.

2.7 Installation and operation in the USA and Canada

This information is only valid for USA and Canada. Hence the following text is only available in the English language.

Installations in the US shall comply with the relevant requirements of the National Electrical Code (ANSI/NFPA 70).

Installations in Canada shall comply with the relevant requirements of the Canadian Electrical Code.

2.8 Environmental instructions

Protection of the environment is one of our most important duties. That is why we have introduced an environment management system with the goal of continuously improving company environmental protection. The environment management system is certified according to DIN EN ISO 14001.

Please help us fulfil this obligation by observing the environmental instructions in this manual:

- Chapter "*Packaging, transport and storage*"
- Chapter "*Disposal*"

3 Product description

3.1 Configuration

Scope of delivery

The scope of delivery encompasses:

- VEGAKON 61 compact level switch
- Documentation
 - This operating instructions manual

Constituent parts

The VEGAKON 61 consists of the components:

- Housing lid
- Housing with electronics
- Process fitting

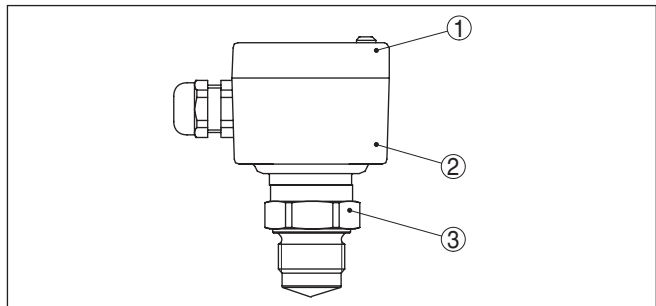

Fig. 1: VEGAKON 61

- 1 Housing lid
- 2 Housing with electronics
- 3 Process fitting

Serial number - Instrument search

The type label contains the serial number of the instrument. With it you can find the following instrument data on our homepage:

- Product code (HTML)
- Delivery date (HTML)
- Order-specific instrument features (HTML)
- Operating instructions and quick setup guide at the time of shipment (PDF)
- Order-specific sensor data

Move to "www.vega.com" and enter in the search field the serial number of your instrument.

Alternatively, you can access the data via your smartphone:

- Download the VEGA Tools app from the "*Apple App Store*" or the "*Google Play Store*"
- Scan the DataMatrix code on the type label of the instrument or
- Enter the serial number manually in the app

3.2 Principle of operation

Application area

The conductive VEGAKON 61 compact level switches detect levels of conductive liquids.

Functional principle

When the annular electrode is covered with a conductive medium, small alternating currents (< 1 mA) flow from the measuring electrode to the reference and neutralisation electrode.

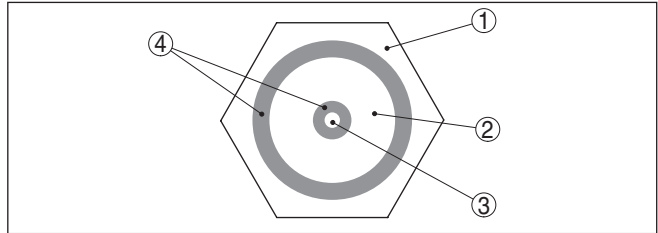

Fig. 2: Annular electrode

- 1 Reference electrode (mounting boss)
- 2 Neutralisation electrode
- 3 Measuring electrode
- 4 insulation

These alternating currents are measured in respect to their amplitude and phase position and converted into a switching command.

Interfering buildup is automatically eliminated via the neutralisation electrode, the conductivity detected and the switching point sensitivity derived thereof. An adjustment of the instrument is not necessary.

VEGAKON 61 can be used for reliable detection of products over a very wide conductivity and viscosity range.

Voltage supply

VEGAKON 61 is a compact instrument, i.e. it can be operated without external evaluation system. The integrated electronics evaluates the level signal and outputs a switching signal. With this switching signal, a connected device can be operated directly (e.g. a warning system, a pump etc.).

The data for power supply are specified in chapter " *Technical data*".

3.3 Adjustment

The VEGAKON 61 is a compact level switch with integrated electronics module.

On the electronics module you will find the following display and adjustment elements:

- Control lamp for indication of the switching status
- Mode changeover for selection of the output signal

3.4 Storage and transport

Your instrument was protected by packaging during transport. Its capacity to handle normal loads during transport is assured by a test based on ISO 4180.

The packaging of standard instruments consists of environment-friendly, recyclable carton material. The sensing element is additionally protected with a cardboard cover. For special versions, PE foam or

Packaging

PE foil is also used. Please dispose of the packaging material through specialised recycling companies.

Transport

Transport must be carried out in due consideration of the notes on the transport packaging. Nonobservance of these instructions can cause damage to the device.

Transport inspection

The delivery must be checked for completeness and possible transit damage immediately at receipt. Ascertained transit damage or concealed defects must be appropriately dealt with.

Storage

Up to the time of installation, the packages must be left closed and stored according to the orientation and storage markings on the outside.

Unless otherwise indicated, the packages must be stored only under the following conditions:

- Not in the open
- Dry and dust free
- Not exposed to corrosive media
- Protected against solar radiation
- Avoiding mechanical shock and vibration

Storage and transport temperature

- Storage and transport temperature see chapter "*Supplement - Technical data - Ambient conditions*"
- Relative humidity 20 ... 85 %

Lifting and carrying

With instrument weights of more than 18 kg (39.68 lbs) suitable and approved equipment must be used for lifting and carrying.

4 Mounting

4.1 General instructions

Process conditions



Note:

For safety reasons, the instrument must only be operated within the permissible process conditions. You can find detailed information on the process conditions in chapter " *Technical data*" of the operating instructions or on the type label.

Hence make sure before mounting that all parts of the instrument exposed to the process are suitable for the existing process conditions.

These are mainly:

- Active measuring component
- Process fitting
- Process seal

Process conditions in particular are:

- Process pressure
- Process temperature
- Chemical properties of the medium
- Abrasion and mechanical influences

Suitability for the ambient conditions

The instrument is suitable for standard and extended ambient conditions acc. to DIN/EN/IEC/ANSI/ISA/UL/CSA 61010-1. It can be used indoors as well as outdoors.

Moisture

Use the recommended cables (see chapter " *Connecting to power supply*") and tighten the cable gland.

You can give your instrument additional protection against moisture penetration by leading the connection cable downward in front of the cable gland. For this reason, the housing can be turned without any tools by 270°. Rain and condensation water can thus drain off. This applies mainly to outdoor mounting as well as installation in areas where high humidity is expected (e.g. through cleaning processes) or on cooled or heated vessels.

To maintain the housing protection, make sure that the housing lid is closed during operation and locked, if necessary.

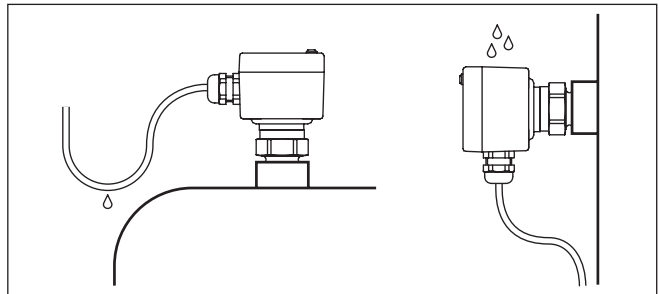

Fig. 3: Measures against moisture ingress

Pressure/Vacuum

The process fitting must be sealed if there is gauge or low pressure in the vessel. Before use, check if the sealing material is resistant against the measured product and the process temperature.

The max. permissible pressure is specified in chapter " *Technical data*" or on the type label of the sensor.

**Cable entries - NPT thread
Cable glands****Metric threads**

In the case of instrument housings with metric thread, the cable glands are screwed in at the factory. They are sealed with plastic plugs as transport protection.

You have to remove these plugs before electrical connection.

NPT thread

In the case of instrument housings with self-sealing NPT threads, it is not possible to have the cable entries screwed in at the factory. The free openings for the cable glands are therefore covered with red dust protection caps as transport protection.

Prior to setup you have to replace these protective caps with approved cable glands or close the openings with suitable blind plugs.

4.2 Mounting instructions

Welded socket

Remove the supplied seal from the thread of VEGAKON 61. This seal is not required when using the welded socket with O-ring in front.

Before welding, unscrew VEGAKON 61 and remove the rubber ring from the welded socket.

5 Connecting to power supply

5.1 Preparing the connection

Note safety instructions Always keep in mind the following safety instructions:



Warning:

Connect only in the complete absence of line voltage.

- The electrical connection must only be carried out by trained, qualified personnel authorised by the plant operator.
- Always switch off power supply, before connecting or disconnecting the instrument.



Note:

Install a disconnecting device for the instrument which is easy to access. The disconnecting device must be marked for the instrument (IEC/EN 61010).

Voltage supply

Connect the voltage supply according to the following connection diagrams. The electronics module KONE60R is designed in protection class I. To maintain this protection class, it is absolutely necessary that the ground conductor be connected to the internal ground terminal. Take note of the general installation regulations.

The data for power supply are specified in chapter " *Technical data*".

Connection cable

The instrument is connected with standard three-wire cable without shielding. If electromagnetic interference is expected which is above the test values of EN 61326 for industrial areas, shielded cable should be used.

Make sure that the cable used has the required temperature resistance and fire safety for max. occurring ambient temperature

Use cable with round cross-section. A cable outer diameter of 5 ... 9 mm (0.2 ... 0.35 in) ensures the seal effect of the cable gland. If you are using cable with a different diameter or cross-section, exchange the seal or use a suitable cable gland.

5.2 Connection instructions



Danger:

Switch off power supply before starting connection work.

Connect mains voltage according to the connection diagrams.

Connection to a PLC

If inductive loads or stronger currents are switched through, the gold plating on the relay contact surface will be permanently damaged. The contact is then no longer suitable for switching low-voltage circuits.

Inductive loads also result from the connection to a PLC input or output and/or in combination with long cables. It is imperative that you take measures to extinguish sparks to protect the relay contact (e.g. Z diode) or use an electronic version with transistor output.

6 Setup

6.1 General information

Function/Configuration

On the electronics module you will find the following display and adjustment elements:

- DIL switch for mode adjustment
- Control lamp for indication of the switching status

6.2 Adjustment elements

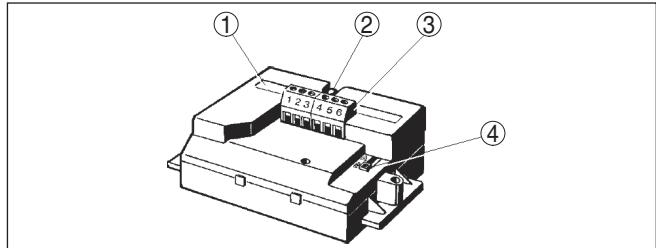

- 1 Type label
- 2 Control lamp (LED)
- 3 Connection terminals
- 4 Mode switch (A/B)

Mode setting (4)



With the mode adjustment (A/B) you can change the switching condition of the output. You can set the required mode according to the "Function table" (A - max. detection or overflow protection, B - min. detection or dry run protection).







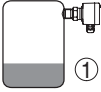

Signal lamp (2)

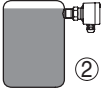
The switching condition of the signal lamp can be checked when the housing is closed. To adjust VEGAKON 61 loosen the four screws with a wrench on the upper side of the instrument and remove the housing cover.

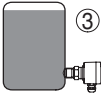
6.3 Function table

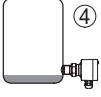
The following table provides an overview of the switching conditions depending on the set mode and the level.

	Level	Switching status, relay module E60R	Control lamp
Mode A Overflow protection		 Relay energized	 does not light

	Level	Switching status, relay module E60R	Control lamp
Mode A Overflow protection		 Relay deenergized	 lights
Mode B Dry run protection		 Relay energized	 does not light
Mode B Dry run protection		 Relay deenergized	 lights
Failure of the supply voltage (mode A/B)		 Relay deenergized	

- 1 Max. detection - Vessel empty
- 2 Max. detection - Vessel full
- 3 Min. detection - Vessel full
- 4 Min. detection - Vessel empty

7 Maintenance and fault rectification

7.1 Maintenance

Maintenance

If the device is used properly, no special maintenance is required in normal operation.

Cleaning

The cleaning helps that the type label and markings on the instrument are visible.

Take note of the following:

- Use only cleaning agents which do not corrode the housings, type label and seals
- Use only cleaning methods corresponding to the housing protection rating

7.2 Electronics exchange

In general, all electronics modules of series KONE60 can be interchanged. If you want to use an electronics module with a different signal output, you can download the corresponding operating instructions manual from our homepage under Downloads.

Proceed as follows:

1. Switch off voltage supply
 2. Unscrew the housing lid
 3. Loosen compression fittings with a screwdriver
 4. Pull the connection cables out of the terminals
 5. Loosen the two screws with a screw driver (Phillips recessed head)
 6. Pull out old electronics module
 7. Compare the new electronics module with the old one. The type label of the electronics module must correspond to that of the old electronics module.
 8. Note settings of all adjustment elements of the old electronics module.
Set the adjustment elements of the new electronics module to the same settings of the old one.
 9. Screw in and tighten the two holding screws with a screwdriver (Phillips)
 10. Insert the wire ends into the open terminals according to the wiring plan
 11. Tighten the screw terminals
 12. Check the hold of the wires in the terminals by lightly pulling on them
 13. Check cable gland on tightness. The seal ring must completely encircle the cable.
 14. Screw the housing lid back on
- The electronics exchange is now finished.

As soon as you insert the electronics module, VEGAKON 61 is ready for operation.

7.3 How to proceed if a repair is necessary

You can find an instrument return form as well as detailed information about the procedure in the download area of our homepage. By doing this you help us carry out the repair quickly and without having to call back for needed information.

In case of repair, proceed as follows:

- Print and fill out one form per instrument
- Clean the instrument and pack it damage-proof
- Attach the completed form and, if need be, also a safety data sheet outside on the packaging
- Ask the agency serving you to get the address for the return shipment. You can find the agency on our homepage.

8 Dismount

8.1 Dismounting steps

**Warning:**

Before dismounting, be aware of dangerous process conditions such as e.g. pressure in the vessel, high temperatures, corrosive or toxic products etc.

Take note of chapters "*Mounting*" and "*Connecting to voltage supply*" and carry out the listed steps in reverse order.

8.2 Disposal



Pass the instrument on to a specialised recycling company and do not use the municipal collecting points.

Remove any batteries in advance, if they can be removed from the device, and dispose of them separately.

If personal data is stored on the old device to be disposed of, delete it before disposal.

If you have no way to dispose of the old instrument properly, please contact us concerning return and disposal.

9 Supplement

9.1 Technical data

Note for approved instruments

The technical data in the respective safety instructions which are included in delivery are valid for approved instruments (e.g. with Ex approval). These data can differ from the data listed herein, for example regarding the process conditions or the voltage supply.

All approval documents can be downloaded from our homepage.

General data

Material 316L corresponds to 1.4404 or 1.4435

Materials, wetted parts

- Process fitting - thread	316Ti
- Process fitting - Cone	316Ti
- Electrode	316Ti
- Insulation ring	PTFE
- Process seal	Klingsil C-4400

Materials, non-wetted parts

- Housing	Plastic PBT (Polyester)
- Temperature adapter	316Ti
- Seal between housing and housing lid	Silicone
- Ground terminal	316L
- Cable gland	PA, stainless steel, brass
- Sealing, cable gland	NBR
- Blind plug, cable gland	PA

Weights

- With plastic housing	600 g (21 oz)
- Temperature adapter	150 g (5.3 oz)

Process fittings

- Thread (DIN 3852-A)	G1 (PN 25)
- Cone	Cone DN 25 (PN 25)
- Tuchenhagen	

Measurement voltage

approx. 1 V_{ss}, 5 kHz

Measurement current

< 1 mA

Output variable

Output	Relay output (DPDT), 1 floating spdt
Switching voltage	max. 253 V AC/DC
Switching current	max. 3 A AC (cos phi > 0,9), 1 A DC
Breaking capacity	
- Min.	50 mW

- Max.	750 VA AC, 40 W DC (bei U < 40 V DC) If inductive loads or stronger currents are switched through, the gold plating on the relay contact surface will be permanently damaged. The contact is then no longer suitable for switching low-level signal circuits.
Contact material (relay contacts)	AgNi or AgSnO ₂ each with 3 µm gold plating
Modes (switchable)	
- A	Max. detection or overflow/overflow protection
- B	Min. detection or dry run protection
Switching delay	
- When immersed	0.5 s
- When laid bare	0.5 s

Ambient conditions

Ambient temperature on the housing	-40 ... +70 °C (-40 ... +158 °F)
Ambient temperature with operating voltage > 60 V DC	-40 ... +50 °C (-40 ... +122 °F)
Storage and transport temperature	-40 ... +80 °C (-40 ... +176 °F)

Process conditions

Permissible process temperature

- Without temperature adapter -40 ... +100 °C (-40 ... +212 °F)
- with temperature adapter -40 ... +150 °C (-40 ... +302 °F)

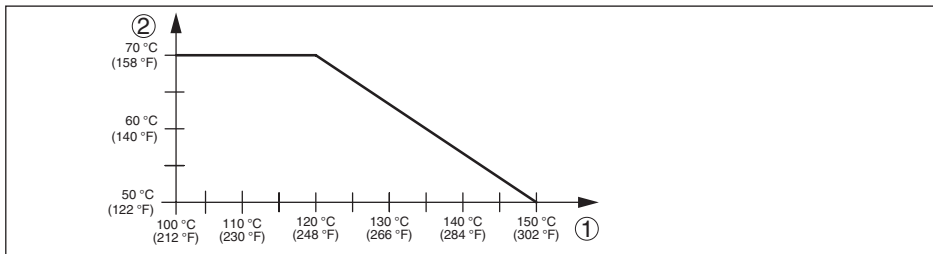

Fig. 5: Ambient temperature - Process temperature

- 1 Process temperature in °C
- 2 Ambient temperature in °C

Process pressure	-1 ... 25 bar/-100 ... 2500 kPa (-14.5 ... 362 psig)
Conductance of the medium	min. 7.5 µS/cm

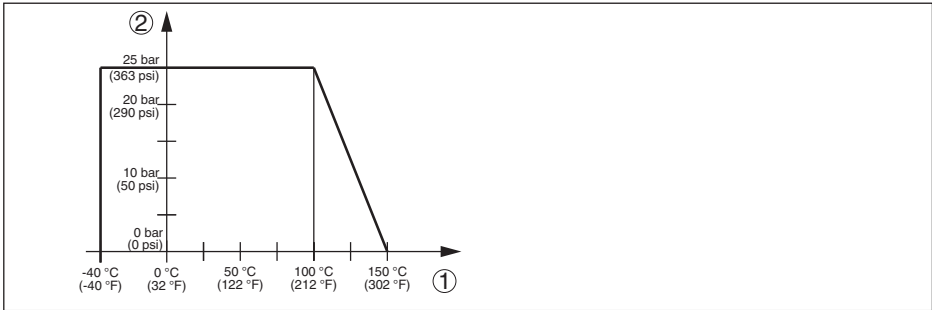

Fig. 6: Process temperature - Process pressure

1 Process temperature in °C

2 Process pressure in bar

Electromechanical data

Options of the cable entry

- Cable entry M20 x 1.5
- Cable gland M20 x 1.5
- Blind plug M20 x 1.5

Wire cross-section (screw terminals)

- Massive wire, stranded wire 0.2 ... 2.5 mm² (AWG 24 ... 14)
- Stranded wire with end sleeve 0.2 ... 1.5 mm² (AWG 24 ... 16)

Voltage supply

Operating voltage 20 ... 253 V AC, 50/60 Hz, 20 ... 72 V DC (at U >60 V DC, the ambient temperature can be max. 50 °C/122 °F)

Power consumption 1 ... 8 VA (AC), approximately 1.3 W (DC)

Electrical protective measures

Protection rating	IP66 (NEMA Type 4X)
Pollution degree ¹⁾	4
Overtoltage category	III
Protection class	I

¹⁾ When used with fulfilled housing protection

9.2 Dimensions

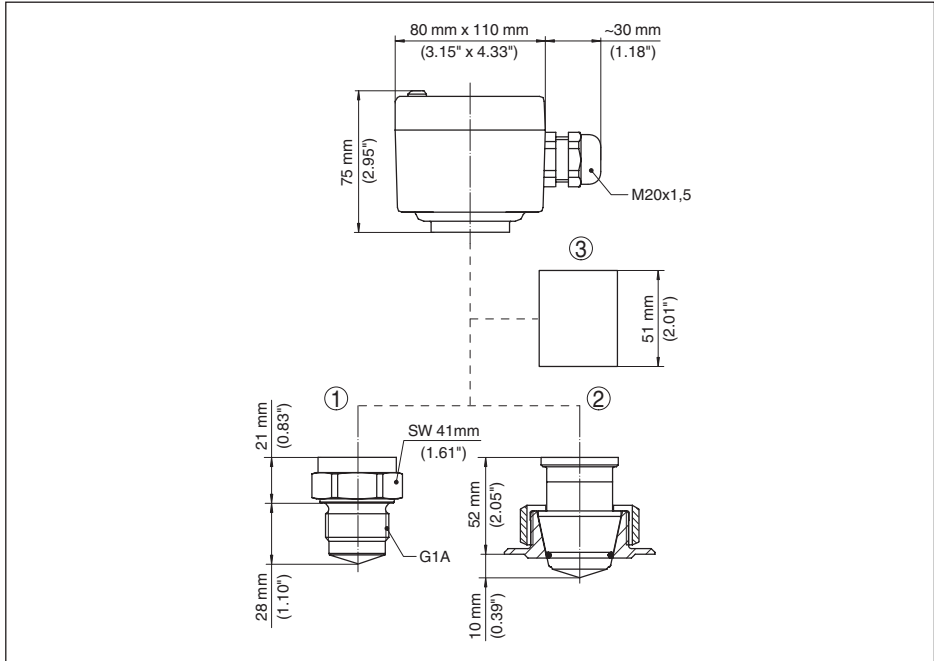

Fig. 7: VEGAKON 61

- 1 Threaded version
- 2 Cone version
- 3 Temperature adapter

9.3 Industrial property rights

VEGA product lines are global protected by industrial property rights. Further information see www.vega.com.

VEGA Produktfamilien sind weltweit geschützt durch gewerbliche Schutzrechte.

Nähere Informationen unter www.vega.com.

Les lignes de produits VEGA sont globalement protégées par des droits de propriété intellectuelle. Pour plus d'informations, on pourra se référer au site www.vega.com.

VEGA lineas de productos están protegidas por los derechos en el campo de la propiedad industrial. Para mayor información revise la pagina web www.vega.com.

Линии продукции фирмы ВЕГА защищаются по всему миру правами на интеллектуальную собственность. Дальнейшую информацию смотрите на сайте www.vega.com.

VEGA系列产品在全球享有知识产权保护。

进一步信息请参见网站 < www.vega.com。

9.4 Trademark

All the brands as well as trade and company names used are property of their lawful proprietor/originator.

Printing date:

VEGA

All statements concerning scope of delivery, application, practical use and operating conditions of the sensors and processing systems correspond to the information available at the time of printing.

Subject to change without prior notice

© VEGA Grieshaber KG, Schiltach/Germany 2022



32647-EN-220324

VEGA Grieshaber KG
Am Hohenstein 113
77761 Schiltach
Germany

Phone +49 7836 50-0
E-mail: info.de@vega.com
www.vega.com