

## Quick setup guide

Radar sensor for continuous level  
measurement of liquids and bulk solids

### VEGAPULS 6X

Two-wire 4 ... 20 mA/HART  
with overvoltage protection



Document ID: 66444



# VEGA

# Contents

- 1 For your safety ..... 3**
  - 1.1 Authorised personnel ..... 3
  - 1.2 Appropriate use..... 3
  - 1.3 Warning about incorrect use..... 3
  - 1.4 General safety instructions ..... 3
  - 1.5 Mode of operation - Radar signal ..... 4
  - 1.6 Installation and operation in the USA and Canada ..... 4
- 2 Product description ..... 5**
  - 2.1 Configuration..... 5
- 3 Setup - the most important steps..... 6**
- 4 Mounting ..... 7**
  - 4.1 Mounting instructions ..... 7
- 5 Connecting to power supply..... 9**
  - 5.1 Connecting..... 9
  - 5.2 Wiring plan, double chamber housing ..... 10
- 6 Set up with the display and adjustment module ..... 11**
  - 6.1 Insert display and adjustment module ..... 11
  - 6.2 Parameterization ..... 11
- 7 Setup with smartphone/tablet (Bluetooth)..... 18**
  - 7.1 Preparations..... 18
  - 7.2 Connecting..... 18
  - 7.3 Parameter adjustment ..... 19
- 8 Menu overview ..... 21**
  - 8.1 Display and adjustment module ..... 21
- 9 Supplement ..... 24**
  - 9.1 Technical data ..... 24



**Information:**

This quick setup guide enables quick setup and commissioning of your instrument.

You can find supplementary information in the corresponding, more detailed Operating Instructions Manual as well as the Safety Manual that comes with instruments with SIL qualification. These manuals are available on our homepage.

**Operating instructions VEGAPULS 6X - Two-wire 4 ... 20 mA/  
HART with overvoltage protection: Document-ID 66442**  
Editing status of the quick setup guide: 2024-03-07

# 1 For your safety

## 1.1 Authorised personnel

All operations described in this documentation must be carried out only by trained and authorized personnel.

During work on and with the device, the required personal protective equipment must always be worn.

## 1.2 Appropriate use

VEGAPULS 6X is a sensor for continuous level measurement.

You can find detailed information about the area of application in chapter "*Product description*".

Operational reliability is ensured only if the instrument is properly used according to the specifications in this document as well as possible supplementary instructions.

## 1.3 Warning about incorrect use

Inappropriate or incorrect use of this product can give rise to application-specific hazards, e.g. vessel overflow through incorrect mounting or adjustment. Damage to property and persons or environmental contamination can result. Also, the protective characteristics of the instrument can be impaired.

## 1.4 General safety instructions

This is a state-of-the-art instrument complying with all prevailing regulations and directives. The instrument must only be operated in a technically flawless and reliable condition. The operating company is responsible for the trouble-free operation of the instrument. When measuring aggressive or corrosive media that can cause a dangerous situation if the instrument malfunctions, the operating company has to implement suitable measures to make sure the instrument is functioning properly.

The safety instructions in this instructions manual, the national installation standards as well as the valid safety regulations and accident prevention rules must be observed.

For safety and warranty reasons, any invasive work on the device beyond that described in this instructions manual may be carried out only by personnel authorised by us. Arbitrary conversions or modifications are explicitly forbidden. For safety reasons, only the accessory specified by us must be used.

To avoid any danger, the safety approval markings and safety tips on the device must also be observed.

The low transmitting power of the radar sensor is far below the internationally approved limits. No health impairments are to be expected with intended use. The band range of the measuring frequency can be found in chapter "*Technical data*".

## 1.5 Mode of operation - Radar signal

Country or region specific settings for the radar signals are determined via the mode. The operating mode must be set in the operating menu via the respective operating tool at the beginning of the setup.



### **Caution:**

Operating the device without selecting the relevant mode constitutes a violation of the regulations of the radio approvals of the respective country or region.

## 1.6 Installation and operation in the USA and Canada

This information is only valid for USA and Canada. Hence the following text is only available in the English language.

Installations in the US shall comply with the relevant requirements of the National Electrical Code (NEC - NFPA 70) (USA).

Installations in Canada shall comply with the relevant requirements of the Canadian Electrical Code (CEC Part I) (Canada).

A Class 2 power supply unit has to be used for the installation in the USA and Canada.

## 2 Product description

### 2.1 Configuration

#### Type label

The type label contains the most important data for identification and use of the instrument:

- Instrument type
- Information about approvals
- Configuration information
- Technical data
- Serial number of the instrument
- QR code for device identification
- Numerical code for Bluetooth access (optional)
- Manufacturer information

#### Documents and software

To find order data, documents or software related to your device, you have the following options:

- Move to "[www.vega.com](http://www.vega.com)" and enter in the search field the serial number of your instrument.
- Scan the QR code on the type label.
- Open the VEGA Tools app and enter the serial number under "**Documentation**".

### 3 Setup - the most important steps

#### Prepare

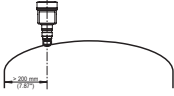
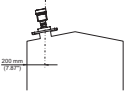

What?	How?
Identify sensor 	Scan QR code on type label, check sensor data

#### Mount and connect sensor

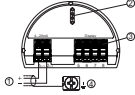

Liquids	Bulk solids
	

Connection technology	Wiring plan
	

#### Select adjustment

Display and adjustment module	VEGA Tools app <sup>1)</sup>
	

#### Parameterize sensor

Liquids	Bulk solids
Enter medium type, application, vessel height, adjustment and mode	
	

#### Check measured value

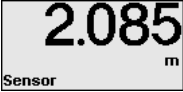
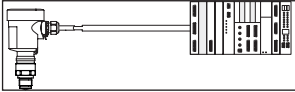
Indicators	Output
	

<sup>1)</sup> Download via Apple App Store, Google Play Store, Baidu Store

## 4 Mounting

### 4.1 Mounting instructions

#### Polarisation

Radar sensors for level measurement emit electromagnetic waves. The polarisation is the direction of the electrical share of these waves. It is identifiable by a mark on the housing, see the following drawing:

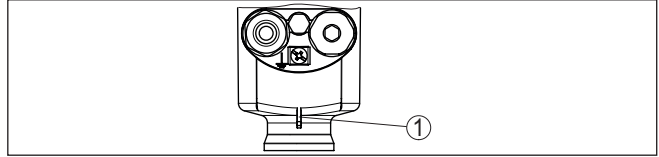

Fig. 1: Position of the polarisation

1 Nose for marking the direction of polarisation

Turning the housing changes the polarisation and thus also the effect of false echoes on the measured value.



**Note:**

Therefore, pay attention to the position of the polarisation when mounting or when making subsequent changes. Fix the housing to prevent a change in the metrological properties (see chapter "Housing features").

#### Mounting position - liquids

When mounting the device, keep a distance of at least 200 mm (7.874 in) from the vessel wall. If the device is installed in the center of dished or round vessel tops, multiple echoes can arise. However, these can be suppressed by an appropriate adjustment (see chapter "Setup").



**Note:**

If you cannot maintain this distance, you should carry out a false signal suppression during setup. This applies especially if buildup on the vessel wall is to be expected.<sup>2)</sup>

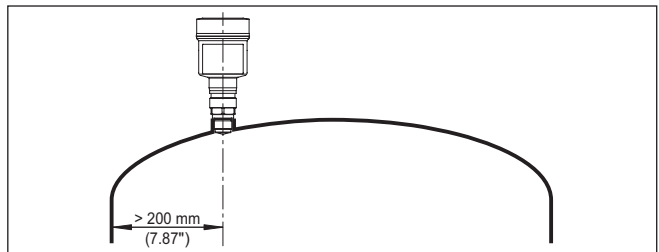

Fig. 2: Mounting of the radar sensor on round vessel tops

<sup>2)</sup> In this case, it is recommended to repeat the false signal suppression at a later time with existing buildup.

In vessels with conical bottom it can be advantageous to mount the device in the centre of the vessel, as measurement is then possible down to the bottom.

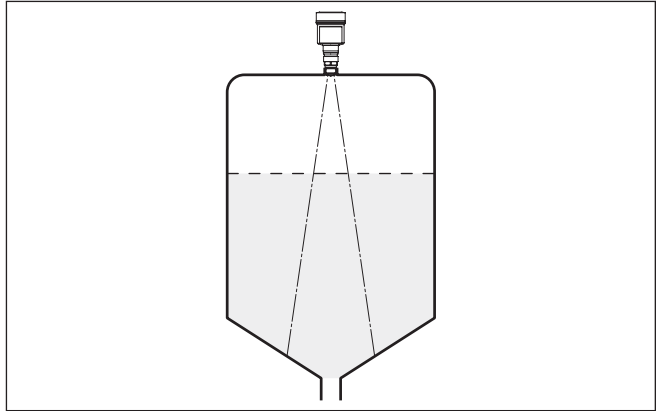

Fig. 3: Mounting of the radar sensor on vessels with conical bottom

#### Mounting position - bulk solids

Mount the instrument at least 200 mm (7.874 in) away from the vessel wall.

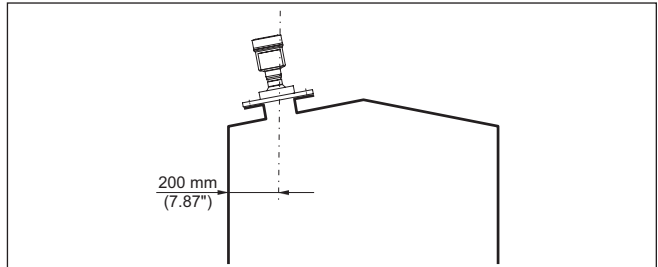

Fig. 4: Mounting the radar sensor on the vessel top



#### Note:

If you cannot maintain this distance, you should carry out a false signal suppression during setup. This applies especially if buildup on the vessel wall is to be expected.<sup>3)</sup>

<sup>3)</sup> In this case, it is recommended to repeat the false signal suppression at a later time with existing buildup.



## 5 Connecting to power supply

### 5.1 Connecting

**Connection technology**

The voltage supply and signal output are connected via the spring-loaded terminals in the housing.

Connection to the display and adjustment module or to the interface adapter is carried out via contact pins in the housing.

**Connection procedure**

Proceed as follows:

1. Unscrew the housing lid
2. If a display and adjustment module is installed, remove it by turning it slightly to the left
3. Loosen compression nut of the cable gland and remove blind plug
4. Remove approx. 10 cm (4 in) of the cable mantle, strip approx. 1 cm (0.4 in) of insulation from the ends of the individual wires
5. Insert the cable into the sensor through the cable entry



Fig. 5: Connection steps 5 and 6

6. Insert the wire ends into the terminals according to the wiring plan



**Note:**

Fixed conductors and flexible conductors with ferrules can be inserted directly into the terminal openings. In the case of flexible conductors for opening the terminals, use a screwdriver (3 mm blade width) to push the actuator lever away from the terminal opening. When released, the terminals are closed again.

7. Check the hold of the wires in the terminals by lightly pulling on them
8. Connect the shielding to the internal ground terminal, connect the external ground terminal to potential equalisation
9. Tighten the compression nut of the cable entry gland. The seal ring must completely encircle the cable
10. Reinsert the display and adjustment module, if one was installed
11. Screw the housing lid back on

The electrical connection is finished.

## 5.2 Wiring plan, double chamber housing



The following illustrations apply to the non-Ex as well as to the Ex-ia version.

### Electronics compartment

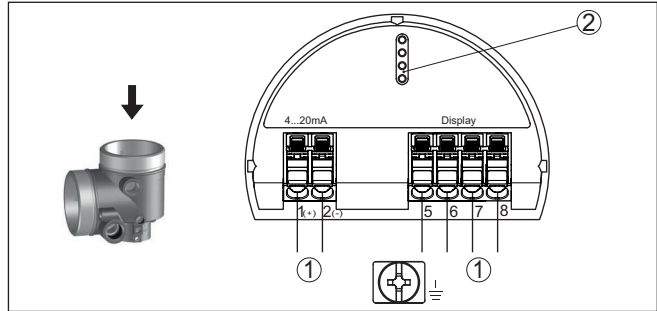

Fig. 6: Electronics compartment - double chamber housing

- 1 Internal connection to the connection compartment
- 2 For display and adjustment module or interface adapter

### Connection compartment

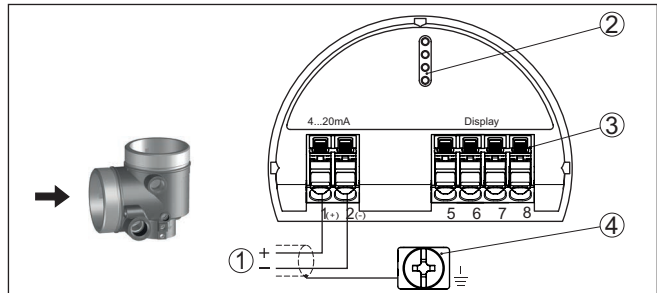

Fig. 7: Connection compartment - double chamber housing

- 1 Voltage supply, signal output
- 2 For display and adjustment module or interface adapter
- 3 For external display and adjustment unit
- 4 Ground terminal for connection of the cable screening

## 6 Set up with the display and adjustment module

### 6.1 Insert display and adjustment module

The display and adjustment module can be inserted into the sensor and removed again at any time. You can choose any one of four different positions - each displaced by 90°. It is not necessary to interrupt the power supply.

Proceed as follows:

1. Unscrew the housing lid
2. Place the display and adjustment module on the electronics in the desired position and turn it to the right until it snaps in.
3. Screw housing lid with inspection window tightly back on

Disassembly is carried out in reverse order.

The display and adjustment module is powered by the sensor, an additional connection is not necessary.

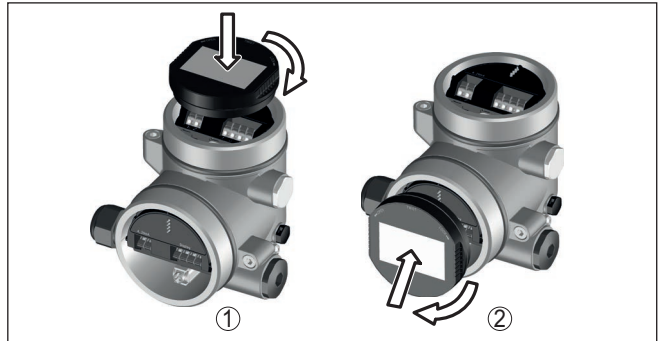

Fig. 8: Installing the display and adjustment module in the double chamber housing

- 1 In the electronics compartment
- 2 In the connection compartment



**Note:**

If you intend to retrofit the instrument with a display and adjustment module for continuous measured value indication, a higher lid with an inspection glass is required.

### 6.2 Parameterization

#### 6.2.1 Lock/Unlock adjustment

In this menu item you safeguard the sensor parameters against unauthorized or unintentional modifications.



**Information:**

The non-SIL version of the device is delivered without activated access protection. If necessary, the access protection can be activated and the device locked.



When the adjustment is blocked, only the following adjustment functions are possible without entering the device code:

- Select menu items and show data
- Read data from the sensor into the display and adjustment module



#### Caution:

When the adjustment is blocked, the adjustment via other systems is also blocked.

Releasing the sensor adjustment is also possible in any menu item by entering the device code.

### Lock/Unlock adjustment (SIL)

In this menu item you safeguard the sensor parameters against unauthorized or unintentional modifications.



#### Information:

The SIL version of the device is delivered in locket state.

#### Safe parameterization:

To avoid possible errors during parameterization in a non-safe user environment, a verification procedure is used that makes it possible to detect parameterization errors reliably. For this, safety-relevant parameters must be verified before they are stored in the device. In normal operating condition, the instrument is also locked against parameter changes through unauthorized access.



#### Information:

If the device code has been changed and forgotten, the enclosed information sheet "Access Protection" provides an emergency device code.

#### Character string comparison and serial number:

You first have to carry out the character string comparison. This is used to check the character representation.

Confirm if the two character strings are identical. The verification texts are provided in German and in the case of all other menu languages, in English.

Afterwards you confirm that the serial number of your instrument was carried over correctly. This is used to check device communication.

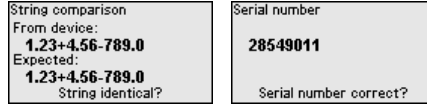

In the next step, the instrument checks the data of the measurement and decides by means of the evaluation results if a functions test is required. If a function test is necessary, the following message is displayed.

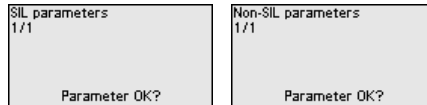

In this case, you have to carry out a function test.

**Function test:**

During a function test, you have to test the safety function of the instrument in the vessel with the original medium.



You can find the detailed sequence of the function test in chapter "Functional safety (SIL)" of the operating instructions.

**Verify parameter:**

All safety-relevant parameters must be verified after a change. After the function test, all modified, safety-relevant parameters will be listed. Confirm the modified values one after the other.

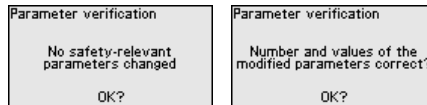

If the described process of parameter adjustment was run through completely and correctly, the instrument will be locked and hence ready for operation.



Otherwise the instrument remains in the released and hence unsafe condition.



**Note:**

When the adjustment is blocked, the adjustment via other systems is also blocked.

## 6.2.2 Setup

### Type of medium

This menu item allows you to adapt the sensor to the different measuring conditions of the media "Liquid" or "Bulk solid".

The corresponding application is selected in the following menu item "Application".

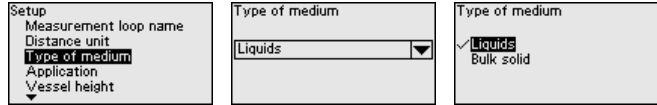

### Vessel height

Through this selection the operating range of the sensor is adapted to the vessel height. Hence the measurement reliability is increased considerably under different basic conditions.

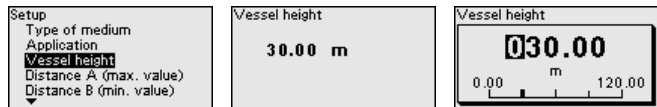

#### Note:

Regardless of this, the min. adjustment must also be carried out (see following section).

### Adjustment

Since the radar sensor is a distance measuring instrument, it is the distance from the sensor to the medium surface that is measured. To indicate the actual level, the measured distance must be assigned to a certain height percentage (min./max. adjustment).

During adjustment, enter the respective measuring distance when the vessel is full and empty (see the following examples):

#### Liquids:

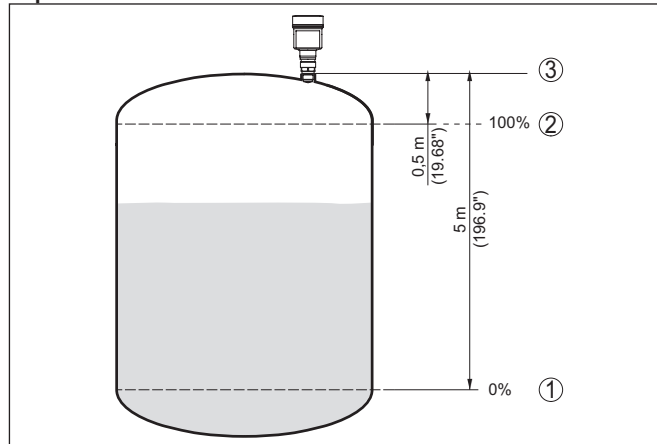

Fig. 9: Parameterisation example min./max. adjustment - liquids

- 1 Min. level = max. meas. distance (distance B)
- 2 Max. level = min. meas. distance (distance A)
- 3 Reference plane

**Bulk solids:**

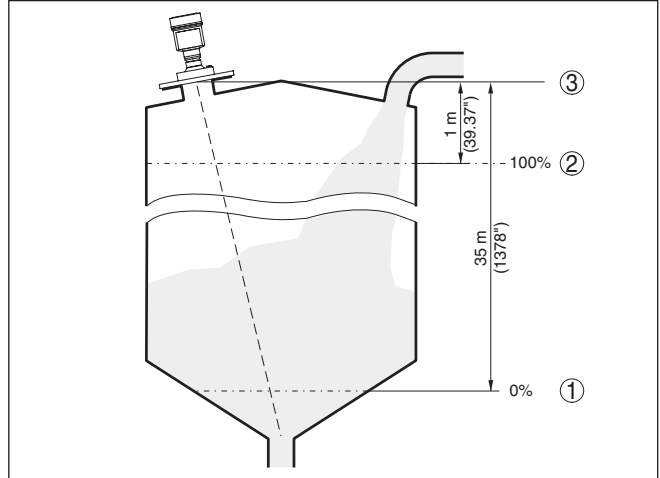

Fig. 10: Parameterisation example min./max. adjustment - bulk solids

- 1 Min. level = max. meas. distance (distance B)
- 2 Max. level = min. meas. distance (distance A)
- 3 Reference plane

If these values are not known, and adjustment can for example be carried out with the distances of 10 % and 90 %.

The starting point for these distance specifications is always the reference plane, e.g. the sealing surface of the thread or flange. Information on the reference plane can be found in the chapters "Mounting instructions" resp. "Technical data". The actual filling height is then calculated on the basis of these entries.

The actual product level during this adjustment is not important, because the min./max. adjustment is always carried out without changing the product level. These settings can be made ahead of time without the instrument having to be installed.

**Distance A (max. value)**

Proceed as follows:

1. Select with [->] the menu item Distance A (max. value) and confirm with [OK].

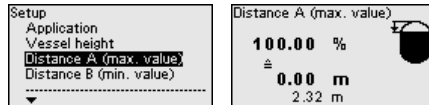

2. Edit the distance value with [OK] and set the cursor to the requested position with [->].
3. Adjust the requested distance value for 100 % with [+>] and store with [OK].

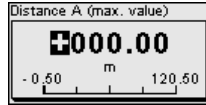

4. Move with **[ESC]** and **[->]** to the min. adjustment

### Distance B (min. value)

Proceed as follows:

1. Select with **[->]** the menu item "Distance B (min. value)" and confirm with **[OK]**.

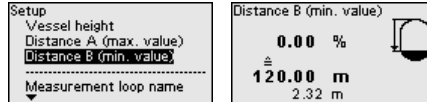

2. Edit the distance value with **[OK]** and set the cursor to the requested position with **[->]**.
3. Set the requested distance value for 0 % (e.g. distance from the sensor up to the vessel bottom) with **[+]** and save with **[OK]**. The cursor now jumps to the distance value.

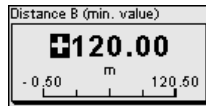

### 6.2.3 Extended settings

#### Mode

This menu item contains operational settings of the sensor.

#### Mode:

Country or region-specific settings for the radar signals are determined via the operating mode.

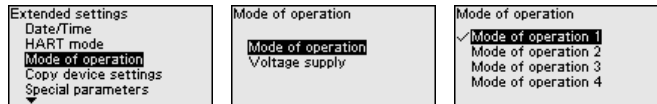

- Mode 1: EU, Albania, Andorra, Azerbaijan, Australia, Belarus, Bosnia and Herzegovina, Canada, Liechtenstein, Moldavia, Monaco, Montenegro, New Zealand, Northern Macedonia, Norway, San Marino, Saudi Arabia, Serbia, South-Africa, Switzerland, Turkey, Ukraine, United Kingdom, USA
- Mode of operation 2: Brazil, Japan, South Korea, Taiwan, Thailand
- Mode of operation 3: India, Malaysia
- Mode of operation 4: Russia, Kazakhstan



#### Note:

Depending on the operating mode, metrological properties of the device can change (see chapter "Technical data, input variable").

#### Voltage supply:

The power supply determines whether the sensor is in operation permanently or only in accordance with certain requirements.



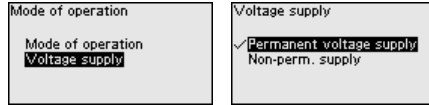

**Reset**

**6.2.4 Reset**

During a reset, parameter settings made by the user are reset to the values of the factory settings. You can find the values in chapter "Menu overview".

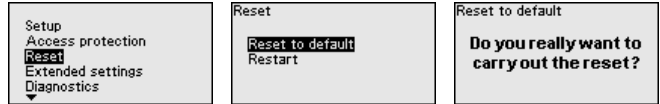

**Information:**

The language and Bluetooth access code are not reset, a currently running simulation however is aborted.

**Reset - Factory settings:**

- Restoring the factory and order-specific parameter settings
- Resetting a user-set measuring range to the recommended measuring range (see chapter "Technical data")
- Deleting a created false signal suppression, a user-programmable linearisation curve as well as the measured value and echo curve memory<sup>4)</sup>

**Reset - Restart:**

Is used to restart the device without switching off the operating voltage.



**Note:**

For the duration of the reset, the device changes its behaviour from the normal measuring operation. Therefore, observe the following for downstream systems:

- The current output outputs the set false signal
- The Asset-Management function outputs the message "Maintenance" aus

<sup>4)</sup> The event and parameter change memories are maintained.

## 7 Setup with smartphone/tablet (Bluetooth)

### 7.1 Preparations

#### System requirements

Make sure that your smartphone/tablet meets the following system requirements:

- Operating system: iOS 13 or newer
- Operating system: Android 5.1 or newer
- Bluetooth 4.0 LE or newer

Download the VEGA Tools app from the "Apple App Store", "Google Play Store" or "Baidu Store" to your smartphone or tablet.

Make sure that the Bluetooth function of the display and adjustment module is activated. For this, the switch on the bottom side must be set to "On".

Factory setting is "On".

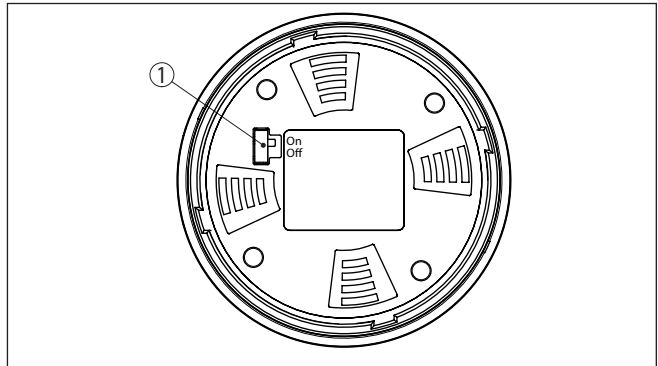

Fig. 11: Activate Bluetooth

- 1 Switch  
 On = Bluetooth active  
 Off = Bluetooth not active

### 7.2 Connecting

#### Connecting

Start the adjustment app and select the function "Setup". The smartphone/tablet searches automatically for Bluetooth-capable instruments in the area.

The message "Connecting ..." is displayed.

The devices found are listed and the search is automatically continued.

Select the requested instrument in the device list.

#### Authenticate

When establishing the connection for the first time, the operating tool and the sensor must authenticate each other. After the first correct authentication, each subsequent connection is made without a new authentication query.

**Enter Bluetooth access code**

For authentication, enter the 6-digit Bluetooth access code in the next menu window. You can find the code on the information sheet "*Pins and Codes*" in the device packaging.

For the very first connection, the adjustment unit and the sensor must authenticate each other.

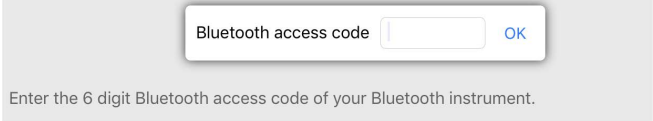

Fig. 12: Enter Bluetooth access code

**Note:**

If an incorrect code is entered, the code can only be entered again after a delay time. This time gets longer after each incorrect entry.

The message "*Waiting for authentication*" is displayed on the smartphone/tablet.

**Connected**

After connection, the sensor adjustment menu is displayed on the respective adjustment tool.

If the Bluetooth connection is interrupted, e.g. due to a too large distance between the two devices, this is displayed on the adjustment tool. The message disappears when the connection is restored.

**Change device code**

Parameter adjustment of the device is only possible if the parameter protection is deactivated or the adjustment released. When delivered, parameter protection is deactivated by default and can be activated at any time.

It is recommended to enter a personal 6-digit device code. To do this, go to menu "*Extended functions*", "*Access protection*", menu item "*Protection of the parameter adjustment*".

**7.3 Parameter adjustment****Enter parameters**

The sensor adjustment menu is divided into two areas, which are arranged next to each other or one below the other, depending on the adjustment tool.

- Navigation section
- Menu item display

The selected menu item can be recognized by the colour change.

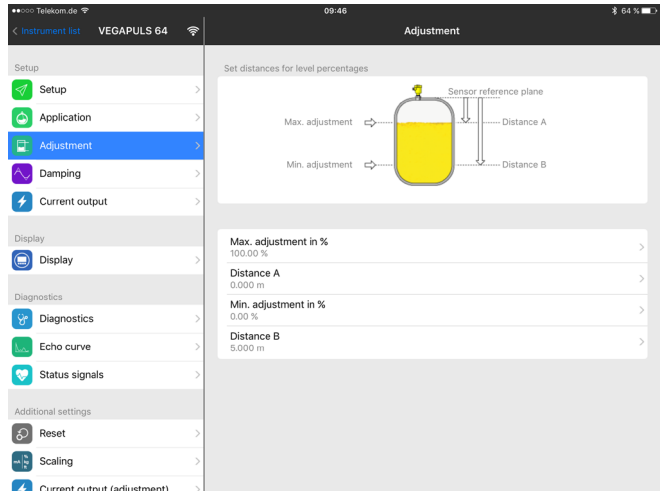

Fig. 13: Example of an app view - Setup measured values

Enter the requested parameters and confirm via the keyboard or the editing field. The settings are then active in the sensor.

Close the app to terminate connection.

## 8 Menu overview

### 8.1 Display and adjustment module

#### Setup

Menu item	Parameter	Selection	Default setting
Measurement loop name			Sensor
Distance unit	Distance unit	mm, m, in, ft	m
Type of medium	Type of medium	Liquid	Liquid <sup>5)</sup>
		Bulk solid	Bulk solid <sup>6)</sup>
Application	Application - liquid	Storage tank, agitator tank, dosing tank, standpipe, tank/collection basin, plastic tank (measurement through tank top), mobile plastic tank (IBC), level measurement in waters, flow measurement flume/overflow, pump station/pump shaft, combined sewer overflow, demonstration	Storage tank <sup>7)</sup>
	Application - bulk solid	Silo, bunker, crusher, heap, demonstration	Silo <sup>8)</sup>
Vessel height			Recommended meas. range, see chapter "Technical data"
Distance A (max. value)	Max. value		Max. adjustment 100 % corresponds to 0,000 m
Distance B (min. value)	Min. value		Min. adjustment 0 % corresponds to 120,000 m

#### Extended settings

Menu item	Parameter	Selection	Default setting
Temperature unit		°C, °F, K	°C
Damping	Integration time	0 ... 999 s	0 s

<sup>5)</sup> Plastic horn antenna, thread with integrated antenna system, flange with encapsulated antenna system

<sup>6)</sup> Flange with lens antenna

<sup>7)</sup> Plastic horn antenna, thread with integrated antenna system, flange with encapsulated antenna system

<sup>8)</sup> Flange with lens antenna

Menu item	Parameter	Selection	Default setting
Current output	Output value	Percent, linearized percent, filling height, distance, scaled, measurement reliability, electronics temperature, measuring rate, operating voltage	Percent
	Output characteristics	0 ... 100 % correspond to 4 ... 20 mA	0 ... 100 % correspond to 4 ... 20 mA
		0 ... 100 % correspond to 20 ... 4 mA	
	Current range	4 ... 20 mA	4 ... 20 mA
3.8 ... 20.5 mA			
Reaction when malfunctions occur	$\leq 3.6$ mA, $\geq 21$ mA, last valid measured value	$\leq 3.6$ mA	
Linearisation	Linearization type - liquid	Linear, cylindrical tank, spherical tank, Venturi, trapezoidal weir, rectangular weir, Palmer-Bowlus flume, V-Notch, triangular overfall	Linear
	Linearization type - bulk solids	Linear, conical bottom, pyramid bottom, sloping bottom	Linear
	Intermediate height "h"		
Scaling	Scaling size	Scaling size (dimensionless, mass, volume, height, pressure, flow, others)	Dimensionless
		Scaling unit (unit selection depending on scaling size, user-defined)	-
	Scaling format	#, #.#, #.##, #.###, #.####, #.#####	#
	Scaling	Scaling	100 % correspond to 0 % correspond to
Indication	Menu language	German, English, French, Spanish, Portuguese, Italian, Dutch, Russian, Chinese, Japanese, Turkish, Polish, Czech	Language is set with the first operation.
	Presentation	One measured value, measured value and bargraph, two measured values	One measured value
	Displayed values 1, 2	Percent, linearized percent, filling height, distance, scaled, measurement reliability, electronics temperature, current output, current output 2	Percent
	Backlight	On, Off	On
False signal suppression	False signal suppression	Create new, expand, delete all	-
Date/Time	Date/Time	Date	Actual date
		Format: 24 h, 12 h	24 h
		Time	Actual time
HART mode	HART address	0 ... 63	0
	Output mode	Analogue current output with HART, fix current (4 mA) with HART	Analogue current output with HART

Menu item	Parameter	Selection	Default setting
Mode	Mode	Mode 1: EU, Albania, Andorra, Azerbaijan, Australia, Belarus, Bosnia and Herzegovina, Canada, Liechtenstein, Moldavia, Monaco, Montenegro, Morocco, New Zealand, Northern Macedonia, Norway, San Marino, Saudi Arabia, Serbia, South-Africa, Switzerland, Turkey, Ukraine, United Kingdom, USA Mode of operation 2: Brazil, Japan, South Korea, Taiwan, Thailand Mode of operation 3: India, Malaysia Mode 4: Russia	Mode 1
	Voltage supply	Permanent voltage supply	Permanent voltage supply
		Not permanent voltage supply	
Copy instrument settings		Read from sensor, store in sensor	-
Special parameters	See separate menu overview at the end of the chapter "Menu overview" of the operating instructions.		

**Reset**

Menu item	Parameter	Selection	Default setting
Reset	Reset	Reset to factory settings, Restart	-

## 9 Supplement

### 9.1 Technical data

#### Note for approved instruments

The technical data in the respective safety instructions which are included in delivery are valid for approved instruments (e.g. with Ex approval). These data can differ from the data listed herein, for example regarding the process conditions or the voltage supply.

All approval documents can be downloaded from our homepage.

#### Electromechanical data - version IP66/IP67 and IP66/IP68 (0.2 bar)

Options of the cable entry

- Cable entry M20 x 1.5; ½ NPT
- Cable gland M20 x 1.5; ½ NPT (cable ø see below table)
- Blind plug M20 x 1.5; ½ NPT
- Closing cap ½ NPT

Material cable gland	Material seal insert	Cable diameter				
		4.5 ... 8.5 mm	5 ... 9 mm	6 ... 12 mm	7 ... 12 mm	10 ... 14 mm
PA	NBR	-	√	√	-	√
Brass, nickel-plated	NBR	√	√	√	-	-
Stainless steel	NBR	-	√	√	-	√

Wire cross-section (spring-loaded terminals)

- Massive wire, stranded wire 0.2 ... 2.5 mm<sup>2</sup> (AWG 24 ... 14)
- Stranded wire with end sleeve 0.2 ... 1.5 mm<sup>2</sup> (AWG 24 ... 16)

#### Integrated overvoltage protection

Highest continuous operating voltage	35 V DC
Max. permissible input current	500 mA
DC response voltage	600 V ±20 % (100 V/s)
Impulse response voltage	
– 100 V/μs	850 V
– 1000 V/μs	1100 V
Discharge current	< 10 kA (8/20 μs)
Functional safety	SIL non-reactive

#### Voltage supply, sensor

Operating voltage U <sub>B</sub>	12 ... 35 V DC
Operating voltage U <sub>B</sub> with lighting switched on	18 ... 35 V DC
Reverse voltage protection	Integrated



## Permissible residual ripple

- for  $12\text{ V} < U_B < 18\text{ V}$   $\leq 0.7 V_{\text{eff}}$  (16 ... 400 Hz)
- for  $18\text{ V} < U_B < 35\text{ V}$   $\leq 1 V_{\text{eff}}$  (16 ... 400 Hz)

## Load resistor

- Calculation  $(U_B - U_{\text{min}})/0.022\text{ A}$
- Example -  $U_B = 24\text{ V DC}$   $(24\text{ V} - 12\text{ V})/0.022\text{ A} = 545\ \Omega$

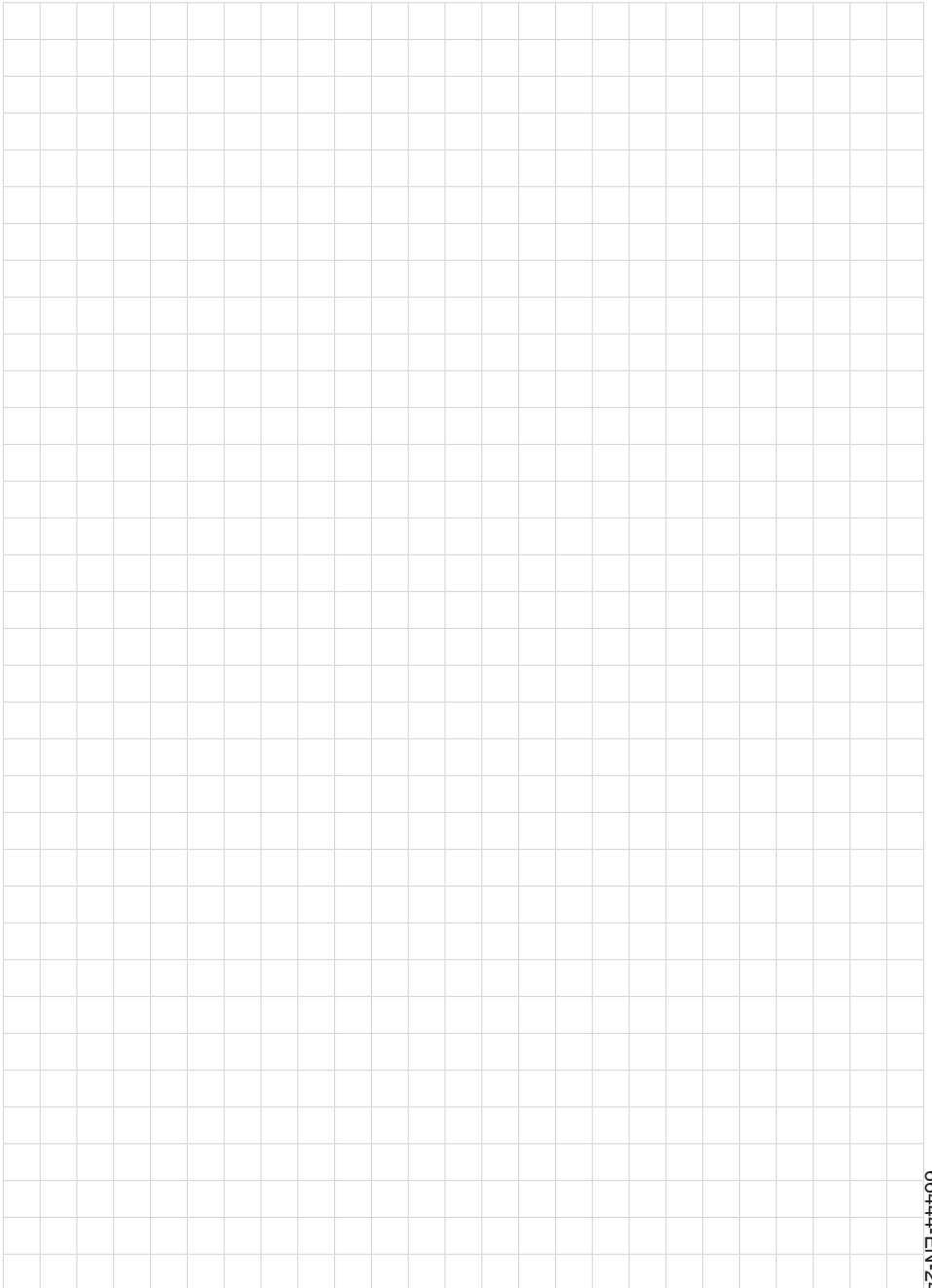

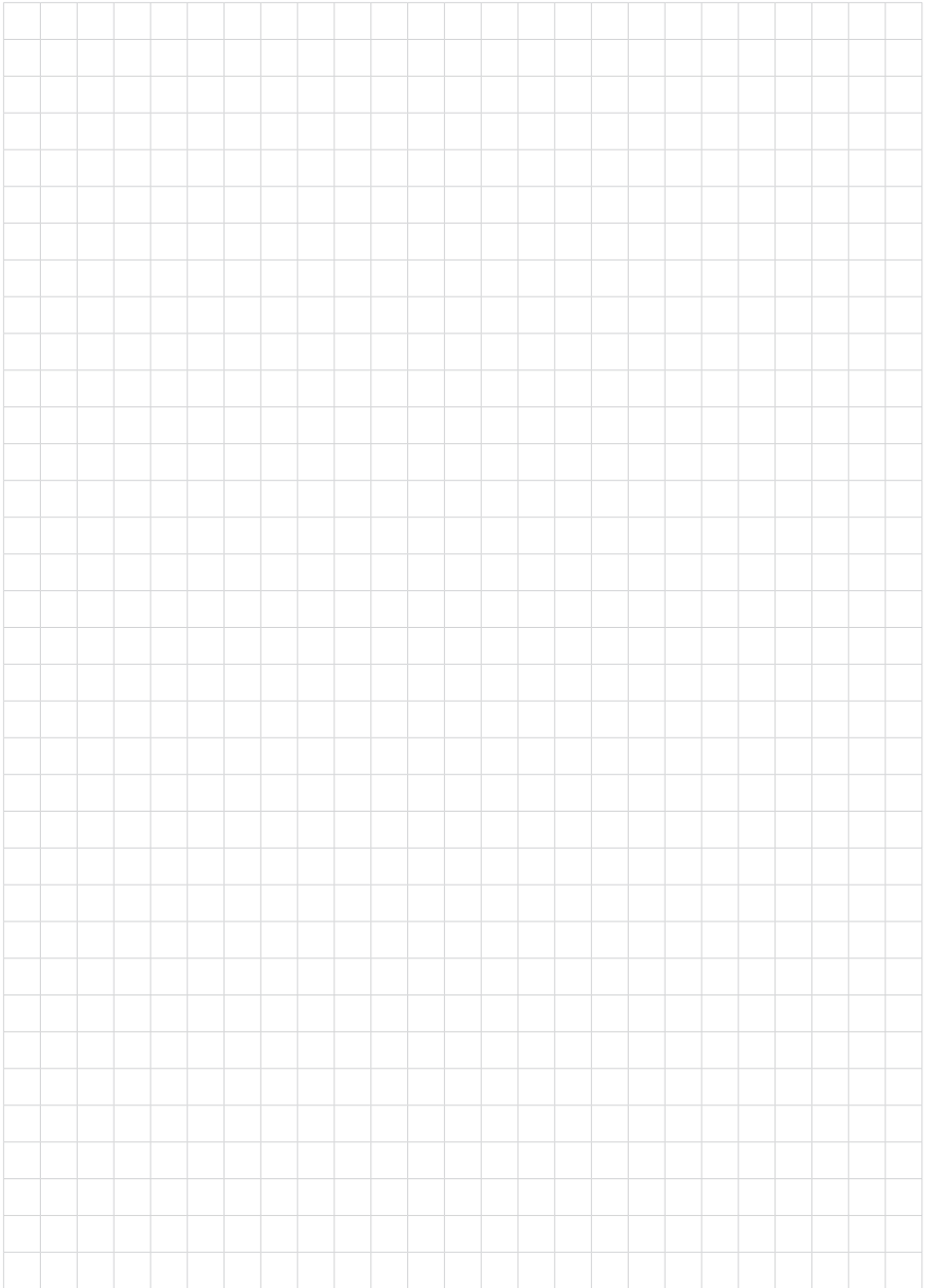

Printing date:

**VEGA**

All statements concerning scope of delivery, application, practical use and operating conditions of the sensors and processing systems correspond to the information available at the time of printing.

Subject to change without prior notice

© VEGA Grieshaber KG, Schiltach/Germany 2024



66444-EN-240311

VEGA Grieshaber KG  
Am Hohenstein 113  
77761 Schiltach  
Germany

Phone +49 7836 50-0  
E-mail: [info.de@vega.com](mailto:info.de@vega.com)  
[www.vega.com](http://www.vega.com)