

Quick setup guide

Radiometric sensor for continuous level and interface measurement

FIBERTRAC 32

Four-wire 4 ... 20 mA/HART

With SIL qualification



Document ID: 62073



VEGA

Contents

1	For your safety	3
1.1	Authorised personnel	3
1.2	Appropriate use.....	3
1.3	Warning about incorrect use.....	3
1.4	General safety instructions	3
1.5	Conformity.....	3
1.6	NAMUR recommendations	4
1.7	Installation and operation in the USA and Canada	4
1.8	Environmental instructions	4
2	Product description	5
2.1	Configuration.....	5
2.2	Principle of operation.....	6
2.3	System limitations	6
2.4	Corresponding source container	7
3	Mounting.....	9
3.1	General instructions	9
3.2	Mounting instructions	10
4	Connecting to power supply.....	14
4.1	Preparing the connection	14
4.2	Connection - Level measurement.....	16
4.3	Connection - Level detection	18
4.4	Connection - Summation.....	20
5	Functional safety (SIL)	22
5.1	Objective	22
5.2	SIL qualification.....	22
5.3	Application area	22
5.4	Safety concept of the parameterization	23
6	Set up with the display and adjustment module	25
6.1	Insert display and adjustment module	25
6.2	Parameter adjustment - Summation Secondary.....	25
7	Supplement	28
7.1	Technical data	28



Information:

This quick setup guide enables quick setup and commissioning of your instrument.

You can find supplementary information in the corresponding, more detailed Operating Instructions Manual as well as the Safety Manual that comes with instruments with SIL qualification. These manuals are available on our homepage.

**Operating instructions FIBERTRAC 32, four-wire 4 ... 20 mA/
HART, with SIL qualification: Document-ID 43905**

Editing status of the quick setup guide: 2022-11-22

1 For your safety

1.1 Authorised personnel

All operations described in this documentation must be carried out only by trained, qualified personnel authorised by the plant operator.

During work on and with the device, the required personal protective equipment must always be worn.

1.2 Appropriate use

FIBERTRAC 32 is a sensor for continuous level measurement.

You can find detailed information about the area of application in chapter " *Product description*".

Operational reliability is ensured only if the instrument is properly used according to the specifications in the operating instructions manual as well as possible supplementary instructions.

1.3 Warning about incorrect use

Inappropriate or incorrect use of this product can give rise to application-specific hazards, e.g. vessel overflow through incorrect mounting or adjustment. Damage to property and persons or environmental contamination can result. Also, the protective characteristics of the instrument can be impaired.

1.4 General safety instructions

This is a state-of-the-art instrument complying with IEC 61508 and all prevailing regulations and directives. The instrument must only be operated in a technically flawless and reliable condition. The operator is responsible for the trouble-free operation of the instrument. When measuring aggressive or corrosive media that can cause a dangerous situation if the instrument malfunctions, the operator has to implement suitable measures to make sure the instrument is functioning properly.

The safety instructions in this operating instructions manual, the corresponding Safety Manual, the national installation standards as well as the valid safety regulations and accident prevention rules must be observed by the user.

For safety and warranty reasons, any invasive work on the device beyond that described in the operating instructions manual may be carried out only by personnel authorised by the manufacturer. Arbitrary conversions or modifications are explicitly forbidden. For safety reasons, only the accessory specified by the manufacturer must be used.

To avoid any danger, the safety approval markings and safety tips on the device must also be observed.

1.5 Conformity

The device complies with the legal requirements of the applicable country-specific directives or technical regulations. We confirm conformity with the corresponding labelling.

The corresponding conformity declarations can be found on our homepage.

Electromagnetic compatibility

Instruments in four-wire or Ex d ia version are designed for use in an industrial environment. Nevertheless, electromagnetic interference from electrical conductors and radiated emissions must be taken into account, as is usual with class A instruments according to EN 61326-1. If the instrument is used in a different environment, the electromagnetic compatibility to other instruments must be ensured by suitable measures.

1.6 NAMUR recommendations

NAMUR is the automation technology user association in the process industry in Germany. The published NAMUR recommendations are accepted as the standard in field instrumentation.

The device fulfils the requirements of the following NAMUR recommendations:

- NE 21 – Electromagnetic compatibility of equipment
- NE 43 – Signal level for fault information from measuring transducers
- NE 53 – Compatibility of field devices and display/adjustment components
- NE 107 – Self-monitoring and diagnosis of field devices

For further information see www.namur.de.

1.7 Installation and operation in the USA and Canada

This information is only valid for USA and Canada. Hence the following text is only available in the English language.

Installations in the US shall comply with the relevant requirements of the National Electrical Code (ANSI/NFPA 70).

Installations in Canada shall comply with the relevant requirements of the Canadian Electrical Code.

1.8 Environmental instructions

Protection of the environment is one of our most important duties. That is why we have introduced an environment management system with the goal of continuously improving company environmental protection. The environment management system is certified according to DIN EN ISO 14001.

Please help us fulfil this obligation by observing the environmental instructions in this manual:

- Chapter " *Packaging, transport and storage* "
- Chapter " *Disposal* "

2 Product description

2.1 Configuration

Type label

The type label contains the most important data for identification and use of the instrument:

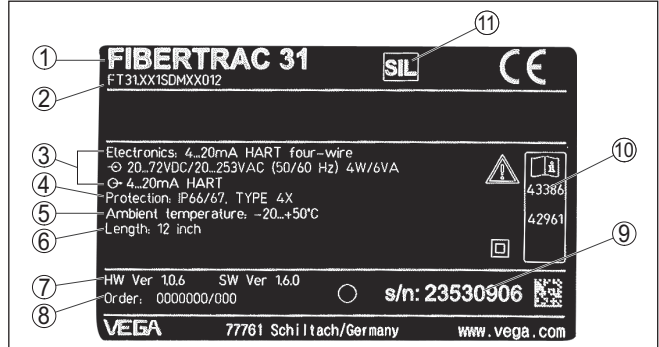

Fig. 1: Layout of the type label (example)

- 1 Instrument type
- 2 Product code
- 3 Electronics
- 4 Protection rating
- 5 Ambient temperature
- 6 Measuring range
- 7 Hardware and software version
- 8 Order number
- 9 Serial number of the instrument
- 10 ID numbers, instrument documentation
- 11 SIL identification

Stainless steel type label

Adhesive labels can peel off or become illegible under harsh ambient conditions or the influence of aggressive materials.

The optional stainless steel type label is screwed tightly to the housing and the labelling is permanently resistant.

The stainless steel type label cannot be retrofitted.

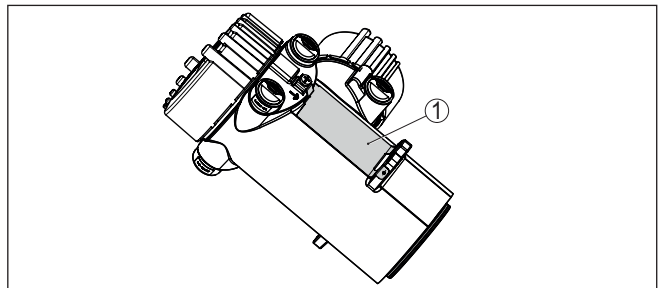

Fig. 2: Position of the stainless steel type label

- 1 Stainless steel type label

Serial number - Instrument search

The type label contains the serial number of the instrument. With it you can find the following instrument data on our homepage:

- Product code (HTML)
- Delivery date (HTML)
- Order-specific instrument features (HTML)
- Operating instructions and quick setup guide at the time of shipment (PDF)
- Test certificate (PDF) - optional

Move to "www.vega.com" and enter in the search field the serial number of your instrument.

Alternatively, you can access the data via your smartphone:

- Download the VEGA Tools app from the "*Apple App Store*" or the "*Google Play Store*"
- Scan the QR-code on the type label of the device or
- Enter the serial number manually in the app

2.2 Principle of operation**Application area**

The instrument is suitable for applications in liquids and bulk solids in vessels under difficult process conditions. There are application possibilities in nearly all areas of industry.

The level is detected contactlessly right through the vessel wall. Neither a process fitting nor a vessel opening are required. The instrument is thus ideal for retro installation.

Functional principle

In radiometric measurement, a Caesium-137 or Cobalt-60 isotope emits focussed gamma rays that are attenuated when penetrating the vessel wall and the medium. The PVT detector on the opposite side of the tank receives the radiation, whose strength is dependent on the level. The measuring principle has proven to be very reliable in conjunction with extreme process conditions because it measures contactlessly from outside through the vessel wall. The measuring system ensures maximum safety, reliability and plant availability, independently of the medium and its properties.

2.3 System limitations

There are several measuring principle-specific factors which can influence the measuring result. Keep these factors in mind in order to fully utilize the capabilities of the instrument with respect to measurement reliability and non-repeatability.

Activity of the source

The implemented radioactive isotope and its activity must be selected according to the properties of the vessel and the medium. The necessary radioactive activity must be calculated on the basis of the plant data.

To this end, make use of our planning service for an optimum layout of the measurement and selection of the isotope. This applies particularly to SIL applications.

Due to the physical properties of the radioactive radiation, the pulse rate is subject to slight fluctuations. Set a suitable damping level to get a stable measured value.

Non-linearity of the process value

The relation between level and the pulse rate measured by the sensor is not linear.

Set up a linearization table to get a linear level signal. For precise measurement results, make sure when setting up the linearization table that the actual filling height of the measuring points is entered as exactly as possible.

External radiation

External radiation sources can influence the measured value (e.g. welding joint tests). In safety-relevant applications, the safety function must be treated as unreliable as long as the external radiation occurs. If necessary, you must take measures to maintain the safety function.

Span

Make sure during the planning that for the planned application, a possibly large different of the pulse rate with empty and full vessel is reached. This applies mainly for products with low density or in vessels with extremely small diameter.

2.4 Corresponding source container

A radioactive isotope in a suitable source holder is the prerequisite for a radiometric measurement setup.

The handling of radioactive substances is regulated by law. The radiation protection rules of the country in which the system is operated apply first and foremost.

In Germany, for example, the current radiation protection ordinance (StrlSchV) based on the Atomic Energy Law (AtG) applies.

The following points are important for measurement with radiometric methods:

Handling permit

A handling permit is required for operation of a system using gamma rays. This permit is issued by the respective government office or the responsible authority (in Germany, for example, offices for environmental protection, trade supervisory boards, etc.)

You can find further instructions in the operating instructions manual of the source container.

General instructions for radiation protection

When handling radioactive sources, unnecessary radiation exposure must be avoided. An unavoidable radiation exposure must be kept as low as possible. Take note of the following three important measures:

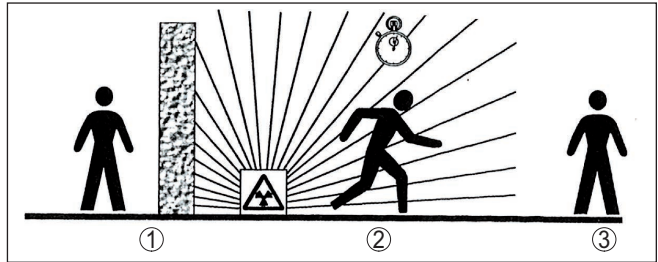

Fig. 3: Measures for protection against radioactive radiation

- 1 Shielding
- 2 Time
- 3 Distance

Shielding: Provide good shielding between the source and yourself as well as all other persons. Special source containers (e.g. VEGASOURCE) as well as all materials with high density (e.g. lead, iron, concrete, etc.) provide effective shielding.

Time: Stay as short a time as possible in radiation exposed areas.

Distance: Your distance to the source should be as large as possible. The local dose rate of the radiation decreases in proportion to the square of the distance to the radiation source.

Radiation safety officer

The plant operator must appoint a radiation safety officer with the necessary expert knowledge. He is responsible for ensuring that the radiation protection ordinance is complied with and for implementing all radiation protection measures.

Control area

Control areas are areas in which the local dose rate exceeds a certain value. Only persons who undergo official dose monitoring are allowed into these control areas. You can find the respectively valid limit values for control areas in the guideline of the respective authority (in Germany, for example, the radiation protection ordinance).

We are at your disposal for further information concerning radiation protection and regulations in other countries.

3 Mounting

3.1 General instructions

Switch off source

The source container is part of the measuring system. In case the source container is already equipped with an active isotope, the source container must be locked before mounting.

**Danger:**

Before mounting; make sure that the source is securely closed. Use a padlock to secure the source container in the closed condition and prevent it from being inadvertently opened.

Protection against moisture

Protect your instrument against moisture ingress through the following measures:

- Use a suitable connection cable (see chapter " *Connecting to power supply* ")
- Tighten the cable gland or plug connector
- Lead the connection cable downward in front of the cable entry or plug connector

This applies mainly to outdoor installations, in areas where high humidity is expected (e.g. through cleaning processes) and on cooled or heated vessels.

**Note:**

Make sure that during installation or maintenance no moisture or dirt can get inside the instrument.

To maintain the housing protection, make sure that the housing lid is closed during operation and locked, if necessary.

Process conditions

**Note:**

For safety reasons, the instrument must only be operated within the permissible process conditions. You can find detailed information on the process conditions in chapter " *Technical data* " of the operating instructions or on the type label.

Hence make sure before mounting that all parts of the instrument exposed to the process are suitable for the existing process conditions.

These are mainly:

- Active measuring component
- Process fitting
- Process seal

Process conditions in particular are:

- Process pressure
- Process temperature
- Chemical properties of the medium
- Abrasion and mechanical influences

Cable glands**Metric threads**

In the case of instrument housings with metric thread, the cable glands are screwed in at the factory. They are sealed with plastic plugs as transport protection.

You have to remove these plugs before electrical connection.

NPT thread

In the case of instrument housings with self-sealing NPT threads, it is not possible to have the cable entries screwed in at the factory. The free openings for the cable glands are therefore covered with red dust protection caps as transport protection.

Prior to setup you have to replace these protective caps with approved cable glands or close the openings with suitable blind plugs.

The suitable cable glands and blind plugs come with the instrument.

3.2 Mounting instructions**Installation position****Note:**

During the planning, our specialists will analyse the conditions of the measurement loop to dimension the isotope accordingly.

You get a "Source Sizing" document specifying the required source activity and containing all relevant mounting information for your measuring point.

You must follow the instructions in this "Source Sizing" document in addition to the following mounting instructions.

The following mounting information is applicable as long as there is nothing else specified in the "Source Sizing" document.

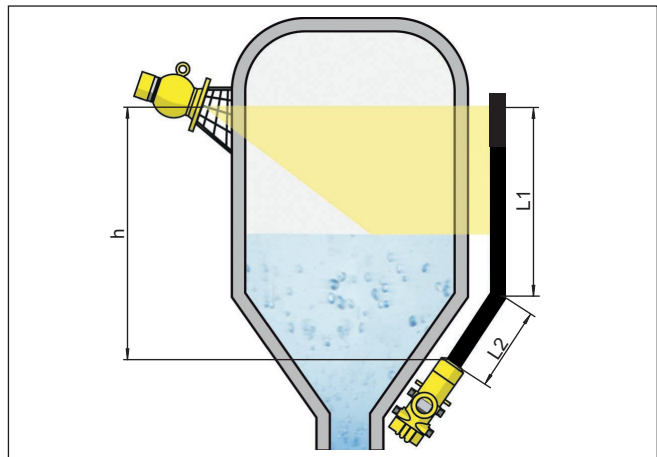

Fig. 4: Level measurement in a storage tank

h Measuring range

L Measurement length (*L1*, *L2*)

You can find information on protective barriers and the mounting of the corresponding source container in the operating instructions manual of the source container, e.g. VEGASOURCE.

You can mount the FIBERTRAC 32 with the housing head upward or downward. When the housing head is mounted downward, the housing itself is more easily accessible.

Fasten the sensor in such a way that it cannot fall out of the holder. If necessary, provide the sensor with a support from below.

Direct the exit angle of the source container to the FIBERTRAC 32.

Mount the source container as close as possible to the vessel. If there are gaps, secure the area with a safety fence and protective grating so that no one can reach into the dangerous area.

Mounting clamps

You can mount the sensor on your vessel with the enclosed mounting clamps. A number of mounting clamps come with the FIBERTRAC 32 depending on the length of the sensor.

Use a mounting clamp approx. every 450 mm (17.72 in). During mounting, adjust the distances between the attached mounting clips.

Take note of the minimum bending radius of the sensor, which is 305 mm (12 in).

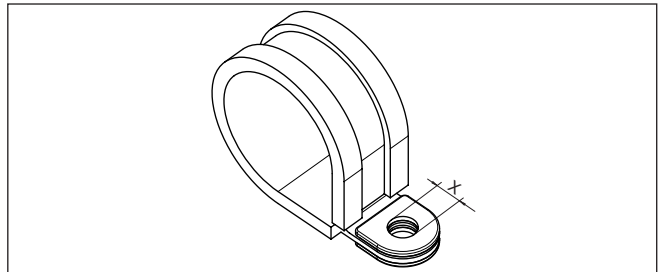

Fig. 5: Mounting clamp

x Hole for screw M8

→ Determine the exact mounting position of one or several mounting clamps and mark the holes.

Align the mounting positions exactly and average the distances between the enclosed mounting clamps.

Drill appropriate holes (max. M12) for fastening the mounting clamps.



Note:

The mounting clamps do not come with fastening screws. Use fastening elements that are appropriate for the situation in your plant.

Summation

To measure the level in very high vessels, multiple instruments can be cascaded.

Cascading means that two or several instruments are connected which can together cover a longer measuring range.

You can find the exact number of Secondaries in the " Safety Manual".

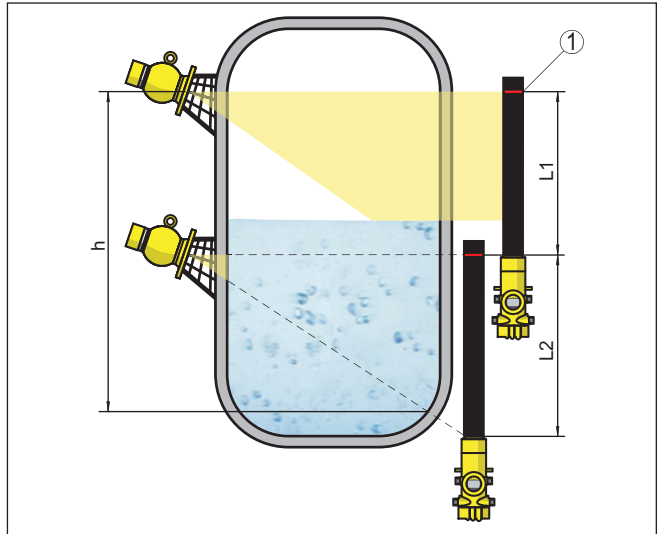

Fig. 6: Installation position - cascading arrangement

h Summed measuring range

L Measurement length (L_1 , L_2)

1 Red marking line for designating the measuring range

Here, one instrument acts as a Primary and all other instruments operate as Summation Secondary. The pulse rates of all instruments are summed in the Primary instrument and converted into a common signal.

If several sensors are cascaded, the measuring ranges of the individual detectors must directly join each other. The detectors must also slightly overlap.

Make sure that the red marking lines directly join the measuring range of the next FIBERTRAC 32.

Mount the FIBERTRAC 32 in such a way that the detector hose is directly in the radiated area of the source container. Mount the FIBERTRAC 32 preferably side by side and make sure that no detector hose is hidden by another sensor.

Vessel with heat insulation

On vessels with temperature insulation, the sensor and the source container should be preferably mounted outside of the tank insulation.

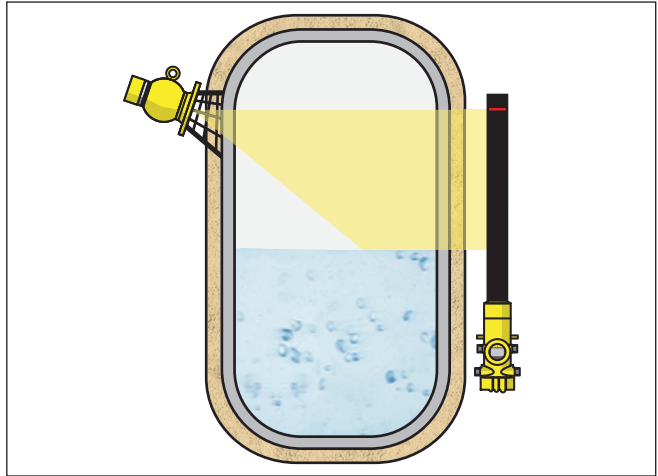

Fig. 7: Level measurement on a heated vessel with heat insulation

If this is not possible, make sure that there is a sufficiently large cut-out in the tank insulation for mounting the sensor and the source container. Make sure that the max. ambient temperature of the sensor is not exceeded.

Protection against heat

If the max. ambient temperature is exceeded, you must take suitable measures to protect the instrument against overheating.

You can protect the instrument by providing a suitable insulation against the heat or mounting the instrument further away from the heat source.

Make sure these measures are taken into account already in the planning stage. If you want to carry out such measures later on, contact our specialists to ensure that the accuracy of the application is not impaired.

If these measures are not sufficient to maintain the max. ambient temperature, you could consider using the water or air cooling system we offer for FIBERTRAC 32.

The cooling system must also be included in the calculations for the measuring point. Contact our specialists regarding the dimensioning of the cooling.

4 Connecting to power supply

4.1 Preparing the connection

Safety instructions

Always keep in mind the following safety instructions:

- The electrical connection must only be carried out by trained, qualified personnel authorised by the plant operator.
- If overvoltage surges are expected, overvoltage arresters should be installed.



Warning:

Only connect or disconnect in de-energized state.



Note:

Install a disconnecting device for the instrument which is easy to access. The disconnecting device must be marked for the instrument (IEC/EN 61010).

Connection technology

The voltage supply and signal output are connected via the spring-loaded terminals in the housing.

Connection to the display and adjustment module or to the interface adapter is carried out via contact pins in the housing.

Connection procedure

Proceed as follows:

The procedure applies to instruments without explosion protection.

1. Unscrew the big housing cover
2. Loosen compression nut of the cable gland and remove blind plug
3. Remove approx. 10 cm (4 in) of the cable mantle, strip approx. 1 cm (0.4 in) of insulation from the ends of the individual wires
4. Insert the cable into the sensor through the cable entry

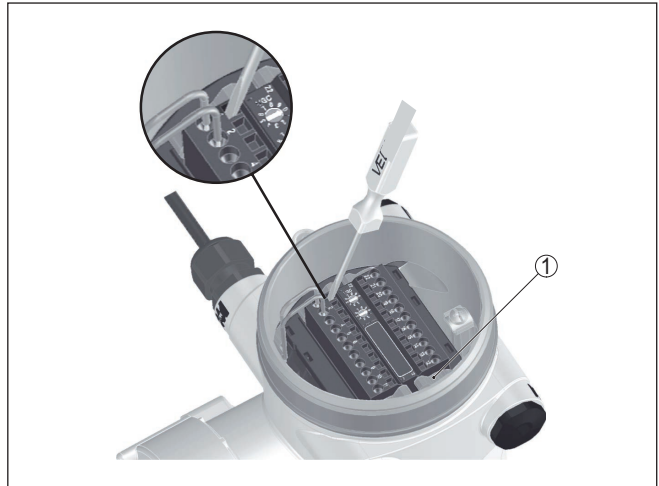

Fig. 8: Connection steps 4 and 5

1 Locking of the terminal blocks

5. Insert a small slotted screwdriver firmly into the rectangular lock openings of the respective connection terminal
6. Insert the wire ends into the round openings of the terminals according to the wiring plan

i **Information:**

Solid cores as well as flexible cores with cable end sleeves are inserted directly into the terminal openings. In case of flexible cores without end sleeves, press the rectangular lock opening with a small screwdriver; the terminal opening is freed. When the screwdriver is released, the terminal opening closes again.

7. Check the hold of the wires in the terminals by lightly pulling on them
To loosen a line, insert a small slotted screwdriver firmly into the rectangular lock opening according to the illustration
8. Connect the shielding to the internal ground terminal, connect the external ground terminal to potential equalisation
9. Tighten the compression nut of the cable entry gland. The seal ring must completely encircle the cable
10. Screw the housing lid back on

The electrical connection is finished.

i **Information:**

The terminal blocks are pluggable and can be detached from the electronics. To do this, loosen the two lateral locking levers of the terminal block with a small screwdriver. When loosening the locking, the terminal block is automatically squeezed out. It must snap in place when re-inserted.

4.2 Connection - Level measurement

Non-Ex instruments and instruments with non-intrinsically safe current output

Electronics and connection compartment - Non-Ex instruments and instruments with non-intrinsically safe current output

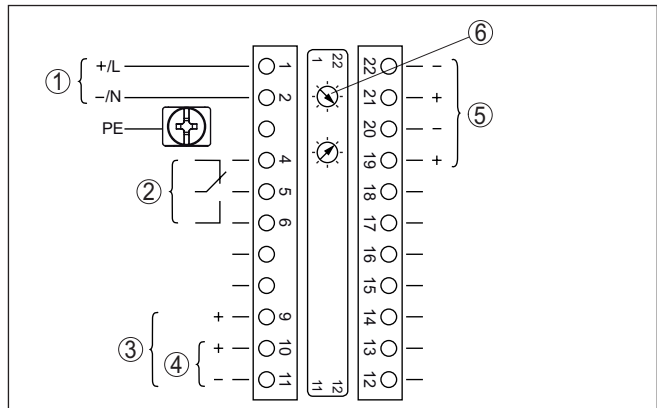

Fig. 9: Electronics and connection compartment with non-Ex instruments and instruments with non-intrinsically safe current output

- 1 Voltage supply
- 2 Relay output
- 3 Signal output 4 ... 20 mA/HART active
- 4 Signal output 4 ... 20 mA/HART passive
- 5 Interface for sensor-sensor communication (MGC)
- 6 Setting the bus address for sensor-sensor communication (MGC)¹⁾

Adjustment and connection compartment - Non-Ex instruments and instruments with non-intrinsically safe current output

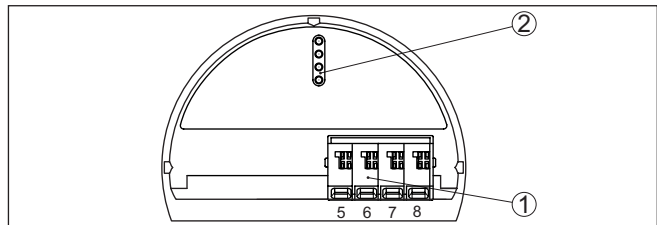

Fig. 10: Adjustment and connection compartment with non-Ex instruments and instruments with non-intrinsically safe current output

- 1 Terminals for the external display and adjustment unit
- 2 Contact pins for the display and adjustment module or interface adapter

Instruments with intrinsically safe current output



You can find detailed information on the explosion-protected versions (Ex ia, Ex d) in the Ex-specific safety instructions. These safety instructions are part of the scope of delivery and come with the Ex-approved instruments.

¹⁾ MGC = Multi Gauge Communication

Electronics and connection compartment - Instruments with intrinsically safe current output

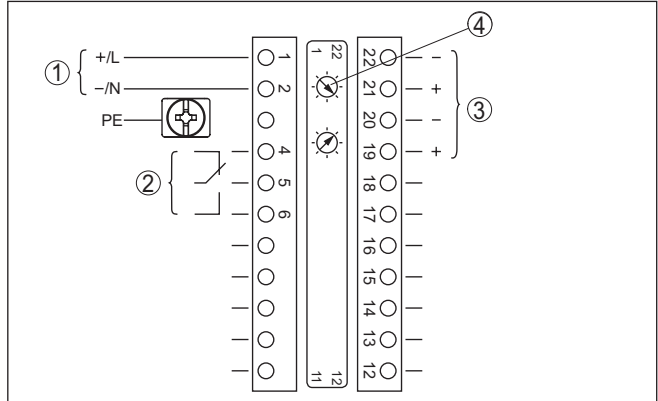

Fig. 11: Electronics and connection compartment (Ex d) with instruments with intrinsically safe current output

- 1 Voltage supply
- 2 Relay output
- 3 Interface for sensor-sensor communication (MGC)
- 4 Setting the bus address for sensor-sensor communication (MGC)²⁾

Adjustment and connection compartment - Instruments with intrinsically safe current output

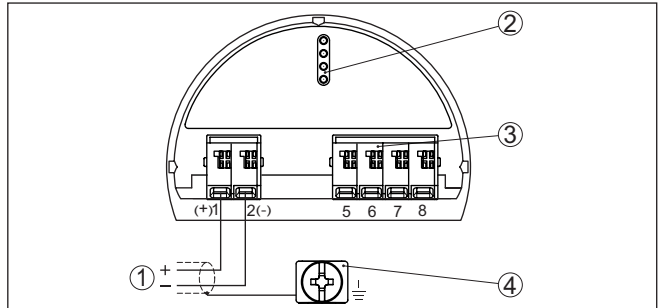

Fig. 12: Adjustment and connection compartment (Ex ia) with instruments with intrinsically safe current output

- 1 Terminals for intrinsically safe signal output 4 ... 20 mA/HART (active)
- 2 Contact pins for the display and adjustment module or interface adapter
- 3 Terminals for the external display and adjustment unit
- 4 Ground terminal

²⁾ MGC = Multi Gauge Communication

4.3 Connection - Level detection

Non-Ex instruments and instruments with non-intrinsically safe current output

Electronics and connection compartment - Non-Ex instruments and instruments with non-intrinsically safe current output

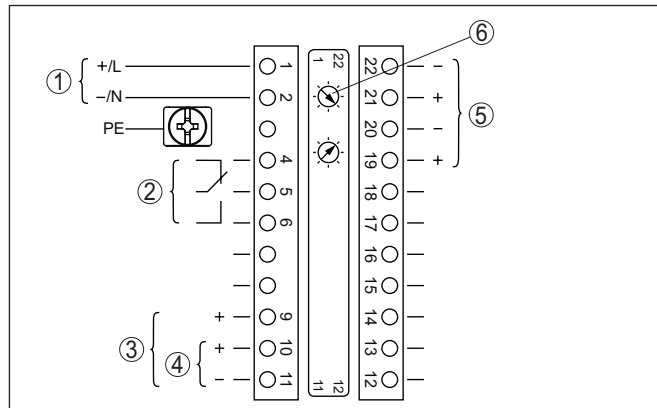

Fig. 13: Electronics and connection compartment with non-Ex instruments and instruments with non-intrinsically safe current output

- 1 Voltage supply
- 2 Relay output
- 3 Signal output 8/16 mA/HART active
- 4 Signal output 8/16 mA/HART passive
- 5 Interface for sensor-sensor communication (MGC)
- 6 Setting the bus address for sensor-sensor communication (MGC)³⁾

Adjustment and connection compartment - Non-Ex instruments and instruments with non-intrinsically safe current output

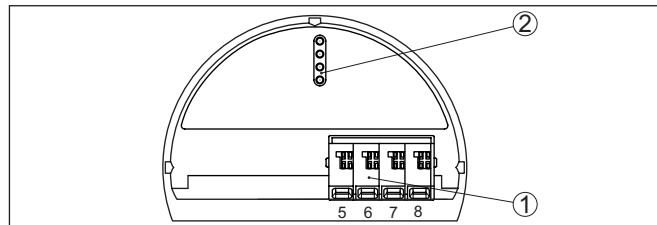

Fig. 14: Adjustment and connection compartment with non-Ex instruments and instruments with non-intrinsically safe current output

- 1 Terminals for the external display and adjustment unit
- 2 Contact pins for the display and adjustment module or interface adapter

Connection to a PLC

If inductive loads or stronger currents are switched through, the gold plating on the relay contact surface will be permanently damaged. The contact is then no longer suitable for switching low-voltage circuits.

Inductive loads also result from the connection to a PLC input or output and/or in combination with long cables. It is imperative that you

³⁾ MGC = Multi Gauge Communication

take measures to extinguish sparks to protect the relay contact (e.g. Z diode) or the transistor or 8/16 mA output.

Instruments with intrinsically safe current output



You can find detailed information on the explosion-protected versions (Ex ia, Ex d) in the Ex-specific safety instructions. These safety instructions are part of the scope of delivery and come with the Ex-approved instruments.

Electronics and connection compartment - Instruments with intrinsically safe current output

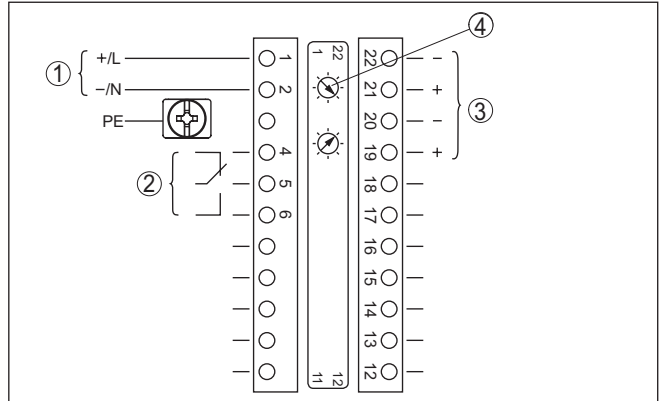

Fig. 15: Electronics and connection compartment (Ex d) with instruments with intrinsically safe current output

- 1 Voltage supply
- 2 Relay output
- 3 Interface for sensor-sensor communication (MGC)
- 4 Setting the bus address for sensor-sensor communication (MGC)⁴⁾

Adjustment and connection compartment - Instruments with intrinsically safe current output

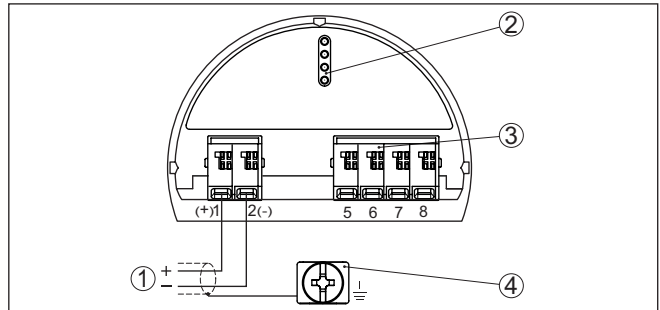

Fig. 16: Adjustment and connection compartment (Ex ia) with instruments with intrinsically safe current output

- 1 Terminals for intrinsically safe signal output 8/16 mA/HART active
- 2 Contact pins for the display and adjustment module or interface adapter
- 3 Terminals for the external display and adjustment unit
- 4 Ground terminal

⁴⁾ MGC = Multi Gauge Communication

Connection to a PLC

If inductive loads or stronger currents are switched through, the gold plating on the relay contact surface will be permanently damaged. The contact is then no longer suitable for switching low-voltage circuits.

Inductive loads also result from the connection to a PLC input or output and/or in combination with long cables. It is imperative that you take measures to extinguish sparks to protect the relay contact (e.g. Z diode) or the transistor or 8/16 mA output.

Electronics and connection compartment - summation**4.4 Connection - Summation**

To measure the level in very high vessels, multiple instruments can be cascaded.

Cascading means that two or several instruments are connected which can together cover a longer measuring range.

The instrument acts as Primary and all other instruments operate as Secondaries.

The pulse rates of all instruments are summed in the Primary instrument and converted into a common signal.

The Primary instrument must have the function "Level". For this purpose, select under the menu item " *Setup - Application*" the function "Level".

Set the address setting (MGC) on the Primary instrument to "99".

For this, the Secondary instruments must be defined as "Summation Secondary". Select under the menu item " *Setup - Application*" the function "Summation Secondary".

The address setting (MGC) on the Secondary instruments can be freely selected. Only the address "99" is reserved for the Primary instrument.

**Note:**

Make sure that all instruments are using the same software version. Software version 2.0 is not downward-compatible.

Connect the instruments according to the following wiring plan:

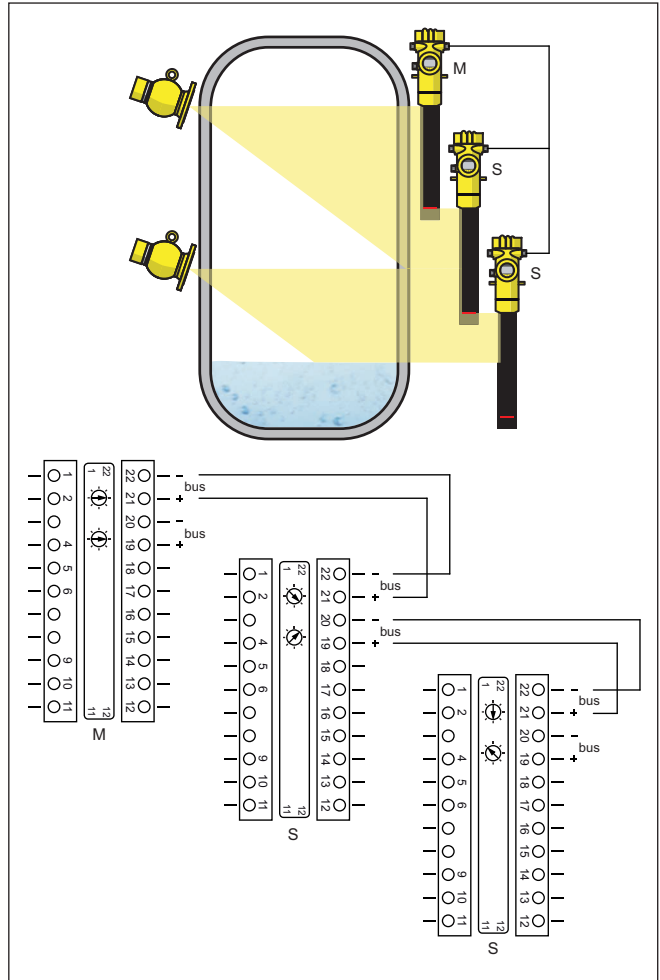

Fig. 17: Electronics and connection compartment with cascading of several instruments.

M Primary instrument

S Secondary instrument



Information:

For example, a radial connection would be also possible as an alternative. Take note of the polarity.

The selection of the two terminal pairs is individual.

5 Functional safety (SIL)

5.1 Objective

Background

In case of dangerous failures, processing facilities and machines can cause risks for persons, environment and property. The risk of such failures must be judged by the plant operator. Dependent thereon are measures for risk reduction through error prevention, error detection and fault control.

Plant safety by risk reduction

The part of plant safety depending on the correct functioning of safety-related components for risk reduction is called functional safety. Components used in such safety-instrumented systems (SIS) must therefore execute their intended function (safety function) with a defined high probability.

Standards and safety levels

The safety requirements for such components are described in the international standards IEC 61508 and 61511, which set the standard for uniform and comparable judgement of instrument and plant (or machine) safety and hence contribute to worldwide legal certainty. We distinguish between four safety levels, from SIL1 for low risk to SIL4 for very high risk (SIL = Safety Integrity Level), depending on the required degree of risk reduction.

5.2 SIL qualification

Properties and requirements

When developing instruments that can be used in safety-instrumented systems, the focus is on avoiding systematic errors as well as determining and controlling random errors.

Here are the most important characteristics and requirements from the perspective of functional safety according to IEC 61508 (Edition 2):

- Internal monitoring of safety-relevant circuit parts
- Extended standardization of the software development
- In case of failure, switching of the safety-relevant outputs to a defined safe state
- Determination of the failure probability of the defined safety function
- Reliable parameterization with non-safe user environment
- Proof test

Safety Manual

The SIL qualification of components is specified in a manual on functional safety (Safety Manual). Here, you can find all safety-relevant characteristics and information the user and the planner need for planning and operating the safety-instrumented system. This document is attached to each instrument with SIL rating and can be also found on our homepage via the search.

5.3 Application area

The instrument can be used for point level detection or level measurement of liquids and bulk solids in safety-instrumented systems (SIS)

according to IEC 61508 and IEC 61511. Take note of the specifications in the Safety Manual.

The following inputs/outputs are permitted:

- Relay output
- 4 ... 20 mA current output

5.4 Safety concept of the parameterization

Tool for operation and parameterization

The following tools are permitted for parameterization of the safety function:

- The integrated display and adjustment unit for on-site adjustment
- The DTM suitable for the device in conjunction with an adjustment software according to the FDT/DTM standard, e. g. PACTware



Note:

For operation of the FIBERTRAC 32 an actual DTM Collection is required. The modification of safety-relevant parameters is only possible with active connection to the instrument (online mode).

Safe parameterization

To avoid possible errors during parameter adjustment in a non-safe user environment, a verification procedure is used that makes it possible to detect parameter adjustment errors reliably. For this, safety-relevant parameters must be verified after they are stored in the device. In normal operating condition, the instrument is also locked against parameter changes through unauthorized access.

Safety-relevant parameters

To prevent unintentional or unauthorized adjustment, the set parameters must be protected from unauthorized access. For this reason the instrument is shipped in locked condition. The PIN in delivery status is "0000".

When shipped with a specific parameter adjustment, the instruments are accompanied by a list with the values deviating from the basic setting.

All safety-relevant parameters must be verified after a change.

The parameter settings of the measurement loop must be documented. You can find a list of all safety-relevant parameters in the delivery status in chapter " *Setup with the display and adjustment module*" under " *Additional adjustments - Reset*". In addition, a list of the safety-relevant parameters can be stored and printed via PACTware/DTM.

Unlock adjustment

For each parameter change, the instrument must be unlocked via a PIN (see chapter " *Parameter adjustment, setup steps - Lock adjustment*"). The device status is indicated in the DTM by the symbol of an unlocked or locked padlock.



In delivery status, the PIN is **0000**.

Unsafe device status



Warning:

If adjustment is enabled, the safety function must be considered as unreliable. This applies until the parameterisation is terminated correctly. If necessary, other measures must be taken to maintain the safety function.

- Change parameters** All parameters changed by the operator are automatically stored temporarily so that they can be verified in the next step.
- Verify parameters/Lock adjustment** After setup, the modified parameters must be verified (confirm the correctness of the parameters). To do this, you first have to enter the device code. Here the adjustment is locked automatically. Then you carry out a comparison of two character strings. You must confirm that the character strings are identical. This is used to check the character presentation.
Then you confirm that the serial number of your instrument has been carried over correctly. This is used to check device communication.
Then, all modified parameters that have to be confirmed are listed. After this process is terminated, the safety function is again ensured.
- Incomplete process**  **Warning:**
If the described process was not carried out completely or correctly (e.g. due to interruption or voltage loss), the instrument remains in an unlocked, and thus unsafe, status.
- Instrument reset**  **Warning:**
In case of a reset to basic settings, all safety-relevant parameters will also be reset to default. Therefore all safety-relevant parameters must be checked or readjusted.

6 Set up with the display and adjustment module

Mount/dismount display and adjustment module

6.1 Insert display and adjustment module

The display and adjustment module can be inserted into the sensor and removed again at any time. It is not necessary to interrupt the voltage supply.

Proceed as follows:

1. Unscrew the small housing cover
2. Place the display and adjustment module in the desired position on the electronics (you can choose any one of four different positions - each displaced by 90°)
3. Press the display and adjustment module onto the electronics and turn it to the right until it snaps in
4. Screw housing lid with inspection window tightly back on

Disassembly is carried out in reverse order.

The display and adjustment module is powered by the sensor, an additional connection is not necessary.

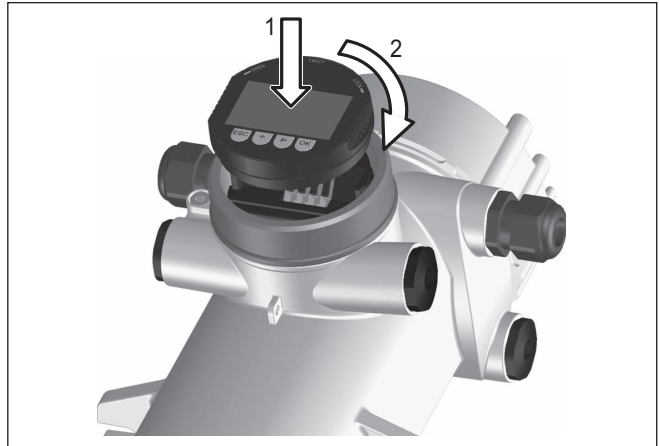

Fig. 18: Insert display and adjustment module



Note:

If you intend to retrofit the instrument with a display and adjustment module for continuous measured value indication, a higher lid with an inspection glass is required.

6.2 Parameter adjustment - Summation Secondary

To measure the level in very high vessels, multiple instruments can be cascaded.

Cascading

Cascading means that two or several instruments are connected which can together cover a longer measuring range.

The instrument acts as Primary and all other instruments operate as Secondaries.

The pulse rates of all instruments are summed in the Primary instrument and converted into a common signal.

First of all, define the function of the Secondary instruments before you define the Primary instrument. The Primary instrument can thus immediately recognize the connected Secondaries.

For this, the Secondary instruments must be defined as "Summation Secondary". Select under the menu item " *Setup - Application*" the function "Summation Secondary".

The address setting (MGC) on the Secondary instruments can be freely selected. Only the address "99" is reserved for the Primary instrument.

The Primary instrument must have the function "Level". For this purpose, select under the menu item " *Setup - Application*" the function "Level".

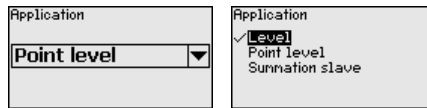

Set the address setting (MGC) on the Primary instrument to "99".

You have to enter the addresses of the Secondary instruments in the list of the Primary instruments. This function is not possible in the supply and adjustment module. To do this you need PACTware with the respective DTM.

6.2.1 Setup

Enter here, the respective application.

This menu item enables adaptation of the sensor to the requested application. You can choose between the following applications: " *Level*", " *Point level*" or " *Summation Secondary*".

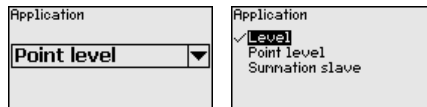

Application

Outputs

In this menu item you can activate the function of the current output.

When the output is activated, the instrument remains in its function as a Secondary, but the 4 ... 20 mA output of the FIBERTRAC 32 can be also used als single instrument.

When the output is active, the instrument has the complete functionality of a level measuring instrument. In this case, continue reading under " *Parameter adjustment/Level measurement*".

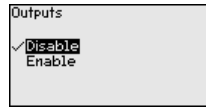
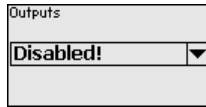

7 Supplement

7.1 Technical data

Note for approved instruments

The technical data in the respective safety instructions which are included in delivery are valid for approved instruments (e.g. with Ex approval). These data can differ from the data listed herein, for example regarding the process conditions or the voltage supply.

All approval documents can be downloaded from our homepage.

Electromechanical data - version IP66/IP67

Options of the cable entry

- Cable entry M20 x 1.5; ½ NPT
- Cable gland M20 x 1.5; ½ NPT (cable diameter see below table)
- Blind plug M20 x 1.5; ½ NPT
- Closing cap ½ NPT

Material cable gland	Material seal insert	Cable diameter				
		4.5 ... 8.5 mm	5 ... 9 mm	6 ... 12 mm	7 ... 12 mm	10 ... 14 mm
PA	NBR	-	●	●	-	●
Brass, nickel-plated	NBR	●	●	●	-	-
Stainless steel	NBR	-	●	●	-	●

Flammability class - Supply lines at least VW-1

Wire cross-section (spring-loaded terminals)

- Massive wire, stranded wire 0.2 ... 2.5 mm² (AWG 24 ... 14)
- Stranded wire with end sleeve 0.2 ... 1.5 mm² (AWG 24 ... 16)

Voltage supply

Operating voltage 24 ... 65 V DC (-15 ... +10 %) or 24 ... 230 V AC (-15 ... +10 %), 50/60 Hz

Reverse voltage protection Available

Max. power consumption 6 VA (AC); 4 W (DC)



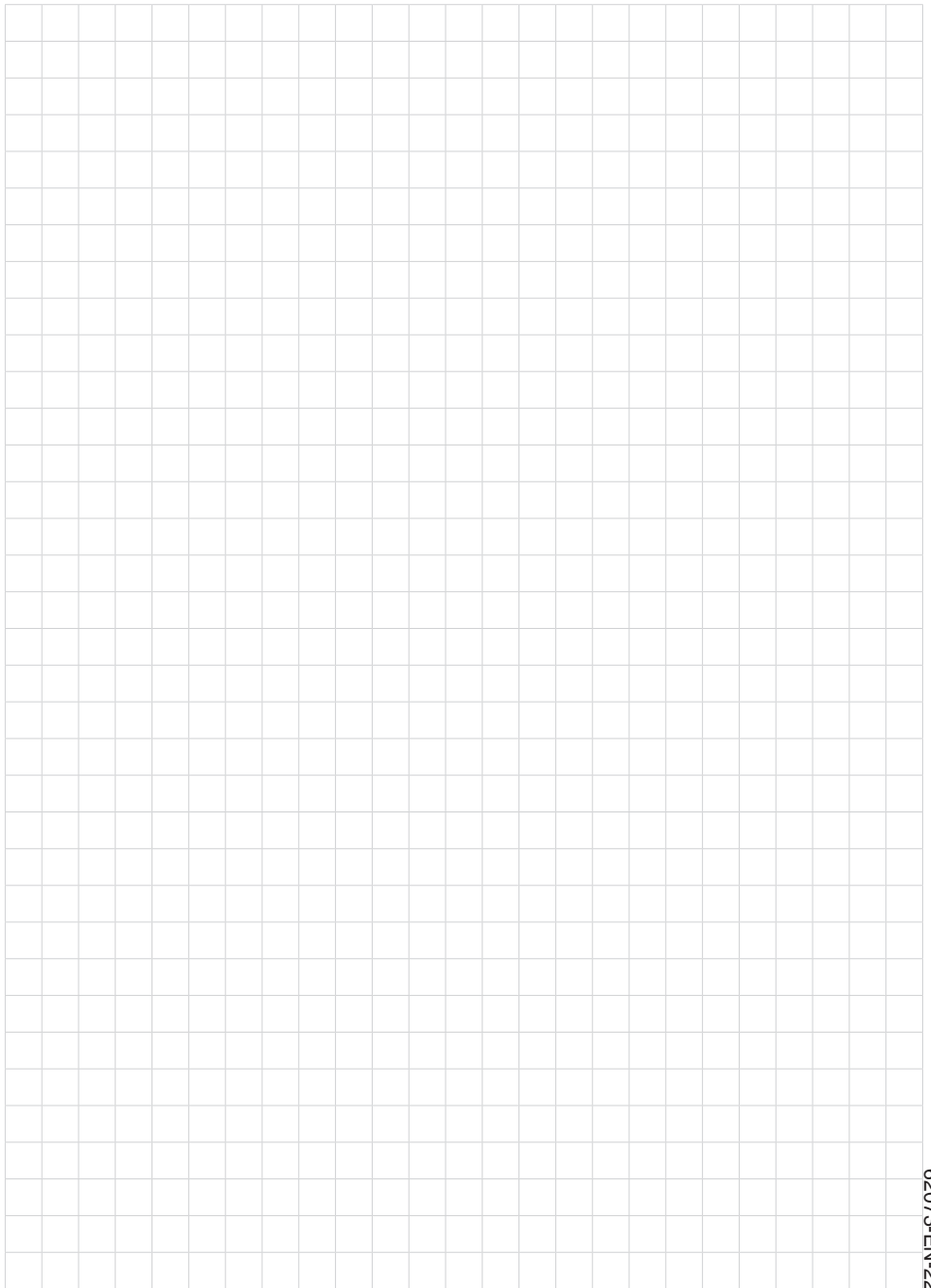



Printing date:

VEGA

All statements concerning scope of delivery, application, practical use and operating conditions of the sensors and processing systems correspond to the information available at the time of printing.

Subject to change without prior notice

© VEGA Grieshaber KG, Schiltach/Germany 2022



62073-EN-221207

VEGA Grieshaber KG
Am Hohenstein 113
77761 Schiltach
Germany

Phone +49 7836 50-0
E-mail: info.de@vega.com
www.vega.com