

# Quick setup guide

Radiometric sensor for continuous level and interface measurement

## FIBERTRAC 31

Foundation Fieldbus



Document ID: 62068



**VEGA**

# Contents

<b>1</b>	<b>For your safety .....</b>	<b>3</b>
1.1	Authorised personnel .....	3
1.2	Appropriate use.....	3
1.3	Warning about incorrect use.....	3
1.4	General safety instructions .....	3
1.5	Conformity.....	4
1.6	NAMUR recommendations .....	4
1.7	Installation and operation in the USA and Canada .....	4
1.8	Environmental instructions .....	4
<b>2</b>	<b>Product description .....</b>	<b>6</b>
2.1	Configuration.....	6
2.2	Principle of operation.....	7
2.3	Corresponding source container .....	7
<b>3</b>	<b>Mounting.....</b>	<b>9</b>
3.1	General instructions .....	9
3.2	Mounting instructions .....	10
<b>4</b>	<b>Connecting to power supply.....</b>	<b>14</b>
4.1	Preparing the connection .....	14
4.2	Connection - Level measurement.....	16
4.3	Connection - Level detection .....	18
4.4	Connection - Summation.....	20
<b>5</b>	<b>Set up with the display and adjustment module .....</b>	<b>22</b>
5.1	Insert display and adjustment module .....	22
5.2	Parameter adjustment - Summation Secondary.....	22
<b>6</b>	<b>Supplement .....</b>	<b>25</b>
6.1	Technical data .....	25



**Information:**

This quick setup guide enables quick setup and commissioning of your instrument.

You can find supplementary information in the corresponding, more detailed Operating Instructions Manual as well as the Safety Manual that comes with instruments with SIL qualification. These manuals are available on our homepage.

**Operating instructions FIBERTRAC 31, Foundation Fieldbus:  
Document-ID 41780**

Editing status of the quick setup guide: 2022-11-22

# 1 For your safety

## 1.1 Authorised personnel

All operations described in this documentation must be carried out only by trained, qualified personnel authorised by the plant operator.

During work on and with the device, the required personal protective equipment must always be worn.

## 1.2 Appropriate use

FIBERTRAC 31 is a sensor for continuous level measurement.

You can find detailed information about the area of application in chapter " *Product description*".

Operational reliability is ensured only if the instrument is properly used according to the specifications in the operating instructions manual as well as possible supplementary instructions.

## 1.3 Warning about incorrect use

Inappropriate or incorrect use of this product can give rise to application-specific hazards, e.g. vessel overflow through incorrect mounting or adjustment. Damage to property and persons or environmental contamination can result. Also, the protective characteristics of the instrument can be impaired.

## 1.4 General safety instructions

This is a state-of-the-art instrument complying with all prevailing regulations and directives. The instrument must only be operated in a technically flawless and reliable condition. The operator is responsible for the trouble-free operation of the instrument. When measuring aggressive or corrosive media that can cause a dangerous situation if the instrument malfunctions, the operator has to implement suitable measures to make sure the instrument is functioning properly.

The safety instructions in this operating instructions manual, the national installation standards as well as the valid safety regulations and accident prevention rules must be observed by the user.

For safety and warranty reasons, any invasive work on the device beyond that described in the operating instructions manual may be carried out only by personnel authorised by the manufacturer. Arbitrary conversions or modifications are explicitly forbidden. For safety reasons, only the accessory specified by the manufacturer must be used.

To avoid any danger, the safety approval markings and safety tips on the device must also be observed.

This measuring system uses gamma rays. Therefore take note of the instructions for radiation protection in chapter " *Product description*". Any work on the source container may only be carried out under the supervision of a qualified radiation protection officer.

## 1.5 Conformity

The device complies with the legal requirements of the applicable country-specific directives or technical regulations. We confirm conformity with the corresponding labelling.

The corresponding conformity declarations can be found on our homepage.

### **Electromagnetic compatibility**

Instruments with plastic housing are designed for use in an industrial environment. Nevertheless, electromagnetic interference from electrical conductors and radiated emissions must be taken into account, as is usual with class A instruments according to EN 61326-1. If the instrument is used in a different environment, the electromagnetic compatibility to other instruments must be ensured by suitable measures.

## 1.6 NAMUR recommendations

NAMUR is the automation technology user association in the process industry in Germany. The published NAMUR recommendations are accepted as the standard in field instrumentation.

The device fulfils the requirements of the following NAMUR recommendations:

- NE 21 – Electromagnetic compatibility of equipment
- NE 43 – Signal level for fault information from measuring transducers
- NE 53 – Compatibility of field devices and display/adjustment components
- NE 107 – Self-monitoring and diagnosis of field devices

For further information see [www.namur.de](http://www.namur.de).

## 1.7 Installation and operation in the USA and Canada

This information is only valid for USA and Canada. Hence the following text is only available in the English language.

Installations in the US shall comply with the relevant requirements of the National Electrical Code (ANSI/NFPA 70).

Installations in Canada shall comply with the relevant requirements of the Canadian Electrical Code.

## 1.8 Environmental instructions

Protection of the environment is one of our most important duties. That is why we have introduced an environment management system with the goal of continuously improving company environmental protection. The environment management system is certified according to DIN EN ISO 14001.

Please help us fulfil this obligation by observing the environmental instructions in this manual:

- Chapter " *Packaging, transport and storage*"

- Chapter "*Disposal*"

## 2 Product description

### 2.1 Configuration

#### Type label

The type label contains the most important data for identification and use of the instrument:

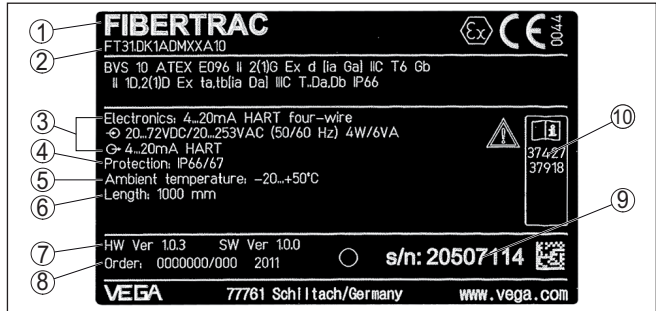

Fig. 1: Layout of the type label (example)

- 1 Instrument type
- 2 Product code
- 3 Electronics
- 4 Protection rating
- 5 Ambient temperature
- 6 Measuring range
- 7 Hardware and software version
- 8 Order number
- 9 Serial number of the instrument
- 10 ID numbers, instrument documentation

#### Stainless steel type label

Adhesive labels can peel off or become illegible under harsh ambient conditions or the influence of aggressive materials.

The optional stainless steel type label is screwed tightly to the housing and the labelling is permanently resistant.

The stainless steel type label cannot be retrofitted.

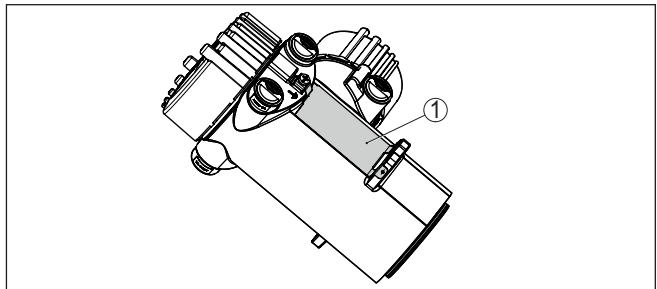

Fig. 2: Position of the stainless steel type label

- 1 Stainless steel type label

#### Serial number - Instrument search

The type label contains the serial number of the instrument. With it you can find the following instrument data on our homepage:

- Product code (HTML)
- Delivery date (HTML)
- Order-specific instrument features (HTML)
- Operating instructions and quick setup guide at the time of shipment (PDF)
- Test certificate (PDF) - optional

Move to "[www.vega.com](http://www.vega.com)" and enter in the search field the serial number of your instrument.

Alternatively, you can access the data via your smartphone:

- Download the VEGA Tools app from the "*Apple App Store*" or the "*Google Play Store*"
- Scan the QR-code on the type label of the device or
- Enter the serial number manually in the app

## 2.2 Principle of operation

### Application area

The instrument is suitable for applications in liquids and bulk solids in vessels under difficult process conditions. There are application possibilities in nearly all areas of industry.

The level is detected contactlessly right through the vessel wall.

Neither a process fitting nor a vessel opening are required. The instrument is thus ideal for retro installation.

### Functional principle

In radiometric measurement, a Caesium-137 or Cobalt-60 isotope emits focussed gamma rays that are attenuated when penetrating the vessel wall and the medium. The PVT detector on the opposite side of the tank receives the radiation, whose strength is dependent on the level. The measuring principle has proven to be very reliable in conjunction with extreme process conditions because it measures contactlessly from outside through the vessel wall. The measuring system ensures maximum safety, reliability and plant availability, independently of the medium and its properties.

## 2.3 Corresponding source container

A radioactive isotope in a suitable source holder is the prerequisite for a radiometric measurement setup.

The handling of radioactive substances is regulated by law. The radiation protection rules of the country in which the system is operated apply first and foremost.

In Germany, for example, the current radiation protection ordinance (StrlSchV) based on the Atomic Energy Law (AtG) applies.

The following points are important for measurement with radiometric methods:

### Handling permit

A handling permit is required for operation of a system using gamma rays. This permit is issued by the respective government office or the responsible authority (in Germany, for example, offices for environmental protection, trade supervisory boards, etc.)

You can find further instructions in the operating instructions manual of the source container.

### General instructions for radiation protection

When handling radioactive sources, unnecessary radiation exposure must be avoided. An unavoidable radiation exposure must be kept as low as possible. Take note of the following three important measures:

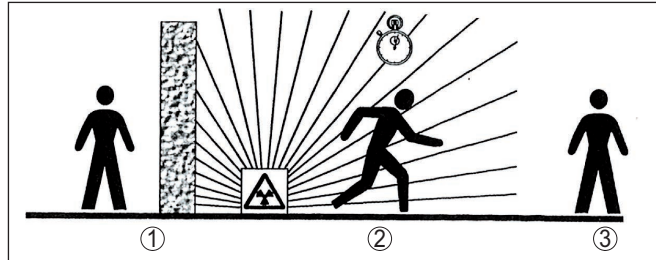

Fig. 3: Measures for protection against radioactive radiation

- 1 Shielding
- 2 Time
- 3 Distance

**Shielding:** Provide good shielding between the source and yourself as well as all other persons. Special source containers (e.g. VEGASOURCE) as well as all materials with high density (e.g. lead, iron, concrete, etc.) provide effective shielding.

**Time:** Stay as short a time as possible in radiation exposed areas.

**Distance:** Your distance to the source should be as large as possible. The local dose rate of the radiation decreases in proportion to the square of the distance to the radiation source.

### Radiation safety officer

The plant operator must appoint a radiation safety officer with the necessary expert knowledge. He is responsible for ensuring that the radiation protection ordinance is complied with and for implementing all radiation protection measures.

### Control area

Control areas are areas in which the local dose rate exceeds a certain value. Only persons who undergo official dose monitoring are allowed into these control areas. You can find the respectively valid limit values for control areas in the guideline of the respective authority (in Germany, for example, the radiation protection ordinance).

We are at your disposal for further information concerning radiation protection and regulations in other countries.



## 3 Mounting

### 3.1 General instructions

#### Switch off source

The source container is part of the measuring system. In case the source container is already equipped with an active isotope, the source container must be locked before mounting.



#### Danger:

Before mounting; make sure that the source is securely closed. Use a padlock to secure the source container in the closed condition and prevent it from being inadvertently opened.

#### Protection against moisture

Protect your instrument against moisture ingress through the following measures:

- Use a suitable connection cable (see chapter " *Connecting to power supply* ")
- Tighten the cable gland or plug connector
- Lead the connection cable downward in front of the cable entry or plug connector

This applies mainly to outdoor installations, in areas where high humidity is expected (e.g. through cleaning processes) and on cooled or heated vessels.



#### Note:

Make sure that during installation or maintenance no moisture or dirt can get inside the instrument.

To maintain the housing protection, make sure that the housing lid is closed during operation and locked, if necessary.

#### Process conditions



#### Note:

For safety reasons, the instrument must only be operated within the permissible process conditions. You can find detailed information on the process conditions in chapter " *Technical data* " of the operating instructions or on the type label.

Hence make sure before mounting that all parts of the instrument exposed to the process are suitable for the existing process conditions.

These are mainly:

- Active measuring component
- Process fitting
- Process seal

Process conditions in particular are:

- Process pressure
- Process temperature
- Chemical properties of the medium
- Abrasion and mechanical influences

**Cable glands****Metric threads**

In the case of instrument housings with metric thread, the cable glands are screwed in at the factory. They are sealed with plastic plugs as transport protection.

You have to remove these plugs before electrical connection.

**NPT thread**

In the case of instrument housings with self-sealing NPT threads, it is not possible to have the cable entries screwed in at the factory. The free openings for the cable glands are therefore covered with red dust protection caps as transport protection.

Prior to setup you have to replace these protective caps with approved cable glands or close the openings with suitable blind plugs.

The suitable cable glands and blind plugs come with the instrument.

**3.2 Mounting instructions****Installation position****Note:**

During the planning, our specialists will analyse the conditions of the measurement loop to dimension the isotope accordingly.

You get a "Source Sizing" document specifying the required source activity and containing all relevant mounting information for your measuring point.

You must follow the instructions in this "Source Sizing" document in addition to the following mounting instructions.

The following mounting information is applicable as long as there is nothing else specified in the "Source Sizing" document.

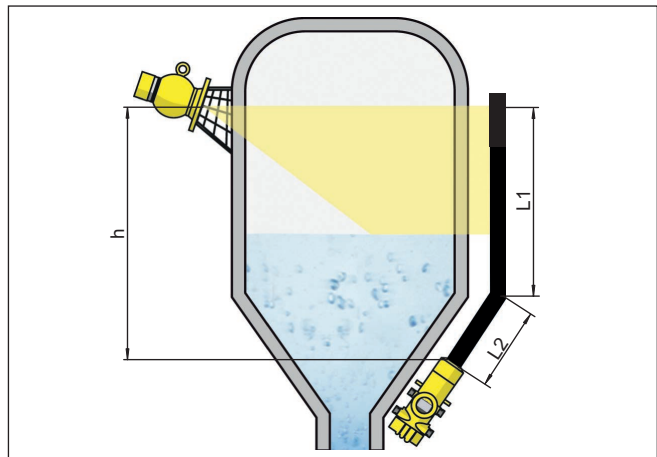

Fig. 4: Level measurement in a storage tank

*h* Measuring range

*L* Measurement length (*L*1, *L*2)

You can find information on protective barriers and the mounting of the corresponding source container in the operating instructions manual of the source container, e.g. VEGASOURCE.

You can mount the FIBERTRAC 31 with the housing head upward or downward. When the housing head is mounted downward, the housing itself is more easily accessible.

Fasten the sensor in such a way that it cannot fall out of the holder. If necessary, provide the sensor with a support from below.

Direct the exit angle of the source container to the FIBERTRAC 31.

Mount the source container as close as possible to the vessel. If there are gaps, secure the area with a safety fence and protective grating so that no one can reach into the dangerous area.

### Mounting clamps

You can mount the sensor on your vessel with the enclosed mounting clamps. A number of mounting clamps come with the FIBERTRAC 31 depending on the length of the sensor.

Use a mounting clamp approx. every 450 mm (17.72 in). During mounting, adjust the distances between the attached mounting clips.

Take note of the minimum bending radius of the sensor, which is 305 mm (12 in).

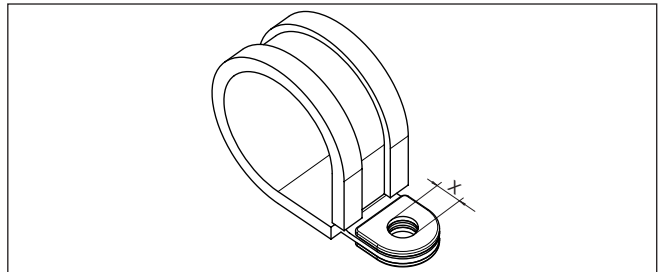

Fig. 5: Mounting clamp

x Hole for screw M8

→ Determine the exact mounting position of one or several mounting clamps and mark the holes.

Align the mounting positions exactly and average the distances between the enclosed mounting clamps.

Drill appropriate holes (max. M12) for fastening the mounting clamps.



**Note:**

The mounting clamps do not come with fastening screws. Use fastening elements that are appropriate for the situation in your plant.

### Summation

To measure the level in very high vessels, multiple instruments can be cascaded.

Cascading means that two or several instruments are connected which can together cover a longer measuring range.

You can find the exact number of Secondaries in the " Safety Manual".

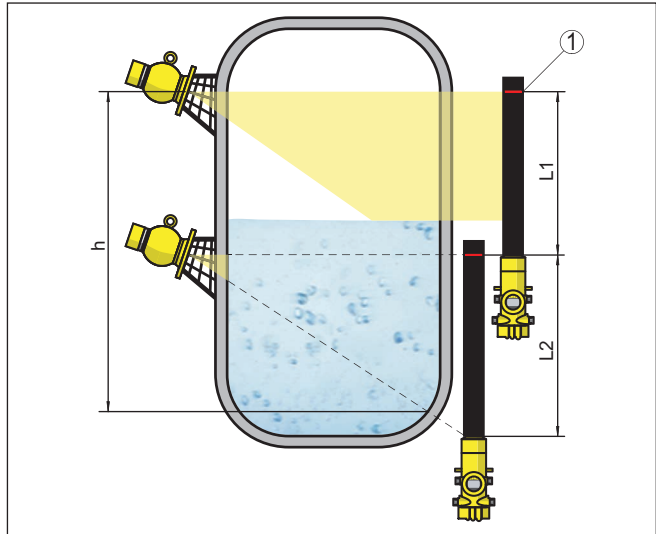

Fig. 6: Installation position - cascading arrangement

*h* Summed measuring range

*L* Measurement length ( $L_1$ ,  $L_2$ )

*1* Red marking line for designating the measuring range

Here, one instrument acts as a Primary and all other instruments operate as Summation Secondary. The pulse rates of all instruments are summed in the Primary instrument and converted into a common signal.

If several sensors are cascaded, the measuring ranges of the individual detectors must directly join each other. The detectors must also slightly overlap.

Make sure that the red marking lines directly join the measuring range of the next FIBERTRAC 31.

Mount the FIBERTRAC 31 in such a way that the detector hose is directly in the radiated area of the source container. Mount the FIBERTRAC 31 preferably side by side and make sure that no detector hose is hidden by another sensor.

### Vessel with heat insulation

On vessels with temperature insulation, the sensor and the source container should be preferably mounted outside of the tank insulation.

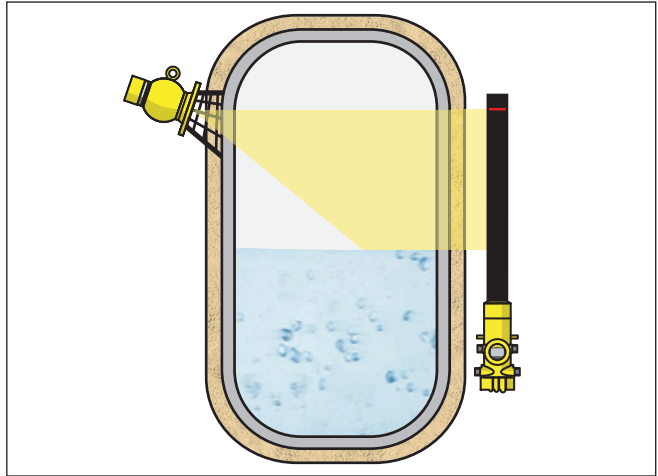

Fig. 7: Level measurement on a heated vessel with heat insulation

If this is not possible, make sure that there is a sufficiently large cut-out in the tank insulation for mounting the sensor and the source container. Make sure that the max. ambient temperature of the sensor is not exceeded.

### Protection against heat

If the max. ambient temperature is exceeded, you must take suitable measures to protect the instrument against overheating.

You can protect the instrument by providing a suitable insulation against the heat or mounting the instrument further away from the heat source.

Make sure these measures are taken into account already in the planning stage. If you want to carry out such measures later on, contact our specialists to ensure that the accuracy of the application is not impaired.

If these measures are not sufficient to maintain the max. ambient temperature, you could consider using the water or air cooling system we offer for FIBERTRAC 31.

The cooling system must also be included in the calculations for the measuring point. Contact our specialists regarding the dimensioning of the cooling.

## 4 Connecting to power supply

### 4.1 Preparing the connection

#### Safety instructions

Always keep in mind the following safety instructions:

- The electrical connection must only be carried out by trained, qualified personnel authorised by the plant operator.
- If overvoltage surges are expected, overvoltage arresters should be installed.



#### Warning:

Only connect or disconnect in de-energized state.



#### Note:

Install a disconnecting device for the instrument which is easy to access. The disconnecting device must be marked for the instrument (IEC/EN 61010).

#### Connection technology

The voltage supply and signal output are connected via the spring-loaded terminals in the housing.

Connection to the display and adjustment module or to the interface adapter is carried out via contact pins in the housing.

#### Connection procedure

Proceed as follows:

The procedure applies to instruments without explosion protection.

1. Unscrew the big housing cover
2. Loosen compression nut of the cable gland and remove blind plug
3. Remove approx. 10 cm (4 in) of the cable mantle, strip approx. 1 cm (0.4 in) of insulation from the ends of the individual wires
4. Insert the cable into the sensor through the cable entry

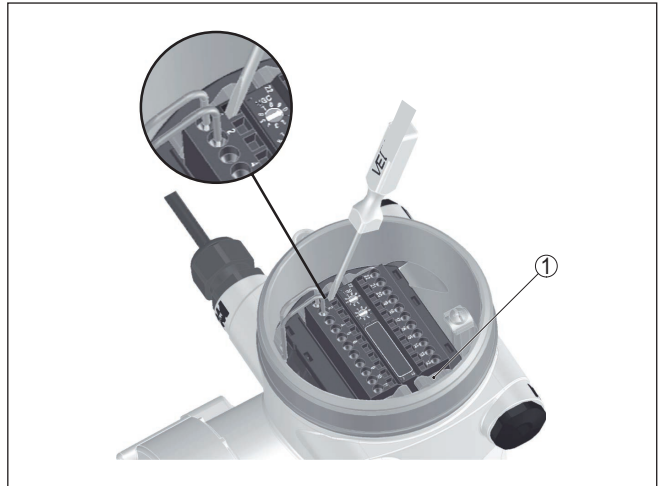

Fig. 8: Connection steps 4 and 5

1 Locking of the terminal blocks

5. Insert a small slotted screwdriver firmly into the rectangular lock openings of the respective connection terminal
6. Insert the wire ends into the round openings of the terminals according to the wiring plan

**i** **Information:**

Solid cores as well as flexible cores with cable end sleeves are inserted directly into the terminal openings. In case of flexible cores without end sleeves, press the rectangular lock opening with a small screwdriver; the terminal opening is freed. When the screwdriver is released, the terminal opening closes again.

7. Check the hold of the wires in the terminals by lightly pulling on them  
To loosen a line, insert a small slotted screwdriver firmly into the rectangular lock opening according to the illustration
8. Connect the shielding to the internal ground terminal, connect the external ground terminal to potential equalisation
9. Tighten the compression nut of the cable entry gland. The seal ring must completely encircle the cable
10. Screw the housing lid back on

The electrical connection is finished.

**i** **Information:**

The terminal blocks are pluggable and can be detached from the electronics. To do this, loosen the two lateral locking levers of the terminal block with a small screwdriver. When loosening the locking, the terminal block is automatically squeezed out. It must snap in place when re-inserted.

## 4.2 Connection - Level measurement

### Non-Ex instruments and instruments with non-intrinsically safe signal output

Electronics and connection compartment - Non-Ex instruments and instruments with non-intrinsically safe signal output

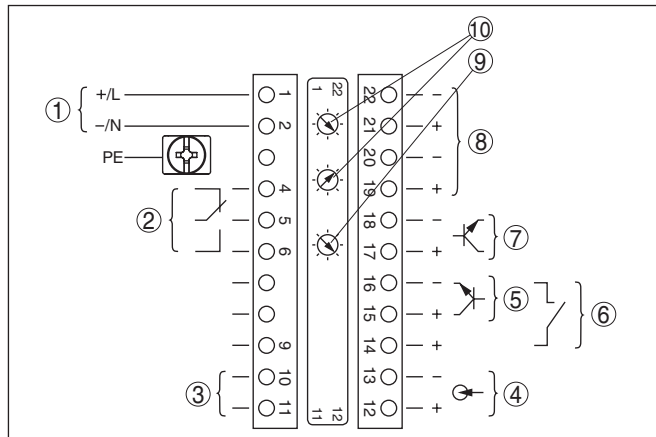

Fig. 9: Electronics and connection compartment with non-Ex instruments and instruments with non-intrinsically safe signal output

- 1 Voltage supply
- 2 Relay output
- 3 Signal output FF bus
- 4 Signal input 4 ... 20 mA (active sensor)
- 5 Switching input for NPN transistor
- 6 Switching input floating
- 7 Transistor output
- 8 Interface for sensor-sensor communication (MGC)
- 9 Simulation switch (1 = simulation on)
- 10 Setting the bus address for sensor-sensor communication (MGC)<sup>1)</sup>

Adjustment and connection compartment - Non-Ex instruments and instruments with non-intrinsically safe signal output

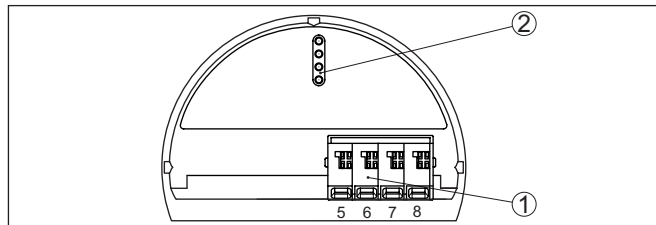

Fig. 10: Adjustment and connection compartment with non-Ex instruments and instruments with non-intrinsically safe signal output

- 1 Terminals for the external display and adjustment unit
- 2 Contact pins for the display and adjustment module or interface adapter

### Instruments with intrinsically safe signal output



You can find detailed information on the explosion-protected versions (Ex ia, Ex d) in the Ex-specific safety instructions. These safety

<sup>1)</sup> MGC = Multi Gauge Communication



instructions are part of the scope of delivery and come with the Ex-approved instruments.

**Electronics and connection compartment - Instruments with intrinsically safe signal output**

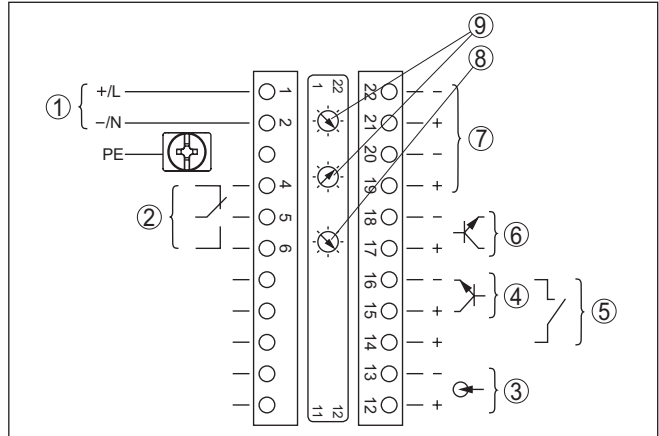

Fig. 11: Electronics and connection compartment (Ex d) with instruments with intrinsically safe signal output

- 1 Voltage supply
- 2 Relay output
- 3 Signal input 4 ... 20 mA (active sensor)
- 4 Switching input for NPN transistor
- 5 Switching input floating
- 6 Transistor output
- 7 Interface for sensor-sensor communication (MGC)
- 8 Simulation switch (1 = simulation on)
- 9 Setting the bus address for sensor-sensor communication (MGC)<sup>2)</sup>

**Adjustment and connection compartment - Instruments with intrinsically safe signal output**

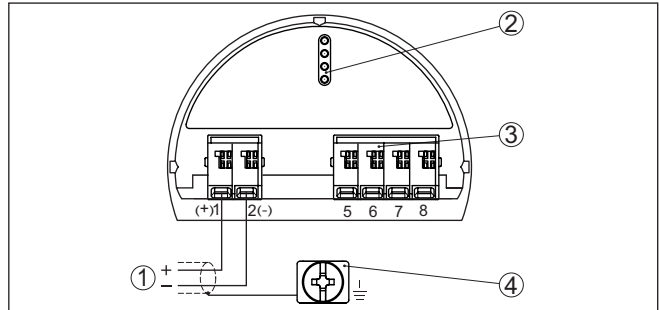

Fig. 12: Adjustment and connection compartment (Ex ia) with instruments with intrinsically safe signal output

- 1 Terminals for intrinsically safe signal output FF bus
- 2 Contact pins for the display and adjustment module or interface adapter
- 3 Terminals for the external display and adjustment unit
- 4 Ground terminal

<sup>2)</sup> MGC = Multi Gauge Communication

### 4.3 Connection - Level detection

#### Non-Ex instruments and instruments with non-intrinsically safe signal output

Electronics and connection compartment - Non-Ex instruments and instruments with non-intrinsically safe signal output

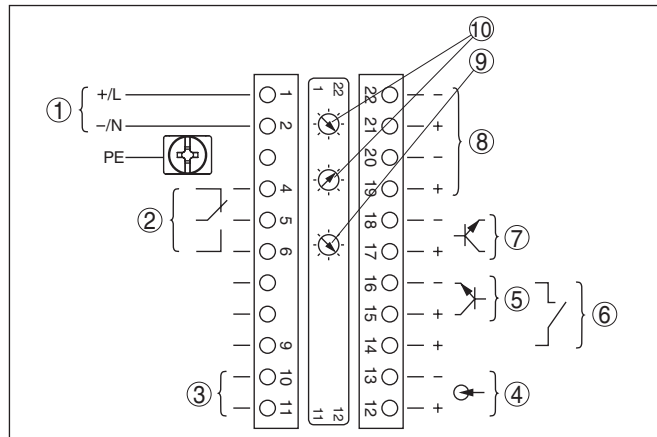

Fig. 13: Electronics and connection compartment with non-Ex instruments and instruments with non-intrinsically safe signal output

- 1 Voltage supply
- 2 Relay output
- 3 Signal output FF bus
- 4 Signal input 4 ... 20 mA (active sensor)
- 5 Switching input for NPN transistor
- 6 Switching input floating
- 7 Transistor output
- 8 Interface for sensor-sensor communication (MGC)
- 9 Simulation switch (1 = simulation on)
- 10 Setting the bus address for sensor-sensor communication (MGC)<sup>3)</sup>

Adjustment and connection compartment - Non-Ex instruments and instruments with non-intrinsically safe signal output

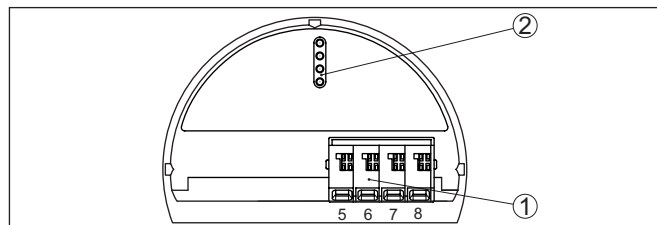

Fig. 14: Adjustment and connection compartment with non-Ex instruments and instruments with non-intrinsically safe signal output

- 1 Terminals for the external display and adjustment unit
- 2 Contact pins for the display and adjustment module or interface adapter

#### Connection to a PLC

If inductive loads or stronger currents are switched through, the gold plating on the relay contact surface will be permanently damaged.

<sup>3)</sup> MGC = Multi Gauge Communication

The contact is then no longer suitable for switching low-voltage circuits.

Inductive loads also result from the connection to a PLC input or output and/or in combination with long cables. It is imperative that you take measures to extinguish sparks to protect the relay contact (e.g. Z diode) or the transistor or 8/16 mA output.

**Instruments with intrinsically safe signal output**



You can find detailed information on the explosion-protected versions (Ex ia, Ex d) in the Ex-specific safety instructions. These safety instructions are part of the scope of delivery and come with the Ex-approved instruments.

**Electronics and connection compartment - Instruments with intrinsically safe signal output**

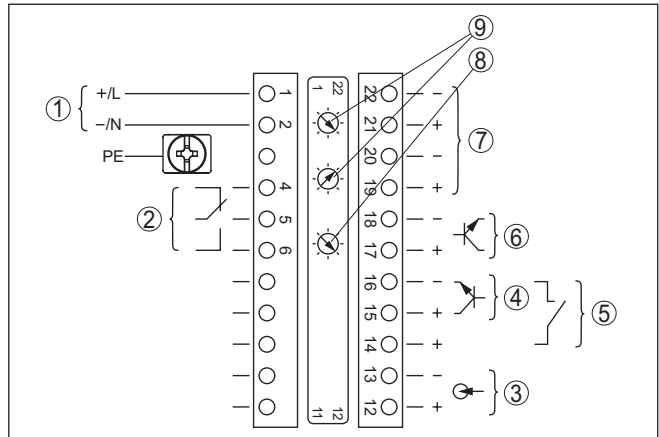

Fig. 15: Electronics and connection compartment (Ex d) with instruments with intrinsically safe signal output

- 1 Voltage supply
- 2 Relay output
- 3 Signal input 4 ... 20 mA (active sensor)
- 4 Switching input for NPN transistor
- 5 Switching input floating
- 6 Transistor output
- 7 Interface for sensor-sensor communication (MGC)
- 8 Simulation switch (1 = simulation on)
- 9 Setting the bus address for sensor-sensor communication (MGC)<sup>4)</sup>

<sup>4)</sup> MGC = Multi Gauge Communication

### Adjustment and connection compartment - Instruments with intrinsically safe signal output

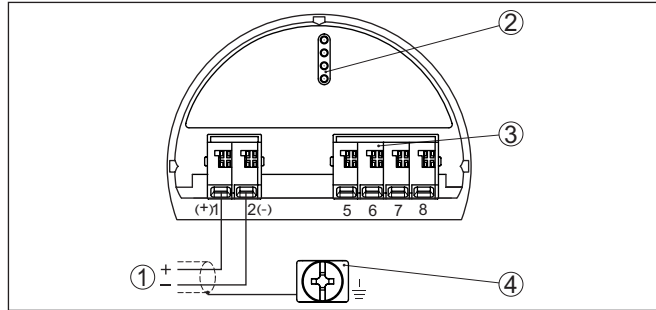

Fig. 16: Adjustment and connection compartment (Ex ia) with instruments with intrinsically safe signal output

- 1 Terminals for intrinsically safe signal output FF bus
- 2 Contact pins for the display and adjustment module or interface adapter
- 3 Terminals for the external display and adjustment unit
- 4 Ground terminal

### Connection to a PLC

If inductive loads or stronger currents are switched through, the gold plating on the relay contact surface will be permanently damaged. The contact is then no longer suitable for switching low-voltage circuits.

Inductive loads also result from the connection to a PLC input or output and/or in combination with long cables. It is imperative that you take measures to extinguish sparks to protect the relay contact (e.g. Z diode) or the transistor or 8/16 mA output.

## 4.4 Connection - Summation

### Electronics and connection compartment - summation

To measure the level in very high vessels, multiple instruments can be cascaded.

Cascading means that two or several instruments are connected which can together cover a longer measuring range.

The instrument acts as Primary and all other instruments operate as Secondaries.

The pulse rates of all instruments are summed in the Primary instrument and converted into a common signal.

The Primary instrument must have the function "Level". For this purpose, select under the menu item "Setup - Application" the function "Level".

Set the address setting (MGC) on the Primary instrument to "99".

For this, the Secondary instruments must be defined as "Summation Secondary". Select under the menu item "Setup - Application" the function "Summation Secondary".

The address setting (MGC) on the Secondary instruments can be freely selected. Only the address "99" is reserved for the Primary instrument.



**Note:**

Make sure that all instruments are using the same software version. Software version 2.0 is not downward-compatible.

Connect the instruments according to the following wiring plan:

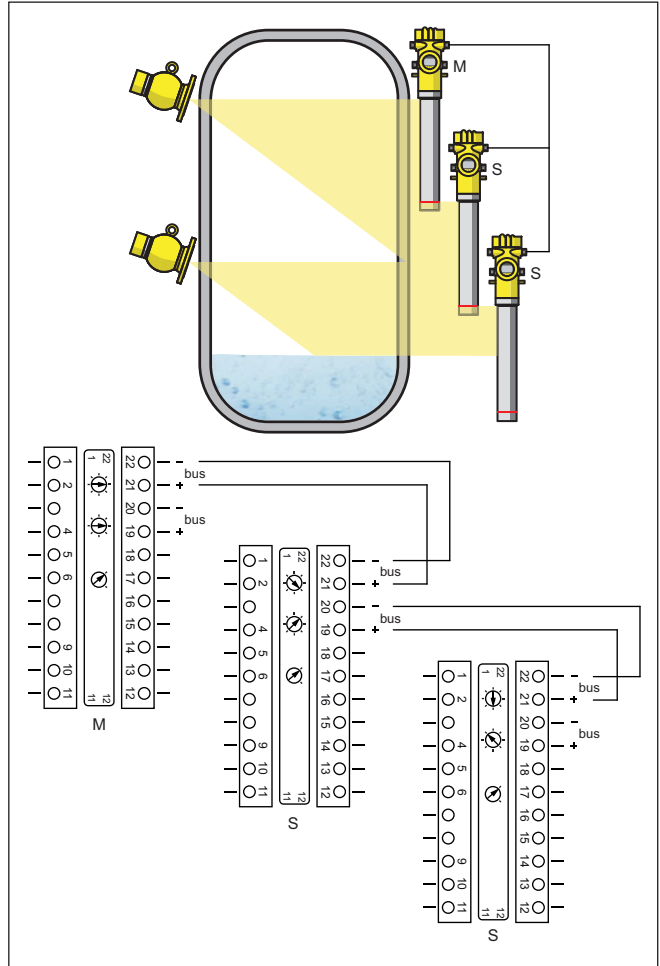

Fig. 17: Electronics and connection compartment with cascading of several instruments.

M Primary instrument

S Secondary instrument



**Information:**

For example, a radial connection would be also possible as an alternative. Take note of the polarity.

The selection of the two terminal pairs is individual.

## 5 Set up with the display and adjustment module

### Mount/dismount display and adjustment module

### 5.1 Insert display and adjustment module

The display and adjustment module can be inserted into the sensor and removed again at any time. It is not necessary to interrupt the voltage supply.

Proceed as follows:

1. Unscrew the small housing cover
2. Place the display and adjustment module in the desired position on the electronics (you can choose any one of four different positions - each displaced by 90°)
3. Press the display and adjustment module onto the electronics and turn it to the right until it snaps in
4. Screw housing lid with inspection window tightly back on

Disassembly is carried out in reverse order.

The display and adjustment module is powered by the sensor, an additional connection is not necessary.

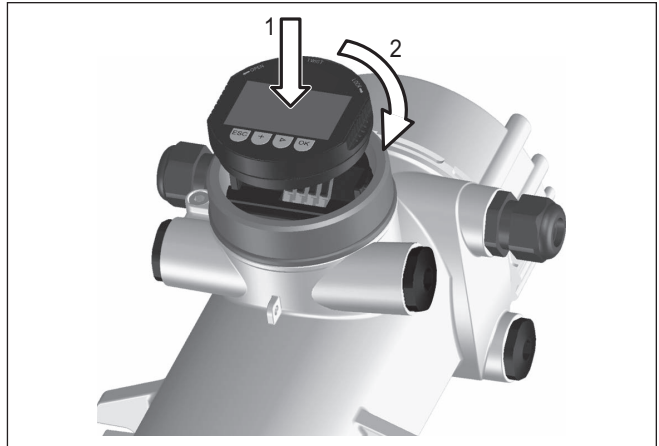

Fig. 18: Insert display and adjustment module



#### Note:

If you intend to retrofit the instrument with a display and adjustment module for continuous measured value indication, a higher lid with an inspection glass is required.

### 5.2 Parameter adjustment - Summation Secondary

To measure the level in very high vessels, multiple instruments can be cascaded.

### Cascading

Cascading means that two or several instruments are connected which can together cover a longer measuring range.

The instrument acts as Primary and all other instruments operate as Secondaries.

The pulse rates of all instruments are summed in the Primary instrument and converted into a common signal.

First of all, define the function of the Secondary instruments before you define the Primary instrument. The Primary instrument can thus immediately recognize the connected Secondaries.

For this, the Secondary instruments must be defined as "Summation Secondary". Select under the menu item " *Setup - Application*" the function "Summation Secondary".

The address setting (MGC) on the Secondary instruments can be freely selected. Only the address "99" is reserved for the Primary instrument.

The Primary instrument must have the function "Level". For this purpose, select under the menu item " *Setup - Application*" the function "Level".

Set the address setting (MGC) on the Primary instrument to "99".

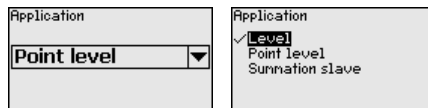

You have to enter the addresses of the Secondary instruments in the list of the Primary instruments. This function is not possible in the supply and adjustment module. To do this you need PACTware with the respective DTM.

### 5.2.1 Setup

Enter here, the respective application.

This menu item enables adaptation of the sensor to the requested application. You can choose between the following applications: " *Level*", " *Point level*" or " *Summation Secondary*".

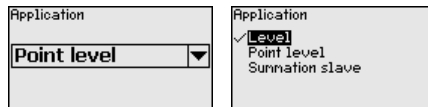

## Application

## Outputs

In this menu item you can activate the function of the current output.

When the output is activated, the instrument remains in its function as a Secondary, but the 4 ... 20 mA output of the FIBERTRAC 31 can be also used als single instrument.

When the output is active, the instrument has the complete functionality of a level measuring instrument. In this case, continue reading under " *Parameter adjustment/Level measurement*".

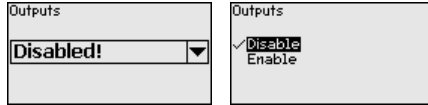



## 6 Supplement

### 6.1 Technical data

#### Note for approved instruments

The technical data in the respective safety instructions which are included in delivery are valid for approved instruments (e.g. with Ex approval). These data can differ from the data listed herein, for example regarding the process conditions or the voltage supply.

All approval documents can be downloaded from our homepage.

#### Electromechanical data - version IP66/IP67

Options of the cable entry

- Cable entry M20 x 1.5; ½ NPT
- Cable gland M20 x 1.5; ½ NPT (cable diameter see below table)
- Blind plug M20 x 1.5; ½ NPT
- Closing cap ½ NPT

Material cable gland	Material seal insert	Cable diameter				
		4.5 ... 8.5 mm	5 ... 9 mm	6 ... 12 mm	7 ... 12 mm	10 ... 14 mm
PA	NBR	-	●	●	-	●
Brass, nickel-plated	NBR	●	●	●	-	-
Stainless steel	NBR	-	●	●	-	●

Flammability class - Supply lines at least VW-1

Wire cross-section (spring-loaded terminals)

- Massive wire, stranded wire 0.2 ... 2.5 mm<sup>2</sup> (AWG 24 ... 14)
- Stranded wire with end sleeve 0.2 ... 1.5 mm<sup>2</sup> (AWG 24 ... 16)

#### Voltage supply

Operating voltage

- Sensor power supply 24 ... 65 V DC (-15 ... +10 %) or 24 ... 230 V AC (-15 ... +10 %), 50/60 Hz
- FF bus 9 ... 32 V DC





Printing date:

**VEGA**

All statements concerning scope of delivery, application, practical use and operating conditions of the sensors and processing systems correspond to the information available at the time of printing.

Subject to change without prior notice

© VEGA Grieshaber KG, Schiltach/Germany 2022



62068-EN-221207

VEGA Grieshaber KG  
Am Hohenstein 113  
77761 Schiltach  
Germany

Phone +49 7836 50-0  
E-mail: [info.de@vega.com](mailto:info.de@vega.com)  
[www.vega.com](http://www.vega.com)