

# Quick setup guide

Radiometric sensor for level detection

## POINTRAC 31

Four-wire 8/16 mA/HART



Document ID: 62079



**VEGA**

# Contents

<b>1</b>	<b>For your safety .....</b>	<b>3</b>
1.1	Authorised personnel .....	3
1.2	Appropriate use.....	3
1.3	Warning about incorrect use.....	3
1.4	General safety instructions .....	3
1.5	Conformity.....	4
1.6	NAMUR recommendations .....	4
1.7	Installation and operation in the USA and Canada .....	4
1.8	Environmental instructions .....	4
<b>2</b>	<b>Product description .....</b>	<b>6</b>
2.1	Configuration.....	6
2.2	Principle of operation.....	7
2.3	Corresponding source container .....	7
<b>3</b>	<b>Mounting.....</b>	<b>9</b>
3.1	General instructions .....	9
3.2	Mounting instructions .....	10
<b>4</b>	<b>Connecting to power supply.....</b>	<b>16</b>
4.1	Preparing the connection .....	16
4.2	Connection.....	18
<b>5</b>	<b>Set up with the display and adjustment module .....</b>	<b>21</b>
5.1	Insert display and adjustment module .....	21
5.2	Parameter adjustment .....	21
<b>6</b>	<b>Supplement .....</b>	<b>24</b>
6.1	Technical data .....	24



**Information:**

This quick setup guide enables quick setup and commissioning of your instrument.

You can find supplementary information in the corresponding, more detailed Operating Instructions Manual as well as the Safety Manual that comes with instruments with SIL qualification. These manuals are available on our homepage.

**Operating instructions POINTRAC 31 - Four-wire 4 ... 20 mA/  
HART: Document-ID 39411**

Editing status of the quick setup guide: 2022-11-22

# 1 For your safety

## 1.1 Authorised personnel

All operations described in this documentation must be carried out only by trained, qualified personnel authorised by the plant operator.

During work on and with the device, the required personal protective equipment must always be worn.

## 1.2 Appropriate use

The POINTRAC 31 is a sensor for point level detection.

You can find detailed information about the area of application in chapter " *Product description*".

Operational reliability is ensured only if the instrument is properly used according to the specifications in the operating instructions manual as well as possible supplementary instructions.

## 1.3 Warning about incorrect use

Inappropriate or incorrect use of this product can give rise to application-specific hazards, e.g. vessel overfill through incorrect mounting or adjustment. Damage to property and persons or environmental contamination can result. Also, the protective characteristics of the instrument can be impaired.

## 1.4 General safety instructions

This is a state-of-the-art instrument complying with all prevailing regulations and directives. The instrument must only be operated in a technically flawless and reliable condition. The operator is responsible for the trouble-free operation of the instrument. When measuring aggressive or corrosive media that can cause a dangerous situation if the instrument malfunctions, the operator has to implement suitable measures to make sure the instrument is functioning properly.

The safety instructions in this operating instructions manual, the national installation standards as well as the valid safety regulations and accident prevention rules must be observed by the user.

For safety and warranty reasons, any invasive work on the device beyond that described in the operating instructions manual may be carried out only by personnel authorised by the manufacturer. Arbitrary conversions or modifications are explicitly forbidden. For safety reasons, only the accessory specified by the manufacturer must be used.

To avoid any danger, the safety approval markings and safety tips on the device must also be observed.

This measuring system uses gamma rays. Therefore take note of the instructions for radiation protection in chapter " *Product description*". Any work on the source container may only be carried out under the supervision of a qualified radiation protection officer.

## 1.5 Conformity

The device complies with the legal requirements of the applicable country-specific directives or technical regulations. We confirm conformity with the corresponding labelling.

The corresponding conformity declarations can be found on our homepage.

### Electromagnetic compatibility

Instruments in four-wire or Ex d ia version are designed for use in an industrial environment. Nevertheless, electromagnetic interference from electrical conductors and radiated emissions must be taken into account, as is usual with class A instruments according to EN 61326-1. If the instrument is used in a different environment, the electromagnetic compatibility to other instruments must be ensured by suitable measures.

## 1.6 NAMUR recommendations

NAMUR is the automation technology user association in the process industry in Germany. The published NAMUR recommendations are accepted as the standard in field instrumentation.

The device fulfils the requirements of the following NAMUR recommendations:

- NE 21 – Electromagnetic compatibility of equipment
- NE 43 – Signal level for fault information from measuring transducers
- NE 53 – Compatibility of field devices and display/adjustment components
- NE 107 – Self-monitoring and diagnosis of field devices

For further information see [www.namur.de](http://www.namur.de).

## 1.7 Installation and operation in the USA and Canada

This information is only valid for USA and Canada. Hence the following text is only available in the English language.

Installations in the US shall comply with the relevant requirements of the National Electrical Code (ANSI/NFPA 70).

Installations in Canada shall comply with the relevant requirements of the Canadian Electrical Code.

## 1.8 Environmental instructions

Protection of the environment is one of our most important duties. That is why we have introduced an environment management system with the goal of continuously improving company environmental protection. The environment management system is certified according to DIN EN ISO 14001.

Please help us fulfil this obligation by observing the environmental instructions in this manual:

- Chapter " *Packaging, transport and storage* "

- Chapter " *Disposal* "

## 2 Product description

### 2.1 Configuration

#### Type label

The type label contains the most important data for identification and use of the instrument:

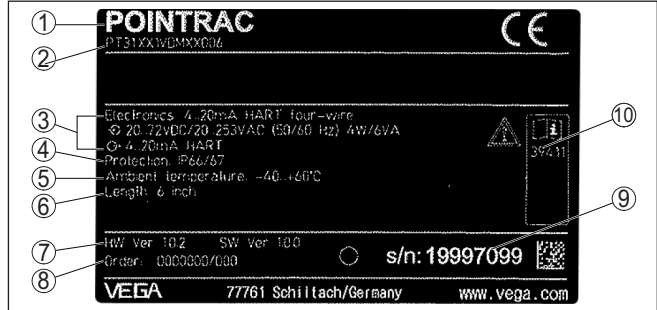

Fig. 1: Layout of the type label (example)

- 1 Instrument type
- 2 Product code
- 3 Electronics
- 4 Protection rating
- 5 Process and ambient temperature, process pressure
- 6 Instrument length
- 7 Hardware and software version
- 8 Order number
- 9 Serial number of the instrument
- 10 ID numbers, instrument documentation

#### Stainless steel type label

Adhesive labels can peel off or become illegible under harsh ambient conditions or the influence of aggressive materials.

The optional stainless steel type label is screwed tightly to the housing and the labelling is permanently resistant.

The stainless steel type label cannot be retrofitted.

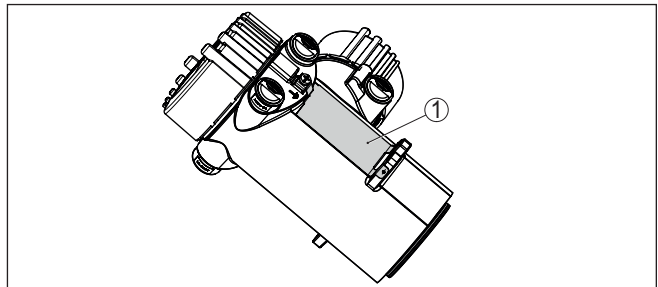

Fig. 2: Position of the stainless steel type label

- 1 Stainless steel type label

#### Serial number - Instrument search

The type label contains the serial number of the instrument. With it you can find the following instrument data on our homepage:

- Product code (HTML)
- Delivery date (HTML)
- Order-specific instrument features (HTML)
- Operating instructions and quick setup guide at the time of shipment (PDF)
- Test certificate (PDF) - optional

Move to "[www.vega.com](http://www.vega.com)" and enter in the search field the serial number of your instrument.

Alternatively, you can access the data via your smartphone:

- Download the VEGA Tools app from the "*Apple App Store*" or the "*Google Play Store*"
- Scan the QR-code on the type label of the device or
- Enter the serial number manually in the app

## 2.2 Principle of operation

### Application area

The instrument is suitable for applications in liquids and bulk solids in vessels under difficult process conditions. There are application possibilities in nearly all areas of industry.

The limit level is detected contactlessly through the vessel wall. Neither a process fitting nor a vessel opening is required. The instrument is thus ideal for retrofitting.

### Functional principle

In radiometric measurement, a Caesium-137 or Cobalt-60 isotope emits focussed gamma rays that are attenuated when penetrating the vessel wall and the medium. The PVT detector on the opposite side of the tank receives the radiation. When the intensity of the radiation drops below a defined value, e.g. due to damping, then the POINTRAC 31 switches. The measuring principle has proven itself well under extreme conditions because it measures contactlessly from outside through the vessel wall. The measuring system ensures maximum safety, reliability and plant availability independent of the medium and its properties.

## 2.3 Corresponding source container

A radioactive isotope in a suitable source holder is the prerequisite for a radiometric measurement setup.

The handling of radioactive substances is regulated by law. The radiation protection rules of the country in which the system is operated apply first and foremost.

In Germany, for example, the current radiation protection ordinance (StrlSchV) based on the Atomic Energy Law (AtG) applies.

The following points are important for measurement with radiometric methods:

### Handling permit

A handling permit is required for operation of a system using gamma rays. This permit is issued by the respective government office or the responsible authority (in Germany, for example, offices for environmental protection, trade supervisory boards, etc.)

You can find further instructions in the operating instructions manual of the source container.

### General instructions for radiation protection

When handling radioactive sources, unnecessary radiation exposure must be avoided. An unavoidable radiation exposure must be kept as low as possible. Take note of the following three important measures:

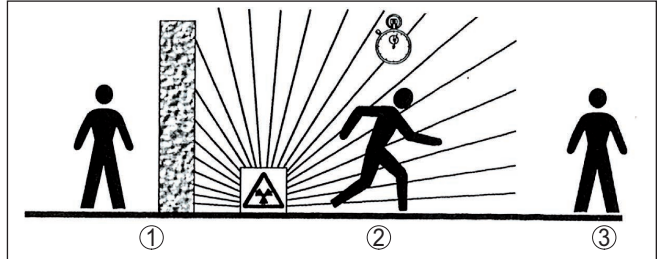

Fig. 3: Measures for protection against radioactive radiation

- 1 Shielding
- 2 Time
- 3 Distance

**Shielding:** Provide good shielding between the source and yourself as well as all other persons. Special source containers (e.g. VEGASOURCE) as well as all materials with high density (e.g. lead, iron, concrete, etc.) provide effective shielding.

**Time:** Stay as short a time as possible in radiation exposed areas.

**Distance:** Your distance to the source should be as large as possible. The local dose rate of the radiation decreases in proportion to the square of the distance to the radiation source.

### Radiation safety officer

The plant operator must appoint a radiation safety officer with the necessary expert knowledge. He is responsible for ensuring that the radiation protection ordinance is complied with and for implementing all radiation protection measures.

### Control area

Control areas are areas in which the local dose rate exceeds a certain value. Only persons who undergo official dose monitoring are allowed into these control areas. You can find the respectively valid limit values for control areas in the guideline of the respective authority (in Germany, for example, the radiation protection ordinance).

We are at your disposal for further information concerning radiation protection and regulations in other countries.



## 3 Mounting

### 3.1 General instructions

#### Switch off source

The source container is part of the measuring system. In case the source container is already equipped with an active isotope, the source container must be locked before mounting.

**Danger:**

Before mounting; make sure that the source is securely closed. Use a padlock to secure the source container in the closed condition and prevent it from being inadvertently opened.

#### Protection against moisture

Protect your instrument against moisture ingress through the following measures:

- Use a suitable connection cable (see chapter " *Connecting to power supply* ")
- Tighten the cable gland or plug connector
- Lead the connection cable downward in front of the cable entry or plug connector

This applies mainly to outdoor installations, in areas where high humidity is expected (e.g. through cleaning processes) and on cooled or heated vessels.

**Note:**

Make sure that during installation or maintenance no moisture or dirt can get inside the instrument.

To maintain the housing protection, make sure that the housing lid is closed during operation and locked, if necessary.

#### Process conditions

**Note:**

For safety reasons, the instrument must only be operated within the permissible process conditions. You can find detailed information on the process conditions in chapter " *Technical data* " of the operating instructions or on the type label.

Hence make sure before mounting that all parts of the instrument exposed to the process are suitable for the existing process conditions.

These are mainly:

- Active measuring component
- Process fitting
- Process seal

Process conditions in particular are:

- Process pressure
- Process temperature
- Chemical properties of the medium
- Abrasion and mechanical influences

**Cable glands****Metric threads**

In the case of instrument housings with metric thread, the cable glands are screwed in at the factory. They are sealed with plastic plugs as transport protection.

You have to remove these plugs before electrical connection.

**NPT thread**

In the case of instrument housings with self-sealing NPT threads, it is not possible to have the cable entries screwed in at the factory. The free openings for the cable glands are therefore covered with red dust protection caps as transport protection.

Prior to setup you have to replace these protective caps with approved cable glands or close the openings with suitable blind plugs.

The suitable cable glands and blind plugs come with the instrument.

**3.2 Mounting instructions****Installation position****Note:**

During the planning, our specialists will analyse the conditions of the measurement loop to dimension the isotope accordingly.

You get a "Source Sizing" document specifying the required source activity and containing all relevant mounting information for your measuring point.

You must follow the instructions in this "Source Sizing" document in addition to the following mounting instructions.

The following mounting information is applicable as long as there is nothing else specified in the "Source Sizing" document.

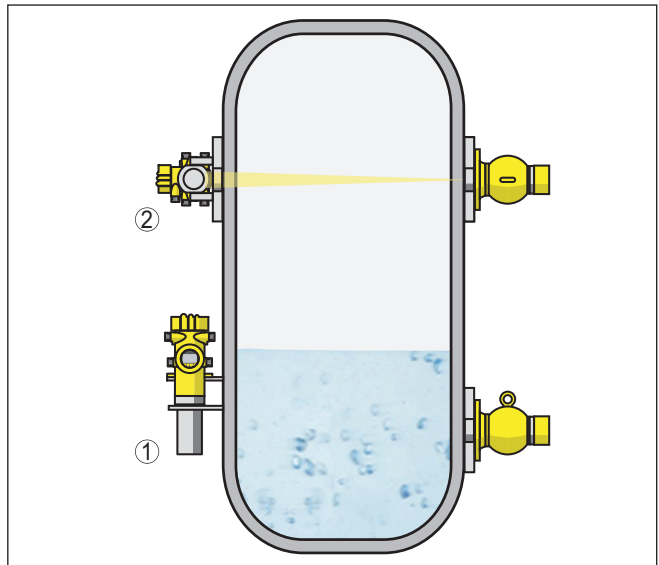

Fig. 4: Mounting position - level detection - version with detector tube

- 1 Vertical mounting
- 2 Mounting horizontally, at right angles to container

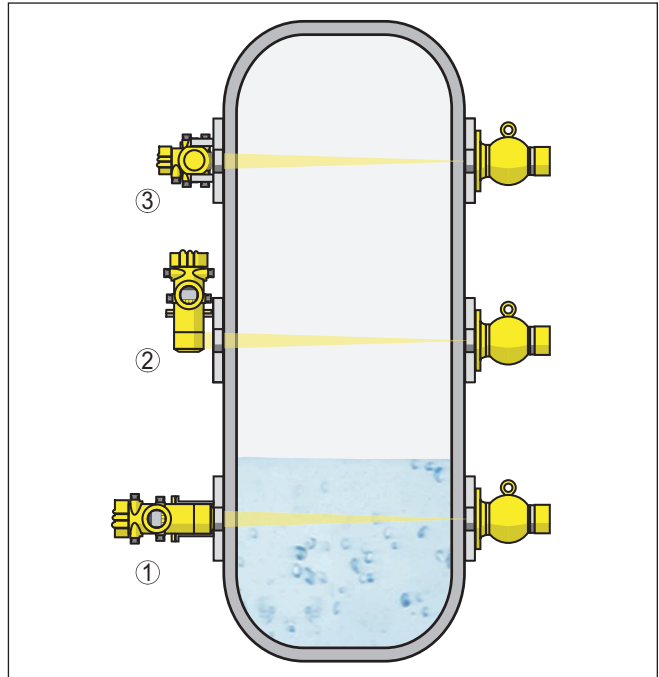

Fig. 5: Mounting position - level detection - version without detector tube

- 1 Horizontal mounting
- 2 Vertical mounting
- 3 Mounting horizontally, at right angles to container

You can find information on protective barriers and the mounting of the corresponding source container in the operating instructions manual of the source container, e.g. VEGASOURCE.

For level detection, the device is generally mounted horizontally at the height of the requested limit level. Make sure that there are no struts or reinforcements at this position in the vessel.

Direct the exit beam of the source container exactly towards the measuring range of POINTRAC 31.

Fasten the devices in such a way that it cannot fall out of the holder. If necessary, provide the device with a support from below.

Mount the source container as close as possible to the vessel. If there are gaps, secure the area with a safety fence and protective grating so that no one can reach into the dangerous area.

### Mounting clamp

You can mount the device (version with detector tube) with the attached mounting clamp to your vessel.

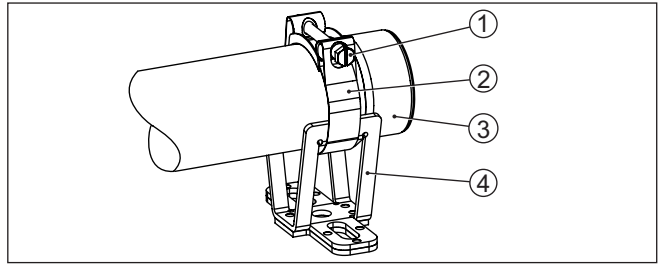

Fig. 6: Mounting clamp

- 1 Screw M8 x 80
- 2 Hinge bolt clamp
- 3 Detector tube
- 4 Console

1. Determine the exact mounting position of the mounting clamp and mark the holes.  
Drill appropriate holes (max. M12) for fastening the mounting clamps.
2. For mounting, insert the detector tube (3) into the V-shape holding fixture of the console (4).  
Draw the hinge bolt clamp (2) according to the illustration through the console (4).  
Screw the hinge bolt clamp (2) together and tighten the screw (1) with a max. torque of 20 Nm (14.75 lbf/ft).



**Note:**

The mounting clamps do not come with fastening screws. Use fastening elements that are appropriate for the situation in your plant.

**Sensor orientation**

**Level detection - max. detection**

The POINTRAC 31 is suitable for level detection in liquids or bulk solids. It is mounted at the height of the requested switching point.

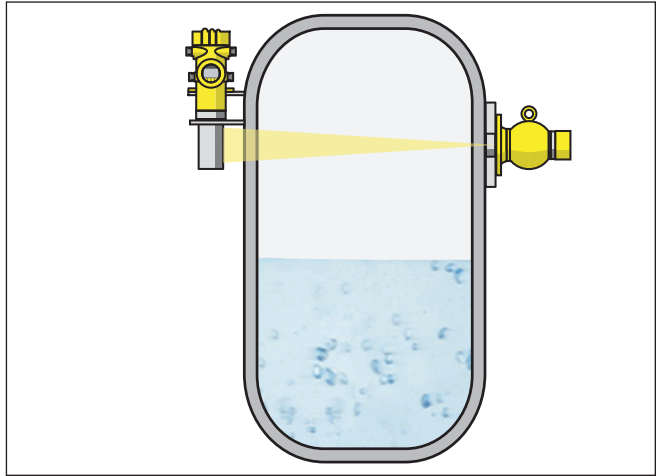

Fig. 7: POINTRAC 31 as max. level detection (uncovered)

**Level detection - min. detection**

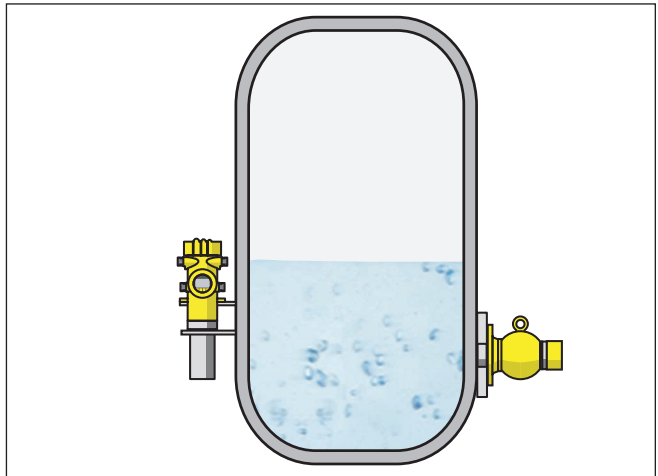

Fig. 8: POINTRAC 31 as min. level detection (covered)

### Bulk solids with low density

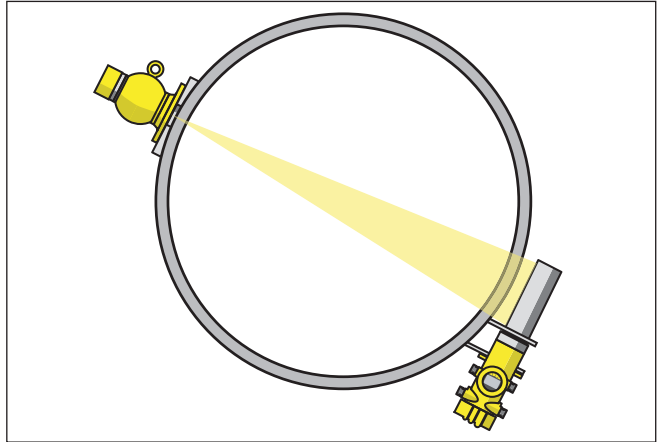

Fig. 9: POINTRAC 31 as level detection (top view)

POINTRAC 31 lends itself well for level detection of bulk solids with low density. Mount the instrument horizontally at the height of the requested switching point.

Mount the source container VEGASOURCE displaced by 90° in order to get the widest possible radiation angle.

When the sensor is covered by the medium, the radiation damping is considerably stronger - hence, the switching point is all the more reliable.

### Protection against heat

If the max. ambient temperature is exceeded, you must take suitable measures to protect the instrument against overheating.

You can protect the instrument by providing a suitable insulation against the heat or mounting the instrument further away from the heat source.

Make sure these measures are taken into account already in the planning stage. If you want to carry out such measures later on, contact our specialists to ensure that the accuracy of the application is not impaired.

If these measures are not sufficient to maintain the max. ambient temperature, you could consider using the water or air cooling system we offer for POINTRAC 31.

The cooling system must also be included in the calculations for the measuring point. Contact our specialists regarding the dimensioning of the cooling.

## 4 Connecting to power supply

### 4.1 Preparing the connection

#### Safety instructions

Always keep in mind the following safety instructions:

- The electrical connection must only be carried out by trained, qualified personnel authorised by the plant operator.
- If overvoltage surges are expected, overvoltage arresters should be installed.



#### Warning:

Only connect or disconnect in de-energized state.



#### Note:

Install a disconnecting device for the instrument which is easy to access. The disconnecting device must be marked for the instrument (IEC/EN 61010).

#### Connection technology

The voltage supply and signal output are connected via the spring-loaded terminals in the housing.

Connection to the display and adjustment module or to the interface adapter is carried out via contact pins in the housing.

#### Connection procedure

Proceed as follows:

The procedure applies to instruments without explosion protection.

1. Unscrew the big housing cover
2. Loosen compression nut of the cable gland and remove blind plug
3. Remove approx. 10 cm (4 in) of the cable mantle, strip approx. 1 cm (0.4 in) of insulation from the ends of the individual wires
4. Insert the cable into the sensor through the cable entry



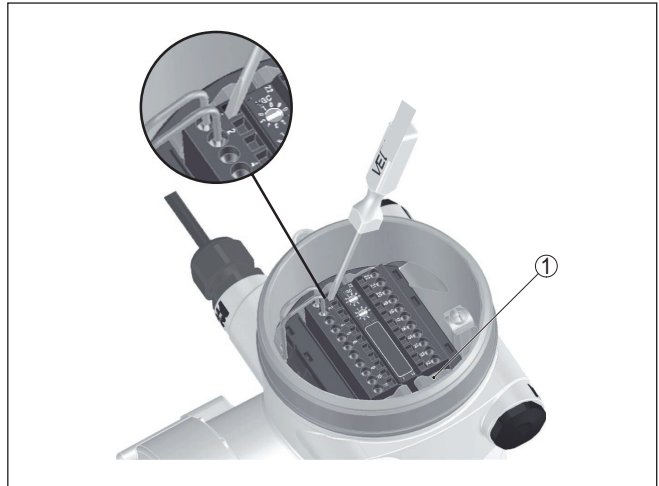

Fig. 10: Connection steps 4 and 5

1 Locking of the terminal blocks

5. Insert a small slotted screwdriver firmly into the rectangular lock openings of the respective connection terminal
6. Insert the wire ends into the round openings of the terminals according to the wiring plan

**i** **Information:**

Solid cores as well as flexible cores with cable end sleeves are inserted directly into the terminal openings. In case of flexible cores without end sleeves, press the rectangular lock opening with a small screwdriver; the terminal opening is freed. When the screwdriver is released, the terminal opening closes again.

7. Check the hold of the wires in the terminals by lightly pulling on them  
To loosen a line, insert a small slotted screwdriver firmly into the rectangular lock opening according to the illustration
8. Connect the shielding to the internal ground terminal, connect the external ground terminal to potential equalisation
9. Tighten the compression nut of the cable entry gland. The seal ring must completely encircle the cable
10. Screw the housing lid back on

The electrical connection is finished.

**i** **Information:**

The terminal blocks are pluggable and can be detached from the electronics. To do this, loosen the two lateral locking levers of the terminal block with a small screwdriver. When loosening the locking, the terminal block is automatically squeezed out. It must snap in place when re-inserted.

## 4.2 Connection

### Non-Ex instruments and instruments with non-intrinsically safe current output

#### Electronics and connection compartment - Non-Ex instruments and instruments with non-intrinsically safe current output

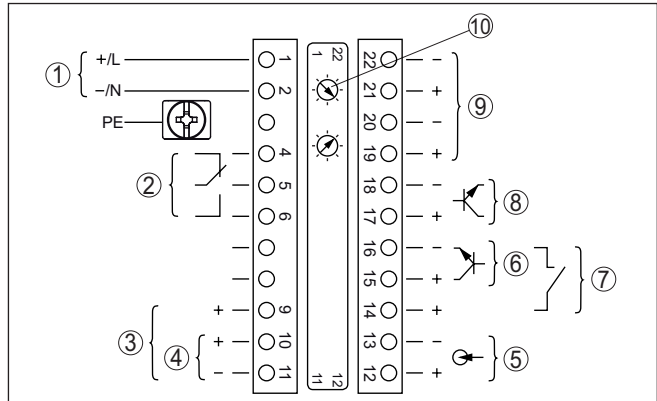

Fig. 11: Electronics and connection compartment with non-Ex instruments and instruments with non-intrinsically safe current output

- 1 Voltage supply
- 2 Relay output
- 3 Signal output 8/16 mA/HART active
- 4 Signal output 8/16 mA/HART Multidrop passive
- 5 Signal input 4 ... 20 mA
- 6 Switching input for NPN transistor
- 7 Switching input floating
- 8 Transistor output
- 9 Interface for sensor-sensor communication (MGC)
- 10 Setting the bus address for sensor-sensor communication (MGC) <sup>1)</sup>

#### Adjustment and connection compartment - Non-Ex instruments and instruments with non-intrinsically safe current output

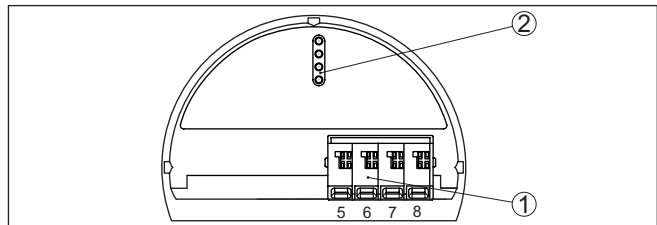

Fig. 12: Adjustment and connection compartment with non-Ex instruments and instruments with non-intrinsically safe current output

- 1 Terminals for the external display and adjustment unit
- 2 Contact pins for the display and adjustment module or interface adapter

#### Connection to a PLC

If inductive loads or stronger currents are switched through, the gold plating on the relay contact surface will be permanently damaged. The contact is then no longer suitable for switching low-voltage circuits.

<sup>1)</sup> MGC = Multi Gauge Communication

Inductive loads also result from the connection to a PLC input or output and/or in combination with long cables. It is imperative that you take measures to extinguish sparks to protect the relay contact (e.g. Z diode) or the transistor or 8/16 mA output.

**Instruments with intrinsically safe current output**



You can find detailed information on the explosion-protected versions (Ex ia, Ex d) in the Ex-specific safety instructions. These safety instructions are part of the scope of delivery and come with the Ex-approved instruments.

**Electronics and connection compartment - Instruments with intrinsically safe current output**

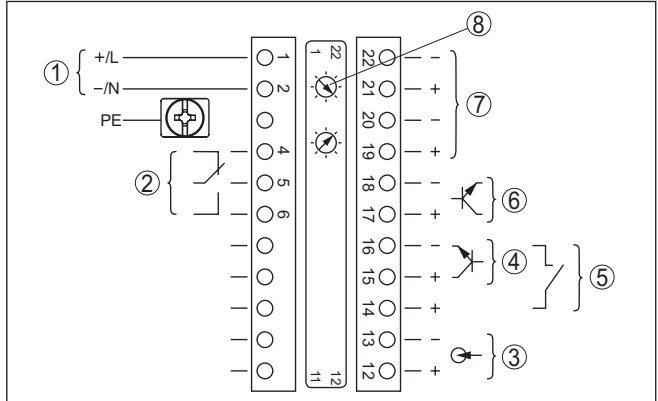

Fig. 13: Electronics and connection compartment (Ex d) with instruments with intrinsically safe current output

- 1 Voltage supply
- 2 Relay output
- 3 Signal input 4 ... 20 mA
- 4 Switching input for NPN transistor
- 5 Switching input floating
- 6 Transistor output
- 7 Interface for sensor-sensor communication (MGC)
- 8 Setting the bus address for sensor-sensor communication (MGC)<sup>2)</sup>

<sup>2)</sup> MGC = Multi Gauge Communication

### Adjustment and connection compartment - Instruments with intrinsically safe current output

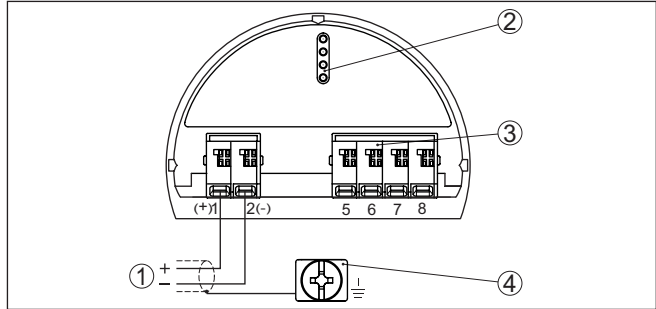

Fig. 14: Adjustment and connection compartment (Ex ia) with instruments with intrinsically safe current output

- 1 Terminals for intrinsically safe signal output 8/16 mA/HART (Multidrop) active
- 2 Contact pins for the display and adjustment module or interface adapter
- 3 Terminals for the external display and adjustment unit
- 4 Ground terminal

### Connection to a PLC

If inductive loads or stronger currents are switched through, the gold plating on the relay contact surface will be permanently damaged. The contact is then no longer suitable for switching low-voltage circuits.

Inductive loads also result from the connection to a PLC input or output and/or in combination with long cables. It is imperative that you take measures to extinguish sparks to protect the relay contact (e.g. Z diode) or the transistor or 8/16 mA output.

## 5 Set up with the display and adjustment module

### Mount/dismount display and adjustment module

### 5.1 Insert display and adjustment module

The display and adjustment module can be inserted into the sensor and removed again at any time. It is not necessary to interrupt the voltage supply.

Proceed as follows:

1. Unscrew the small housing cover
2. Place the display and adjustment module in the desired position on the electronics (you can choose any one of four different positions - each displaced by 90°)
3. Press the display and adjustment module onto the electronics and turn it to the right until it snaps in
4. Screw housing lid with inspection window tightly back on

Disassembly is carried out in reverse order.

The display and adjustment module is powered by the sensor, an additional connection is not necessary.

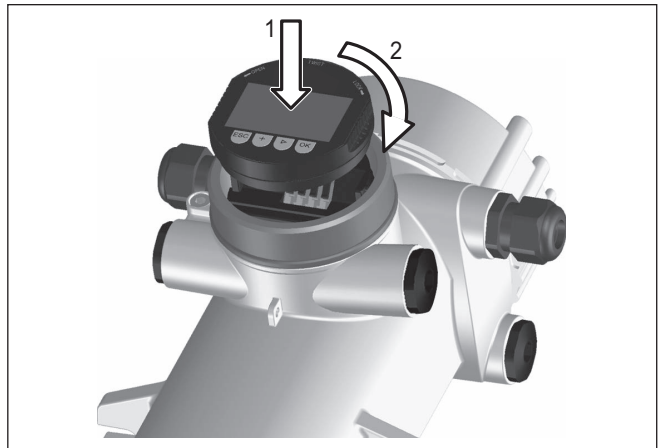

Fig. 15: Insert display and adjustment module



#### Note:

If you intend to retrofit the instrument with a display and adjustment module for continuous measured value indication, a higher lid with an inspection glass is required.

### 5.2 Parameter adjustment

#### 5.2.1 Setup

Enter here, the respective application.

Application

This menu item enables adaptation of the sensor to the requested application. You can choose between the following applications: "Level", "X-ray alarm" or "Real value correction".

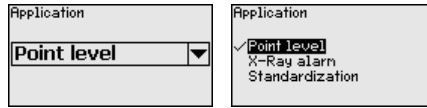

### X-ray alarm

The radiation of external radiation sources can influence the measuring result of continuously measuring, radiometric sensors.

You can also use the POINTRAC 31 as a secondary instrument for detection against X-ray alarm. Hence an alarm can be triggered.

For this function you require PACTware with the respective DTM.

### Real value correction

You can also use the POINTRAC 31 as a Secondary instrument for detection of a defined level. Hence you can automatically correct the measured value of a continuously measuring, radiometric sensor to the real value when this level is reached.

For this function you require PACTware with the respective DTM.

## Adjustment mode

in this menu item you can select if you want to carry out a single or double point adjustment on the sensor.

With the double point adjustment, the Delta I value is selected automatically.

We recommend selecting the double point adjustment. To use this, you must be able to change the level of the vessel so as to carry out the adjustment of the sensor with full status (covered) and with empty status (uncovered).

Hence, you will get a very reliable switching point.

With single point adjustment, you have to define the difference between the min. and max. adjustment points (Delta I) yourself during the following setup.

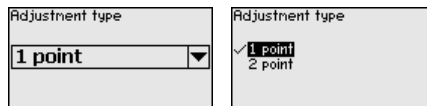

## 5.2.2 Diagnostics

### Device status

In this menu item, you can enquire the status of your sensor. In normal operation, the sensor displays the message "OK". In case of fault, you will find the corresponding fault code here.

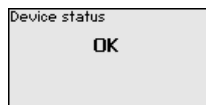



## 6 Supplement

### 6.1 Technical data

#### Note for approved instruments

The technical data in the respective safety instructions which are included in delivery are valid for approved instruments (e.g. with Ex approval). These data can differ from the data listed herein, for example regarding the process conditions or the voltage supply.

All approval documents can be downloaded from our homepage.

#### Electromechanical data - version IP66/IP67

Options of the cable entry

- Cable entry M20 x 1.5; ½ NPT
- Cable gland M20 x 1.5; ½ NPT (cable diameter see below table)
- Blind plug M20 x 1.5; ½ NPT
- Closing cap ½ NPT

Material cable gland	Material seal insert	Cable diameter				
		4.5 ... 8.5 mm	5 ... 9 mm	6 ... 12 mm	7 ... 12 mm	10 ... 14 mm
PA	NBR	-	●	●	-	●
Brass, nickel-plated	NBR	●	●	●	-	-
Stainless steel	NBR	-	●	●	-	●

Flammability class - Supply lines at least VW-1

Wire cross-section (spring-loaded terminals)

- Massive wire, stranded wire 0.2 ... 2.5 mm<sup>2</sup> (AWG 24 ... 14)
- Stranded wire with end sleeve 0.2 ... 1.5 mm<sup>2</sup> (AWG 24 ... 16)

#### Voltage supply

Operating voltage 24 ... 65 V DC (-15 ... +10 %) or 24 ... 230 V AC (-15 ... +10 %), 50/60 Hz

Reverse voltage protection Available

Max. power consumption 6 VA (AC); 4 W (DC)



A large grid of graph paper for taking notes, consisting of 20 columns and 30 rows of small squares.

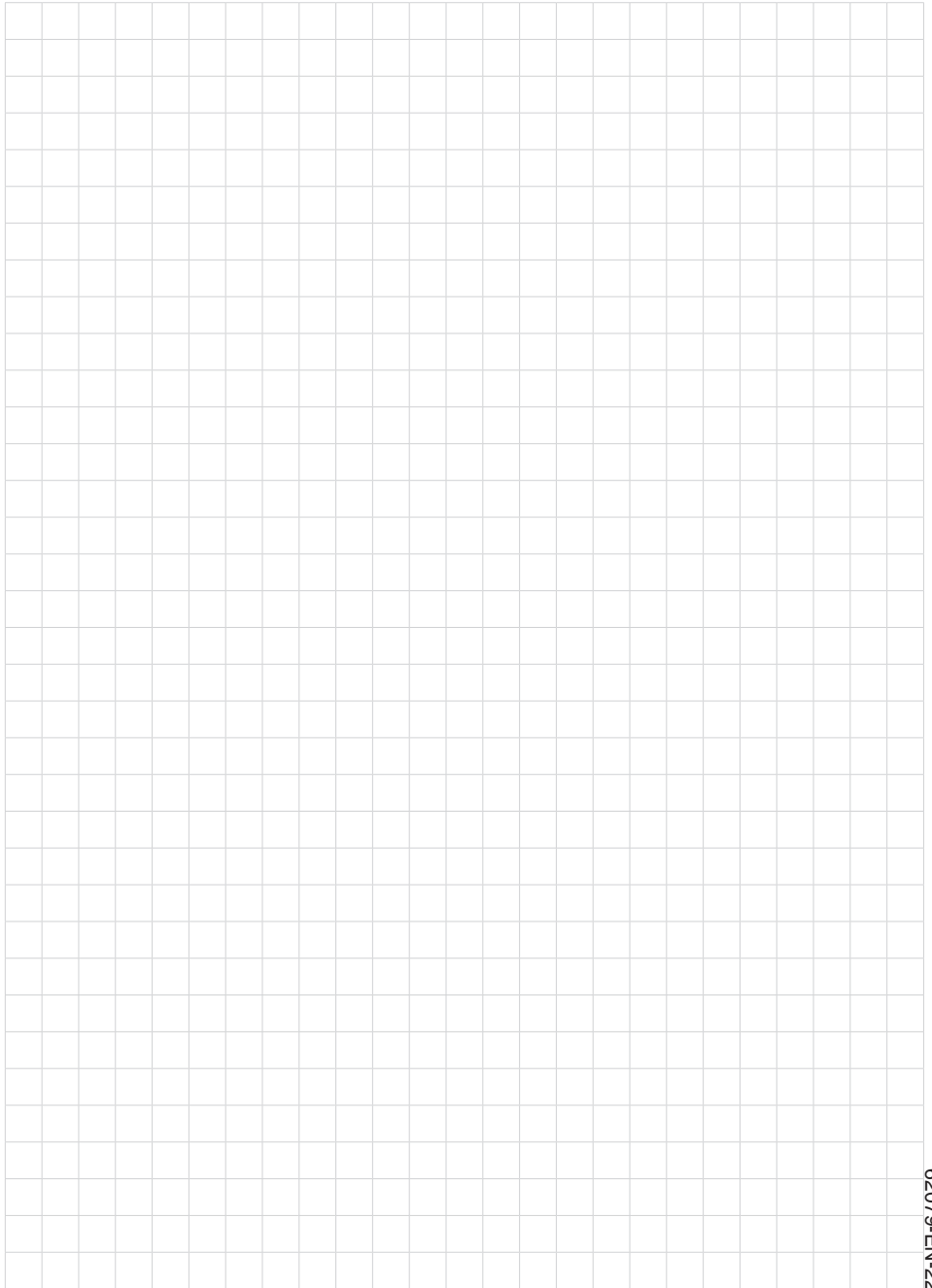



Printing date:

**VEGA**

All statements concerning scope of delivery, application, practical use and operating conditions of the sensors and processing systems correspond to the information available at the time of printing.

Subject to change without prior notice

© VEGA Grieshaber KG, Schiltach/Germany 2022



62079-EN-221207

VEGA Grieshaber KG  
Am Hohenstein 113  
77761 Schiltach  
Germany

Phone +49 7836 50-0  
E-mail: [info.de@vega.com](mailto:info.de@vega.com)  
[www.vega.com](http://www.vega.com)