



# Safety instructions

## VEGAWAVE 61, 62, 63

Intrinsic safety

Two-wire

NAMUR



CE 0044



Document ID: 53829



# VEGA

## Contents

1	Area of applicability.....	4
2	Important specification in the type code.....	4
3	Different ignition protection types .....	6
4	General information.....	6
5	Application area.....	6
6	Specific conditions of use ("X" identification) .....	7
7	Important information for mounting and maintenance.....	8
8	Safe operating mode .....	10
9	Instructions for zone 0, zone 0/1 applications .....	10
10	Potential equalization/Grounding .....	10
11	Electrostatic charging (ESD).....	10
12	Electrical data.....	11
13	Thermal data .....	12

Supplementary documentation:

- Operating instructions VEGAWAVE 61, 62, 63
- EU-type approval certificate PTB 17 ATEX 2014 X (Document ID: 53830)
- EU declaration of conformity (Document ID: 44383)

Editing status: 2021-08-19

DE	Sicherheitshinweise für den Einsatz in explosionsgefährdeten Bereichen
EN	Safety instructions for the use in hazardous areas
FR	Consignes de sécurité pour une application en atmosphères explosibles
IT	Normative di sicurezza per l'impiego in luoghi con pericolo di esplosione
ES	Instrucciones de seguridad para el empleo en áreas con riesgo de explosión
PT	Normas de segurança para utilização em zonas sujeitas a explosão
NL	Veiligheidsaanwijzingen voor gebruik op plaatsen waar ontploffingsgevaar kan heersen
SV	Säkerhetsanvisningar för användning i explosionsfarliga områden
DA	Sikkerhedsforskrifter til anvendelse i explosionsfarlig atmosfære
FI	Turvallisuusohjeet räjähdysvaarallisissa tiloissa käyttöä varten
EL	Υποδείξεις ασφαλείας για τη χρησιμοποίηση σε περιοχές που υπάρχει κίνδυνος έκρηξης

DE	Die vorliegenden Sicherheitshinweise sind im Download unter <a href="http://www.vega.com">www.vega.com</a> standardmäßig in den Sprachen deutsch, englisch, französisch und spanisch verfügbar. Weitere EU-Landessprachen stellt VEGA nach Anforderungen zur Verfügung.
EN	These safety instructions are available as a standard feature in the download area under <a href="http://www.vega.com">www.vega.com</a> in the languages German, English, French and Spanish. Further EU languages will be made available by VEGA upon request.
FR	Les présentes consignes de sécurité sont disponibles au téléchargement sous <a href="http://www.vega.com">www.vega.com</a> en standard en allemand, en anglais, en français et en espagnol. VEGA met à disposition d'autres langues de l'Union Européenne selon les exigences.
ES	Las indicaciones de seguridad presentes están disponibles en la zona de descarga de <a href="http://www.vega.com">www.vega.com</a> de forma estándar en los idiomas inglés, francés y español. VEGA pone a disposición otros idiomas de la UE cuando son requeridos.

## 1 Area of applicability

These safety instructions apply to the level sensors VEGAWAVE 61, 62, 63 of type series:

- WE61(\*).CX/CK\*\*\*Z/N\*\*\*\*
- WE62(\*).CX/CK\*\*\*Z/N\*\*\*\*
- WE63(\*).CX/CK\*\*\*Z/N\*\*\*\*

with the electronics versions

- Z - Two-wire
- N - NAMUR

According to EU type approval certificate PTB 17 ATEX 2014 X (certificate number on the type label) and for all instruments with safety instruction 53829.

The classification as well as the respective standards are stated in the EU type approval certificate:

- EN IEC 60079-0: 2018
- EN 60079-11: 2012
- IEC 60079-26: 2021

Type of protection marking:

- II 1G Ex ia IIC T6 Ga
- or
- II 1/2G Ex ia IIC T6 Ga/Gb
- or
- II 2G Ex ia IIC T6 Gb

## 2 Important specification in the type code

VEGAWAVE WE61/63(\*).abcdefghi

Position		Feature	Description
ab	Approval	CX	ATEX II 1G, 1/2G, 2G Ex ia IIC T6 ... T1 Ga, Ga/Gb, Gb
		CK	ATEX II 1G, 1/2G, 2G Ex ia IIC T6 ... T1 Ga, Ga/Gb, Gb ATEX II 1D, 1/2D, 2D Ex ta, ta/tb, tb IIC T6 ... T1 Da, Da/Db, Db IP66
c	Version / Process temperature	A	Standard / -40 ... +150 °C
		B	with adapter / -40 ... +250 °C
		C	Detection of solids in water / -40 ... +150 °C
		D	Detection of solids in water / -40 ... +250 °C
		E	with Carbocer coating, less buildup, no corrosion/abrasion protection / -40 ... +150 °C
		F	with Carbocer coating, less buildup, no corrosion/abrasion protection / -40 ... +250 °C
de	Process fitting / Material	**	Process fittings acc. to industry standard
f	Electronics	Z	Two-wire (8/16 mA) 10 ... 36 V DC
		N	NAMUR signal

Position		Feature	Description
g	Housing / Protection	A	Aluminium single chamber / IP66/IP67
		K	Plastic single chamber / IP66/IP67
		8	Stainless steel single chamber (electropolished) / IP66/IP67
		V	Stainless steel single chamber (precision casting) / IP66/IP67
h	Cable entry / Cable gland / Plug connection	M	M20 x 1.5 / without / without
		N	½ NPT / without / without
		*	Further suitable Cable gland and Plug connection
i	Additional equipment	X	

## VEGAWAVE WE62(\*).abcdefghi

Position		Feature	Description
ab	Approval	CX	ATEX II 1G, 1/2G, 2G Ex ia IIC T6 ... T1 Ga, Ga/Gb, Gb
		CK	ATEX II 1G, 1/2G, 2G Ex ia IIC T6 ... T1 Ga, Ga/Gb, Gb ATEX II 1D, 1/2D, 2D Ex ta, ta/tb, tb IIC T6 ... T1 Da, Da/Db, Db IP66
c	Version / Process temperature	T	Cable PUR / -20 ... +80 °C
		H	Cable FEP / -40 ... +150 °C
		C	Cable PUR detection of solids in water / -20 ... +80 °C
		E	Cable FEP detection of solids in water / -40 ... +100 °C
		K	Cable PUR with Carbocer coating, less buildup, no corrosion/abrasion protection / -20 ... +80 °C
		L	Cable FEP with Carbocer coating, less buildup, no corrosion/abrasion protection / -50 ... +150 °C
		M	Kabel PUR detection of solids in water with Carbocer coating, less buildup, no corrosion/abrasion protection / -20 ... +80 °C
N	Cabel FEP detection of solids in water with Carbocer coating, less buildup, no corrosion/abrasion protection / -40 ... +100 °C		
de	Process fitting / Material	**	Process fittings acc. to industry standard
f	Electronics	Z	Two-wire (8/16 mA) 10 ... 36 V DC
		N	NAMUR signal
g	Housing / Protection	A	Aluminium single chamber / IP66/IP67
		K	Plastic single chamber / IP66/IP67
		8	Stainless steel single chamber (electropolished) / IP66/IP67
		V	Stainless steel single chamber (precision casting) / IP66/IP67
h	Cable entry / Cable gland / Plug connection	M	M20 x 1.5 / without / without
		N	½ NPT / without / without
		*	Further suitable Cable gland and Plug connection
i	Additional equipment	X	

In the following, all above mentioned versions are called VEGAWAVE 61, 62, 63. If parts of these safety instructions refer only to certain versions, then these will be mentioned explicitly with their type code.

### 3 Different ignition protection types

The VEGAWAVE 61, 62, 63 can be either used in explosive dust atmospheres or in explosive gas atmospheres.

The operator must specify the selected ignition protection type before installation. The selected ignition protection must be determined by marking it firmly on the identification label of the type plate.

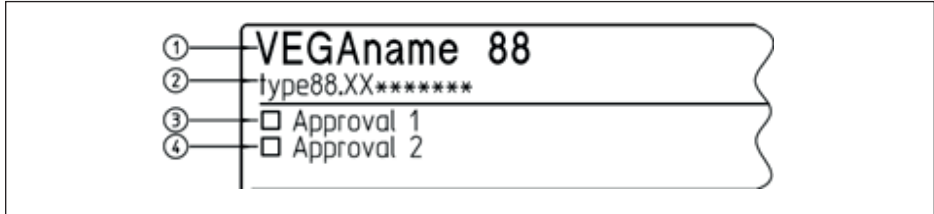

- 1 VEGAWAVE 61, 62, 63
- 2 Instrument version
- 3 Identification label: Approval in dust ignition protection type e. g. „Ex t“
- 4 Identification label: Approval in Gas ignition protection type e. g. „Ex i“, „Ex d“

### 4 General information

The VEGAWAVE 61, 62, 63 are used for level measurement in hazardous areas.

The VEGAWAVE 61, 62, 63 are suitable for applications in hazardous atmospheres of all combustible materials of explosion groups IIA, IIB and IIC.

The VEGAWAVE 61, 62, 63 are suitable for applications requiring category 1G (EPL Ga), 1/2G (EPL Ga/Gb) or 2G (EPL Gb) instruments.

### 5 Application area

#### Category 1G (EPL Ga instruments)

The VEGAWAVE 61, 62, 63 with the mechanical fixing element are installed in hazardous areas of zone 0 requiring category 1G (EPL Ga) instruments.





#### Category 1/2G (EPL Ga/Gb instruments)

The VEGAWAVE 61, 62, 63 with mechanical fixing element are installed in hazardous areas of zone 1 requiring instruments of category 2G (EPL Gb). The mechanical fixing element, process connection element is installed in the separating wall, which separates areas requiring instruments of category 2G (EPL Gb) or 1G (EPL Ga). The sensor measuring system is installed in hazardous areas of zone 0 requiring instruments of category 1G (EPL Ga).

#### Category 2G (EPL Gb instruments)

The VEGAWAVE 61, 62, 63 with the mechanical fixing element are installed in hazardous areas of zone 1 requiring category 2G (EPL Gb) instruments.

VEGA Instrument	2G (EPL Gb)	1/2G (EPL Ga/Gb)	1G (EPL Ga)
Ex Zone 2 			

VEGA Instrument	2G (EPL Gb)	1/2G (EPL Ga/Gb)	1G (EPL Ga)
Ex Zone 1 			
Ex Zone 0 			

## 6 Specific conditions of use ("X" identification)

The following overview is listing all special properties of VEGAWAVE 61, 62, 63, which make a labeling with the symbol "X" behind the certificate number necessary.

### Electrostatic charging (ESD)

You can find the details in chapter " *Electrostatic charging (ESD)*" of these safety instructions.

### Ambient temperature

You can find the details in chapter " *Thermal data*" of these safety instructions.

### Impact and friction sparks

The VEGAWAVE 61, 62, 63 in light metal versions (e.g. aluminium, titanium, zircon) must be mounted in such a way that sparks from impact and friction between light metals and steel (except stainless steel, if the presence of rust particles can be excluded) cannot occur.

### Non-grounded, metallic parts

The resistance between aluminium housing to metal measuring point identification plate is  $> 10^9$  Ohm.

The measuring point identification label must be connected to the earth connection using the accessories supplied. To ensure that this connection is always present, it must be checked at regular intervals.

The capacitance of the metal measuring point identification label (not grounded) was measured as follows:

Measurement loop identification label	Capacitance
45 x 23 mm (standard)	21 pF
100 x 30 mm	52 pF
73 x 47 mm	61 pF

### Media resistance

The wetted materials must be resistant against the measured media.

The min. fatigue strength of the vibrating element is  $8.8 \times 10^{11}$  load changes with a max. amplitude of 222  $\mu\text{m}$ . The lifetime is minimum 20 years.

### Locking mechanism of housing cover

With single-chamber housing versions, the lid must be screwed in to the stop and secured with the locking device before setup and use of VEGAWAVE 61, 62, 63 in hazardous atmospheres. It must be secured by unscrewing the cover locking screw to the stop.

**Single chamber housing**

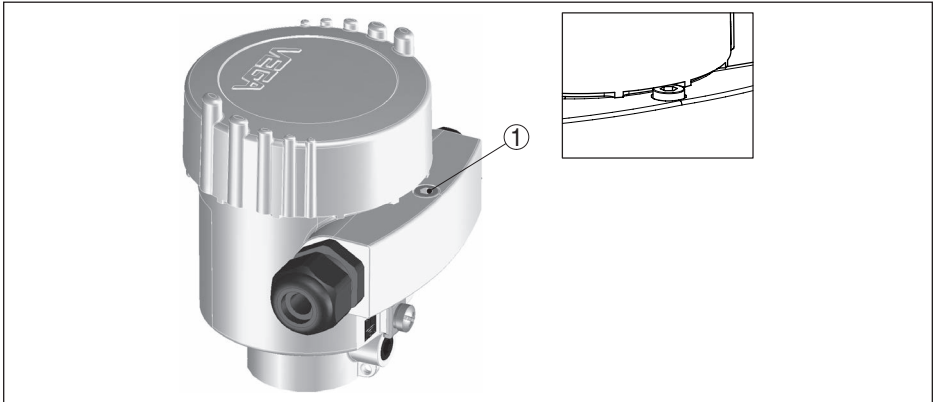

1 Locking screw of the lid

**7 Important information for mounting and maintenance**

**General instructions**

The following requirements must be fulfilled for mounting, electrical installation, setup and maintenance of the instrument:

- The staff must be qualified according the respective tasks
- The staff must be trained in explosion protection
- The staff must be familiar with the respectively valid regulations, e.g. planning and installation acc. to IEC/EN 60079-14
- Make sure when working on the instrument (mounting, installation, maintenance) that there is no explosive atmosphere present, the supply circuits should be voltage-free, if possible.
- The instrument has to be mounted according to the manufacturer specifications, the EU type approval certificate and the valid regulations and standards
- Modifications on the instrument can influence the explosion protection and hence the safety, therefore repairs are not permitted to be conducted by the end user
- Modifications must only be carried out by employees authorized by VEGA company
- Use only approved spare parts
- Components for installation and connection not included in the approval documents are only permitted if these correspond technically to the latest standard mentioned on the cover sheet. They must be suitable for the application conditions and have a separate certificate. The special conditions of the components must be noted and if necessary, the components must be integrated in the type test. This applies also to the components already mentioned in the technical description.
- Vessel installations and probable flow must be taken into account

**Cable and wire entries**

- The VEGAWAVE 61, 62, 63 must be connected via suitable cable gland or conduit systems that are in conformity with the requirements of the type of protection and the IP protection and provided with a separate type approval certificate. When connecting VEGAWAVE 61, 62, 63 to conduit systems, the corresponding sealing facility must be connected directly to the housing.
- The red thread or/dust covers screwed in when the instruments are shipped (depending on the version) must be removed before setup and replaced by cable entries or closing screws suitable for the respective ignition protection type and IP protection.



- Note type and size of the thread: A label with the respective thread name is in the area of the respective thread
- Threads must have no damages
- Cable entries and closing screws should be mounted correctly and according to the safety instructions of the manufacturer to ensure the specified ignition protection type and IP protection rating. When using certified or suitable cable glands, closing screws or plug connections, it is absolutely necessary to note the corresponding certificates/documents. Supplied cable entries or closing screws meet these requirements.
- Unused openings must be closed with plugs suitable for the ignition protection type and IP protection. Supplied plugs meet these requirements.
- Cable or wire entries resp. the closing screws must be tightly screwed into the housing
- The connection cables resp. pipeline sealing facilities must be suitable for the application conditions (e.g. temperature range) of the application
- With surface temperatures > 70 °C, the cables must be suitable for the higher application conditions
- The connection cable of VEGAWAVE 61, 62, 63 has to be wired fix and in such a way that damages can be excluded.

## Mounting

Keep in mind for instrument mounting

- Mechanical damage on the instrument must be avoided
- Mechanical friction must be avoided
- Vessel installations and probable flow must be taken into account
- Process connections separating two areas of different Ex-zones must comply to valid regulations and standards and the protection rating must be in conformity to IEC/EN 60529
- Close the housing lid (s) up to the stop before starting operating, to ensure the IP protection rating specified on the type label
- Protect the lid against unauthorized opening by unscrewing the locking screw up to the stop. With double chamber housing, you have to protect both lids.

## Maintenance

To ensure the functionality of the device, periodic visual inspection is recommended for:

- Secure mounting
- No mechanical damages or corrosion
- Worn or otherwise damaged cables
- No loose connections of the line connections, equipotential bonding connections
- Correct and clearly marked cable connections

The parts of the VEGAWAVE 61, 62, 63 being in contact with flammable media during operation must be included in the periodic overpressure test of the plant.

## Intrinsic safety "i"

- Valid regulations for connection of intrinsically safe circuits, e.g. proof of intrinsic safety according to IEC/EN 60079-14 must be observed
- The instrument is only suitable for connection to certified, intrinsically safe instruments
- When connecting a circuit with protection level Ex ib, the device, the sensor meas. system of the device must no more be used in hazardous areas of zone 0.
- When connecting an intrinsically safe instruments with classification mark Ex ia to a circuit with protection level Ex ib, then the classification mark of the instrument changes to Ex ib. After the use as instrument with Ex ib power supply, the instrument must no more be used in circuits with protection level Ex ia
- When connecting an intrinsically safe instrument to a non-intrinsically safe circuit, the instrument must be no longer used in intrinsically safe circuits

- With surface temperatures > 70 °C, the cables must be suitable for the higher application conditions

## 8 Safe operating mode

### General operating conditions

- Do not operate the instrument outside the electrical, thermal and mechanical specifications of the manufacturer
- Use the instrument only in media against which the wetted parts are sufficiently resistant
- Note the relation between process temperature on the sensor/antenna and the permissible ambient temperature on the electronics housing. For permissible temperatures, see the respective temperature tables. See chapter " *Thermal data*".
- If necessary, a suitable overvoltage arrester can be connected in front of the VEGAWAVE 61, 62, 63
- For assessment and reduction of the explosion risk, valid standards such as for example ISO/EN 1127-1 must be taken into account

## 9 Instructions for zone 0, zone 0/1 applications

In hazardous areas, the instrument, sensor measuring system in zone 0 should only be operated under atmospheric conditions:

- Temperature: -20 ... +60 °C.
- Pressure: 80 ... 110 kPa (0.8 ... 1.1 bar)
- Air with normal oxygen content, normally 21 %

The operator must ensure that the medium temperature in zone 0 is not higher than 80 % of the self-ignition temperature of the concerned medium (in °C) and does not exceed the max. permissible flange temperature depending on the temperature class. The parts of the sensor which during operation are in contact with flammable products, must be integrated in the periodic overpressure test of the plant.

If no explosive mixtures or additional application conditions are certified resp. supplementary measures such as e.g. according to ISO/EN 1127-1 taken, then the instruments can be also operated according to the manufacturer specification outside atmospheric conditions.

If there is a risk of dangerous potential differences inside zone 0, then suitable measures for circuits in zone 0 must be taken, e.g. according to the requirements of IEC/EN 60079-14.

Process fittings between two explosion protection areas require category 1G (EPL Ga) and less endangered areas must show a tightness in accordance with protection rating IP67 acc. to IEC/EN 60529.

## 10 Potential equalization/Grounding

- Integrate the instruments into the local potential equalisation, e.g. via the internal or external earth terminal
- The potential equalization terminal must be secured against loosening and twisting
- If grounding of the cable screening is necessary, this must be carried out acc. to the valid standards and regulations, e.g. acc. to IEC/EN 60079-14
- The intrinsically safe input and the intrinsically safe output circuits are ground-free. The voltage resistance against ground is min. 500 Veff.

## 11 Electrostatic charging (ESD)

In case of instrument versions with electrostatically chargeable plastic parts, the danger of electro-

static charging and discharging must be taken into account!

The following parts can charge and discharge:

- Lacquered housing version or alternative special lacquering
- Plastic housing, plastic housing parts
- Metal housing with inspection window
- Plastic process fittings
- Plastic-coated process fittings and/or plastic-coated sensors
- Connection cable for separate versions
- Type label
- Isolated metallic labels (measuring point identification plate)

Take note in case of danger of electrostatic charges:

- Avoid friction on the surfaces
- Do not dry clean the surfaces

The instruments must be mounted/installed in such a way that the following can be ruled out:

- electrostatic charges during operation, maintenance and cleaning.
- process-related electrostatic charges, e.g. by measuring media flowing past

The warning label indicates danger:

WARNING - POTENTIAL ELECTROSTATIC CHARGING HAZARD - SEE INSTRUCTIONS

## 12 Electrical data

### Two-wire electronics

<b>Supply and signal circuit:</b>	
Terminals 1[+], 2[-] in "Ex i" electronics compartment, with double chamber housing version in the connection compartment	In type of protection intrinsic safety Ex ia IIC/IIB For connection to a certified, intrinsically safe circuit. Maximum values: ● $U_i = 30 \text{ V}$ ● $I_i = 131 \text{ mA}$ ● $P_i = 983 \text{ mW}$ $C_i$ negligible or in the version with fixed mounted connection cable, Type series WE6*(*)..CX***Z3/5/9**, $C_{i\text{wire/wire}} = 58 \text{ pF/m}$ , $C_{i\text{wire/screen}} = 270 \text{ pF/m}$ , $L_i \leq 5 \mu\text{H}$ or in the version with fixed mounted connection cable, type series WE6*(*)..CX***Z3/5/9**, $L_i = 0.55 \mu\text{H/m}$ .
The intrinsically safe circuits are electrically separated from parts which can be grounded. The metallic parts of VEGAWAVE 61, 62, 63 are electrically connected with the earth terminals. For applications requiring instruments of category 1G or 1/2G, the intrinsically safe power supply and signal circuit must be in conformity with protection class ia. For applications requiring instruments of category 1G or 1/2G the VEGAWAVE 61, 62, 63 is preferably connected to appropriate instruments with electrically isolated intrinsically safe circuits. For applications requiring instruments of category 2G, the intrinsically safe power supply and signal circuit can correspond to protection class ia or ib. For connection to a circuit with protection class ib, the ignition protection type identification is Ex ib IIC T6.	

## Namur electronics

Supply and signal circuit:	
Terminals 1[+], 2[-] in "Ex i" electronics compartment, with double chamber housing version in the connection compartment	<p>In type of protection intrinsic safety Ex ia IIC/IIB For connection to a certified, intrinsically safe circuit. Maximum values:</p> <ul style="list-style-type: none"> <li>● <math>U_i = 20\text{ V}</math></li> <li>● <math>I_i = 103\text{ mA}</math></li> <li>● <math>P_i = 516\text{ mW}</math></li> </ul> <p><math>C_i</math> negligible or in the version with fixed mounted connection cable, Type series WE6*(*)..CX***N3/5**, <math>C_{i\text{wire/wire}} = 58\text{ pF/m}</math>, <math>C_{i\text{wire/screen}} = 270\text{ pF/m}</math>, <math>L_i \leq 5\text{ }\mu\text{H}</math> or in the version with fixed mounted connection cable, type series WE6*(*)..CX***N3/5**, <math>L_i = 0.55\text{ }\mu\text{H/m}</math>.</p>
<p>The intrinsically safe circuits are electrically separated from parts which can be grounded. The metallic parts of VEGAWAVE 61, 62, 63 are electrically connected with the earth terminals. For applications requiring instruments of category 1G or 1/2G, the intrinsically safe power supply and signal circuit must be in conformity with protection class ia. For applications requiring instruments of category 1G or 1/2G the VEGAWAVE 61, 62, 63 is preferably connected to appropriate instruments with electrically isolated intrinsically safe circuits. For applications requiring instruments of category 2G, the intrinsically safe power supply and signal circuit can correspond to protection class ia or ib. For connection to a circuit with protection class ib, the ignition protection type identification is Ex ib IIC T6.</p>	

## 13 Thermal data

The max. permissible ambient temperatures depending on the temperature class are specified in the following table.

### Two-wire electronics

#### Category 1G instruments

Temperature class	Permissible ambient temperature on the sensor and electronics
T6, T5, T4, T3, T2, T1	-20 ... +60 °C

The application conditions during operation without explosive mixtures are mentioned in the operating instructions manuals.

#### Category 1/2G instruments

Temperature class	Ambient temperature on the electronics	Ambient temperature on the sensor VEGAWAVE 62	Permissible ambient temperature on the sensor without temperature adapter VEGAWAVE 61/63	Permissible ambient temperature on the sensor with temperature adapter VEGAWAVE 61/63
T6	-40 ... +55 °C	-20 ... +60 °C	-50 ... +85 °C	-50 ... +85 °C
T5	-40 ... +70 °C	-20 ... +60 °C	-50 ... +100 °C	-50 ... +100 °C
T4	-40 ... +80 °C	-20 ... +60 °C	-50 ... +135 °C	-50 ... +135 °C

Temperature class	Ambient temperature on the electronics	Ambient temperature on the sensor VEGAWAVE 62	Permissible ambient temperature on the sensor without temperature adapter VEGAWAVE 61/63	Permissible ambient temperature on the sensor with temperature adapter VEGAWAVE 61/63
T3	-40 ... +80 °C	-20 ... +60 °C	-50 ... +150 °C	-50 ... +200 °C
T2, T1	-40 ... +80 °C	-20 ... +60 °C	-50 ... +150 °C	-50 ... +250 °C

If the sensors of VEGAWAVE 61, 62, 63 are operated at temperatures higher than those specified in the above table, please make sure through appropriate measures that there is no danger of ignition from the hot surfaces. The max. permissible temperature on the electronics/housing should not exceed the values specified in the above table. The application conditions when operating in the absence of explosive mixtures can be found in the manufacturer information.

When the sensor of VEGAWAVE 61 and 63 is operated in hazardous atmospheres of zone 0, there is no danger of ignition if it is operated under non-atmospheric pressures from -1 to 16 bar and temperatures according to the temperature classes T6 ... T1.

### Category 2G instruments

Temperature class	Ambient temperature on the electronics	Ambient temperature on the sensor VEGAWAVE 62	Permissible ambient temperature on the sensor without temperature adapter VEGAWAVE 61/63	Permissible ambient temperature on the sensor with temperature adapter VEGAWAVE 61/63
T6	-40 ... +55 °C	-20 ... +70 °C	-50 ... +85 °C	-50 ... +85 °C
T5	-40 ... +70 °C	-20 ... +80 °C	-50 ... +100 °C	-50 ... +100 °C
T4	-40 ... +80 °C	-20 ... +80 °C	-50 ... +135 °C	-50 ... +135 °C
T3	-40 ... +80 °C	-20 ... +80 °C	-50 ... +150 °C	-50 ... +200 °C
T2, T1	-40 ... +80 °C	-20 ... +80 °C	-50 ... +150 °C	-50 ... +250 °C

If the VEGAWAVE 61, 62, 63 are operated at temperatures higher than those specified in the above table, please make sure through appropriate measures that there is no danger of ignition from the hot surfaces. The maximum temperature on the electronics/housing should not exceed the values specified in the above table. The permissible operating temperatures and pressures are stated in the manufacturer information.

### Namur electronics

#### Category 1G instruments

Temperature class	Permissible ambient temperature on the sensor and electronics
T6, T5, T4, T3, T2, T1	-20 ... +60 °C

The application conditions during operation without explosive mixtures are mentioned in the operating instructions manuals.

## Category 1/2G instruments

Temperature class	Ambient temperature on the electronics	Ambient temperature on the sensor VEGAWAVE 62	Permissible ambient temperature on the sensor without temperature adapter VEGAWAVE 61/63	Permissible ambient temperature on the sensor with temperature adapter VEGAWAVE 61/63
T6	-40 ... +61 °C	-20 ... +60 °C	-50 ... +85 °C	-50 ... +85 °C
T5	-40 ... +76 °C	-20 ... +60 °C	-50 ... +100 °C	-50 ... +100 °C
T4	-40 ... +80 °C	-20 ... +60 °C	-50 ... +135 °C	-50 ... +135 °C
T3	-40 ... +80 °C	-20 ... +60 °C	-50 ... +150 °C	-50 ... +200 °C
T2, T1	-40 ... +80 °C	-20 ... +60 °C	-50 ... +150 °C	-50 ... +250 °C

If the sensors of VEGAWAVE 61, 62, 63 are operated at temperatures higher than those specified in the above table, please make sure through appropriate measures that there is no danger of ignition from the hot surfaces. The max. permissible temperature on the electronics/housing should not exceed the values specified in the above table. The application conditions when operating in the absence of explosive mixtures can be found in the manufacturer information.

When the sensor of VEGAWAVE 61 and 63 is operated in hazardous atmospheres of zone 0, there is no danger of ignition if it is operated under non-atmospheric pressures from -1 to 16 bar and temperatures according to the temperature classes T6 ... T1.

## Category 2G instruments

Temperature class	Ambient temperature on the electronics	Ambient temperature on the sensor VEGAWAVE 62	Permissible ambient temperature on the sensor without temperature adapter VEGAWAVE 61/63	Permissible ambient temperature on the sensor with temperature adapter VEGAWAVE 61/63
T6	-40 ... +61 °C	-20 ... +70 °C	-50 ... +85 °C	-50 ... +85 °C
T5	-40 ... +76 °C	-20 ... +80 °C	-50 ... +100 °C	-50 ... +100 °C
T4	-40 ... +80 °C	-20 ... +80 °C	-50 ... +135 °C	-50 ... +135 °C
T3	-40 ... +80 °C	-20 ... +80 °C	-50 ... +150 °C	-50 ... +200 °C
T2, T1	-40 ... +80 °C	-20 ... +80 °C	-50 ... +150 °C	-50 ... +250 °C

If the VEGAWAVE 61, 62, 63 are operated at temperatures higher than those specified in the above table, please make sure through appropriate measures that there is no danger of ignition from the hot surfaces. The maximum temperature on the electronics/housing should not exceed the values specified in the above table. The permissible operating temperatures and pressures are stated in the manufacturer information.

## Permissible process pressure

### Category 1G instruments

For temperatures on the sensor according to the temperature classes T6 ... T1, pressures under atmospheric conditions of 0.8 to 1.1 bar are permissible.

### Category 1/2G instruments

If VEGAWAVE 61 and 63 are used as category 1/2G instruments, pressures from -1 bis 16 bar according to temperature classes T6 ... T1 are permitted also in the version with lock fitting (ARV-

WE63.2\*).

When the sensor of VEGAWAVE 61 and 63 is operated in hazardous atmospheres of zone 0, there is no danger of ignition if it is operated under non-atmospheric pressures from -1 to 16 bar and temperatures according to the temperature classes T6 ... T1.

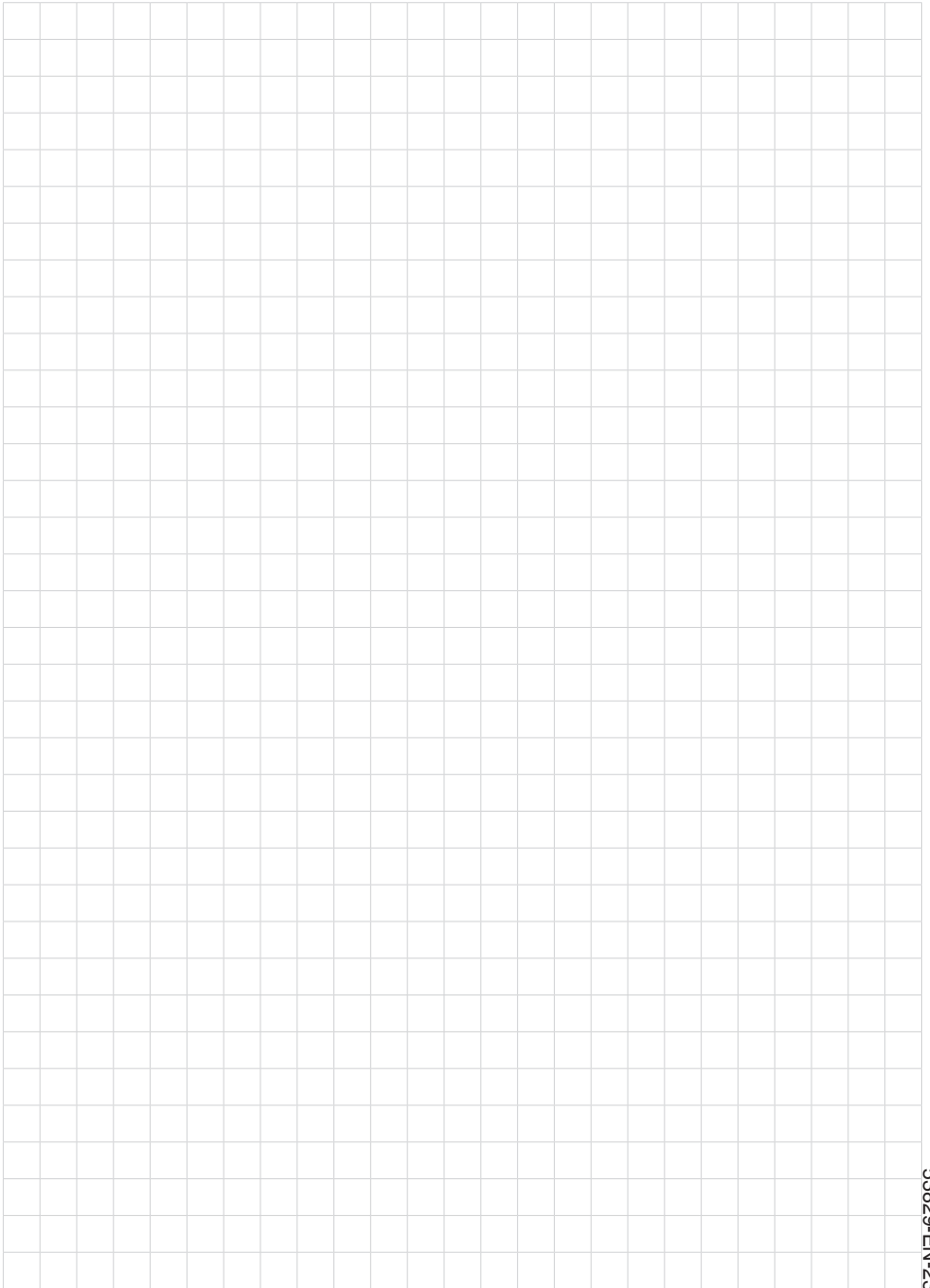

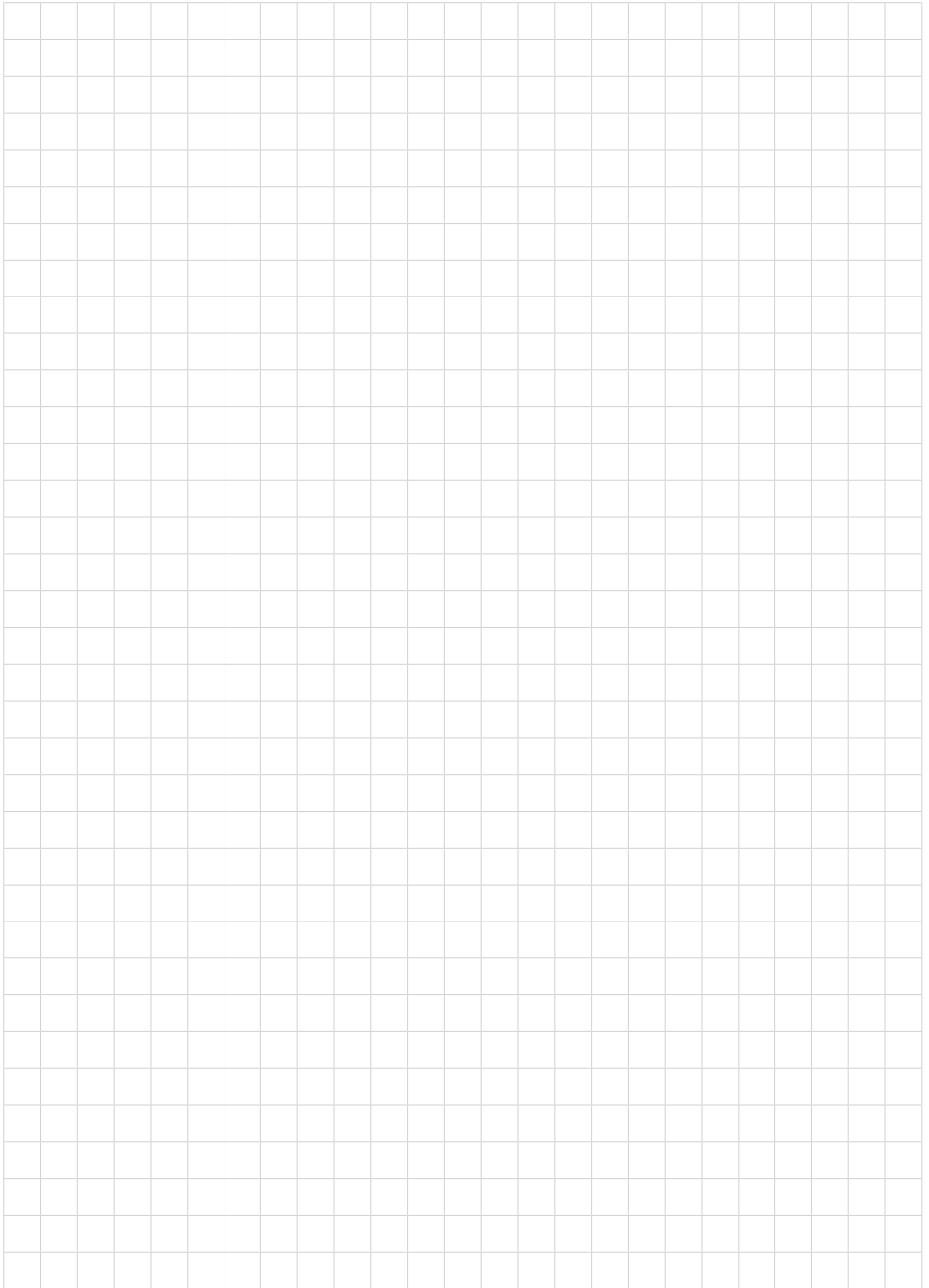

A large grid of graph paper for taking notes, consisting of 20 columns and 30 rows of small squares.

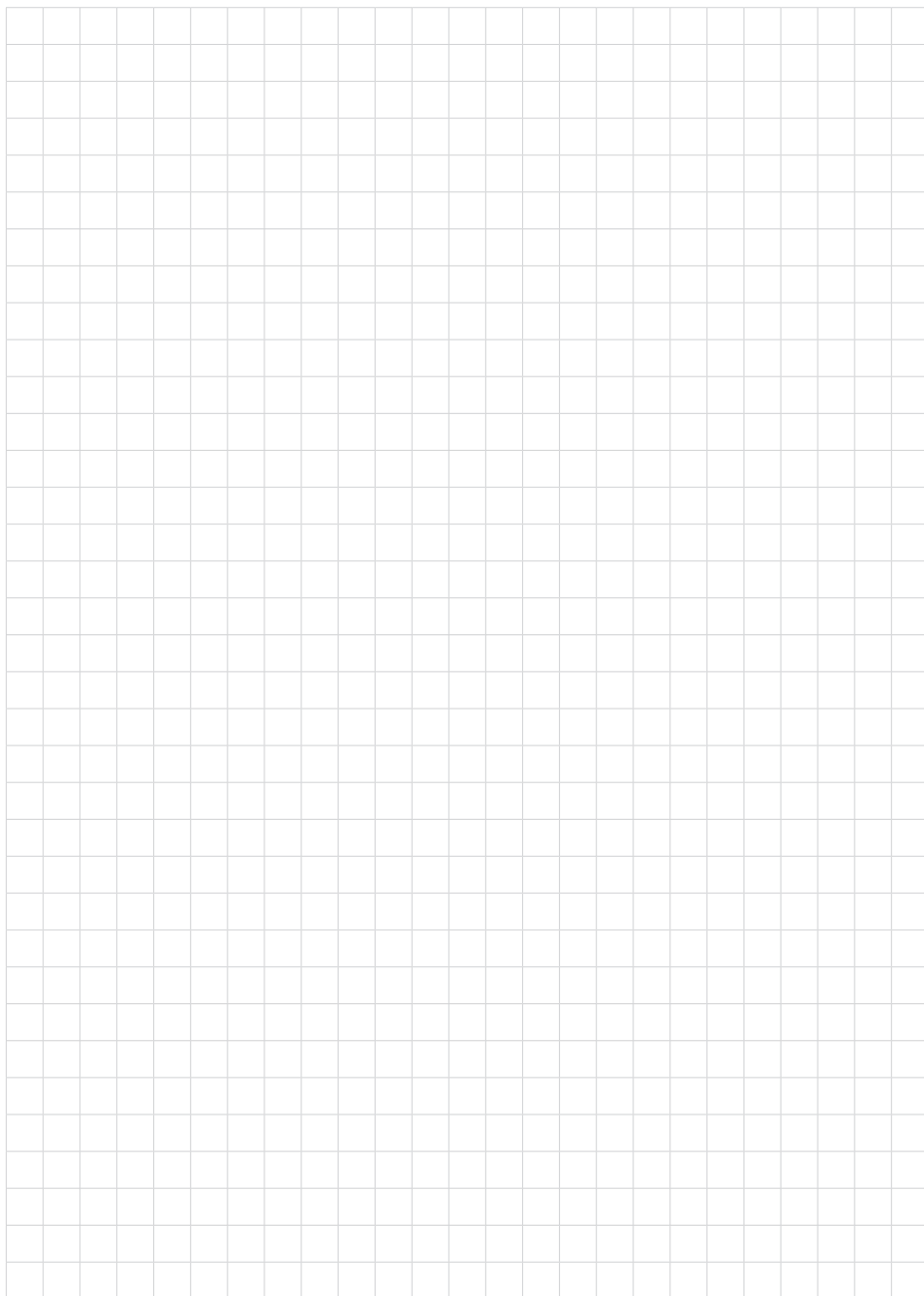



Printing date:

**VEGA**

All statements concerning scope of delivery, application, practical use and operating conditions of the sensors and processing systems correspond to the information available at the time of printing.

Subject to change without prior notice

© VEGA Grieshaber KG, Schiltach/Germany 2023



53829-EN-230316

VEGA Grieshaber KG  
Am Hohenstein 113  
77761 Schiltach  
Germany

Phone +49 7836 50-0  
E-mail: [info.de@vega.com](mailto:info.de@vega.com)  
[www.vega.com](http://www.vega.com)