

Quick setup guide

Ultrasonic sensor for continuous level measurement

VEGASON 61

Two-wire 4 ... 20 mA/HART



Document ID: 51852



VEGA

Contents

1 For your safety	3
1.1 Authorised personnel	3
1.2 Appropriate use.....	3
1.3 Warning about incorrect use.....	3
1.4 General safety instructions	3
1.5 Conformity.....	3
1.6 NAMUR recommendations	4
1.7 Environmental instructions	4
2 Product description	5
2.1 Configuration.....	5
3 Mounting	6
3.1 Mounting instructions	6
4 Connecting to power supply.....	7
4.1 Connection procedure.....	7
4.2 Wiring plan, single chamber housing.....	8
4.3 Wiring plan, double chamber housing	8
5 Set up with the display and adjustment module PLICSCOM	9
5.1 Insert display and adjustment module	9
5.2 Setup steps	9
5.3 Menu schematic.....	12
6 Set up with smartphone/tablet, PC/notebook via Bluetooth.....	15
6.1 Preparations.....	15
6.2 Connecting.....	17
6.3 Sensor parameter adjustment.....	17
7 Supplement	19
7.1 Technical data	19



Information:

This quick setup guide enables quick setup and commissioning of your instrument.

You can find supplementary information in the corresponding, more detailed Operating Instructions Manual as well as the Safety Manual that comes with instruments with SIL qualification. These manuals are available on our homepage.

**Operating instructions VEGASON 61 - Two-wire 4 ... 20 mA/
HART: Document-ID 28775**

Editing status of the quick setup guide: 2023-10-24

1 For your safety

1.1 Authorised personnel

All operations described in this documentation must be carried out only by trained and authorized personnel.

During work on and with the device, the required personal protective equipment must always be worn.

1.2 Appropriate use

VEGASON 61 is a sensor for continuous level measurement.

You can find detailed information about the area of application in chapter "*Product description*".

Operational reliability is ensured only if the instrument is properly used according to the specifications in the operating instructions manual as well as possible supplementary instructions.

1.3 Warning about incorrect use

Inappropriate or incorrect use of this product can give rise to application-specific hazards, e.g. vessel overfill through incorrect mounting or adjustment. Damage to property and persons or environmental contamination can result. Also, the protective characteristics of the instrument can be impaired.

1.4 General safety instructions

This is a state-of-the-art instrument complying with all prevailing regulations and directives. The instrument must only be operated in a technically flawless and reliable condition. The operating company is responsible for the trouble-free operation of the instrument. When measuring aggressive or corrosive media that can cause a dangerous situation if the instrument malfunctions, the operating company has to implement suitable measures to make sure the instrument is functioning properly.

The safety instructions in this operating instructions manual, the national installation standards as well as the valid safety regulations and accident prevention rules must be observed.

For safety and warranty reasons, any invasive work on the device beyond that described in the operating instructions manual may be carried out only by personnel authorised by us. Arbitrary conversions or modifications are explicitly forbidden. For safety reasons, only the accessory specified by us must be used.

To avoid any danger, the safety approval markings and safety tips on the device must also be observed.

1.5 Conformity

The device complies with the legal requirements of the applicable country-specific directives or technical regulations. We confirm conformity with the corresponding labelling.

The corresponding conformity declarations can be found on our homepage.

1.6 NAMUR recommendations

NAMUR is the automation technology user association in the process industry in Germany. The published NAMUR recommendations are accepted as the standard in field instrumentation.

The device fulfils the requirements of the following NAMUR recommendations:

- NE 21 – Electromagnetic compatibility of equipment
- NE 43 – Signal level for fault information from measuring transducers
- NE 53 – Compatibility of field devices and display/adjustment components

For further information see www.namur.de.

1.7 Environmental instructions

Protection of the environment is one of our most important duties. That is why we have introduced an environment management system with the goal of continuously improving company environmental protection. The environment management system is certified according to DIN EN ISO 14001.

Please help us fulfil this obligation by observing the environmental instructions in this manual:

- Chapter "*Packaging, transport and storage*"
- Chapter "*Disposal*"

2 Product description

2.1 Configuration

Type label

The type label contains the most important data for identification and use of the instrument:

- Instrument type
- Information about approvals
- Configuration information
- Technical data
- Serial number of the instrument
- QR code for device identification
- Numerical code for Bluetooth access (optional)
- Manufacturer information

Documents and software

To find order data, documents or software related to your device, you have the following options:

- Move to "www.vega.com" and enter in the search field the serial number of your instrument.
- Scan the QR code on the type label.
- Open the VEGA Tools app and enter the serial number under "**Documentation**".

3 Mounting

3.1 Mounting instructions

Reference plane for measuring range

The reference plane for the measuring range is the lower edge of the transducer.

Make sure that a minimum distance from the reference plane - the so-called dead zone, in which measurement is not possible - is maintained. The exact value of the dead zone is stated in chapter "Technical data".

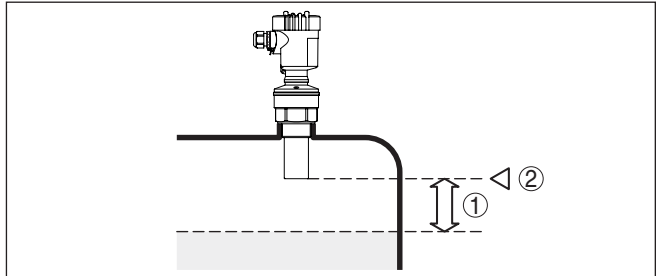

Fig. 1: Minimum distance to the max. level

- 1 blocking distance
- 2 Reference plane

Mounting

Mount the sensor at least 200 mm (7.874 in) away from the vessel wall.

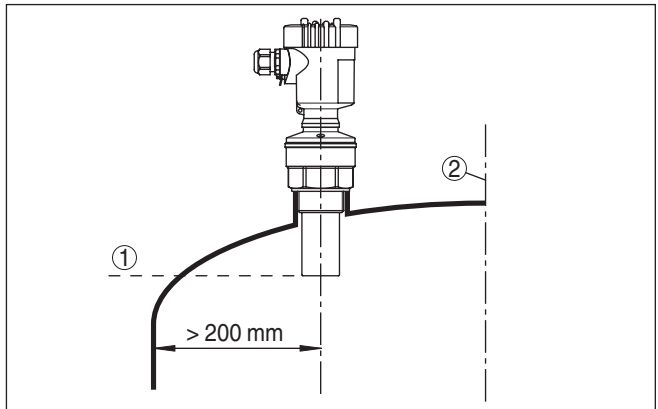

Fig. 2: Mounting on round vessel tops

- 1 Reference plane
- 2 Vessel center or symmetry axis

4 Connecting to power supply

4.1 Connection procedure

Proceed as follows:

1. Unscrew the housing lid
2. If a display and adjustment module is installed, remove it by turning it to the left
3. Loosen compression nut of the cable gland and remove blind plug
4. Remove approx. 10 cm (4 in) of the cable mantle, strip approx. 1 cm (0.4 in) of insulation from the ends of the individual wires
5. Insert the cable into the sensor through the cable entry
6. Lift the opening levers of the terminals with a screwdriver (see following illustration)
7. Insert the wire ends into the open terminals according to the wiring plan

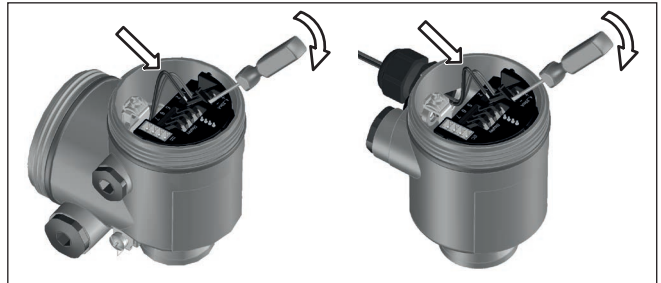

Fig. 3: Connection steps 6 and 7

8. Press down the opening levers of the terminals, you will hear the terminal spring closing
 9. Check the hold of the wires in the terminals by lightly pulling on them
 10. Connect the shielding to the internal ground terminal, connect the external ground terminal to potential equalisation
 11. Tighten the compression nut of the cable entry gland. The seal ring must completely encircle the cable
 12. Screw the housing lid back on
- The electrical connection is finished.

4.2 Wiring plan, single chamber housing

Wiring plan

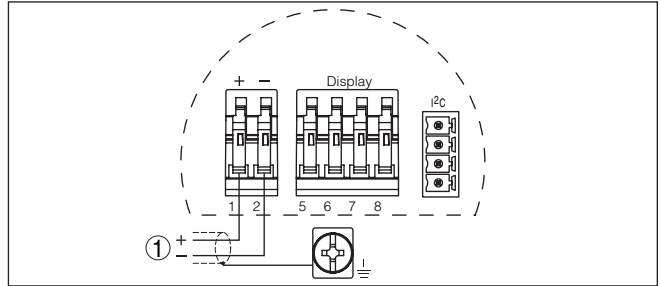

Fig. 4: Wiring plan - single chamber housing

1 Voltage supply, signal output

4.3 Wiring plan, double chamber housing

Wiring plan

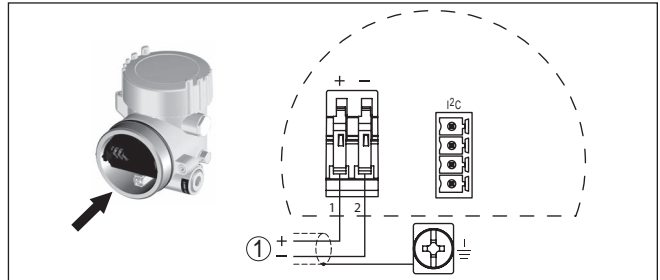

Fig. 5: Wiring plan - double chamber housing

1 Voltage supply, signal output

5 Set up with the display and adjustment module PLICSCOM

Mount/dismount display and adjustment module

5.1 Insert display and adjustment module

The display and adjustment module can be inserted into the sensor and removed again at any time. It is not necessary to interrupt the voltage supply.

Proceed as follows:

1. Unscrew the housing lid
2. Place the display and adjustment module in the desired position on the electronics (four positions in 90° offset can be selected) and turn to the right until it clicks into place.
3. Screw housing lid with inspection window tightly back on

Disassembly is carried out in reverse order.

The display and adjustment module is powered by the sensor, an additional connection is not necessary.



Fig. 6: Insert display and adjustment module in the single chamber housing



Note:

If you intend to retrofit the instrument with a display and adjustment module for continuous measured value indication, a higher lid with an inspection glass is required.

5.2 Setup steps

1. Go to the menu "Basic adjustment" via the display and adjustment module.

Set parameters

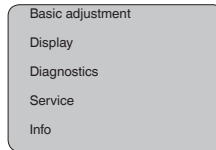

2. Carry out the adjustment in the menu items "*Min. adjustment*" and "*Max. adjustment*".

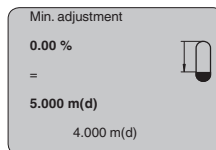
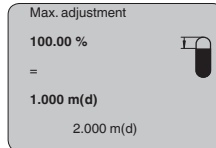

3. Select in the menu item "*Medium*" the medium of your application, for example "*Aqueous solution*".

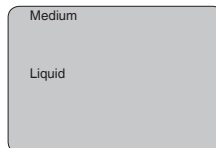

4. Select in the menu item "*Application*" the vessel, the application and the vessel form, for example, "*Storage tank*".

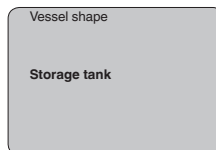

Parameter adjustment

The sensor measures the distance from the sensor to the medium surface. For indication of the real level, an allocation of the measured distance to the percentage height must be carried out.

The actual level is then calculated on the basis of these entered values. At the same time, the operating range of the sensor is limited from maximum range to the requested range.

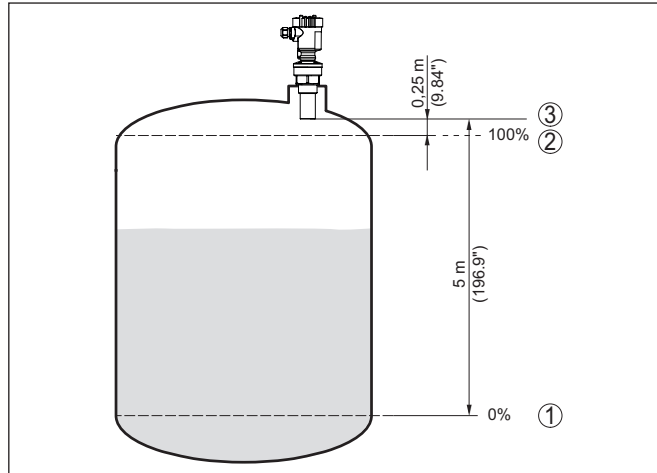

Fig. 7: Parameterisation example, Min./max. adjustment

- 1 Min. level = max. distance (depending on the sensor)
- 2 Max. level = min. distance (final value of the blocking distance, depending on the sensor)
- 3 Reference plane

The actual product level during this adjustment is not important, because the min./max. adjustment is always carried out without changing the product level. These settings can be made ahead of time without the instrument having to be installed.

Service - False signal suppression

High nozzles or vessel installations, such as e. g. struts or agitators as well as buildup and weld joints on the vessel walls, cause interfering reflections which can impair the measurement. A false echo storage detects and marks these false echoes, so that they are no longer taken into account for the level measurement. A false echo memory should be created with low level so that all potential interfering reflections will be detected.

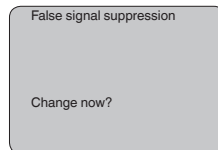

Proceed as follows:

1. Move from the measured value display to the main menu by pushing **[OK]**.
2. Select the menu item "Service" with **[->]** and confirm with **[OK]**. Now the menu item "False signal suppression" is displayed.
3. Confirm "False signal suppression - Change now" with **[OK]** and select in the below menu "Create new". Enter the actual distance from the sensor to the medium surface. All false signals in this

area are detected by the sensor and saved after confirming with **[OK]**.



Note:

Check the distance to the medium surface, because if an incorrect (too large) value is entered, the existing level will be saved as a false signal. The level would then no longer be detectable in this area.

5.3 Menu schematic



Information:

Depending on the version and application, the highlighted menu windows may not always be available.

Basic adjustment

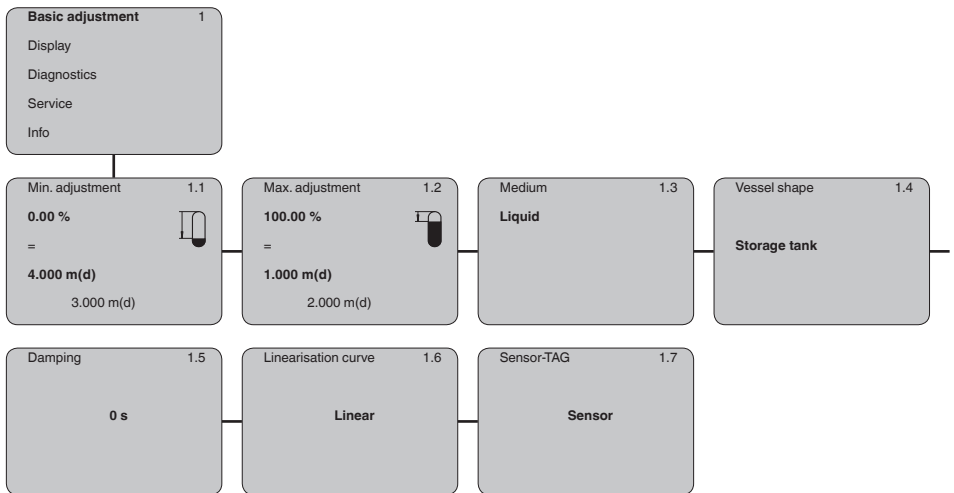

Display

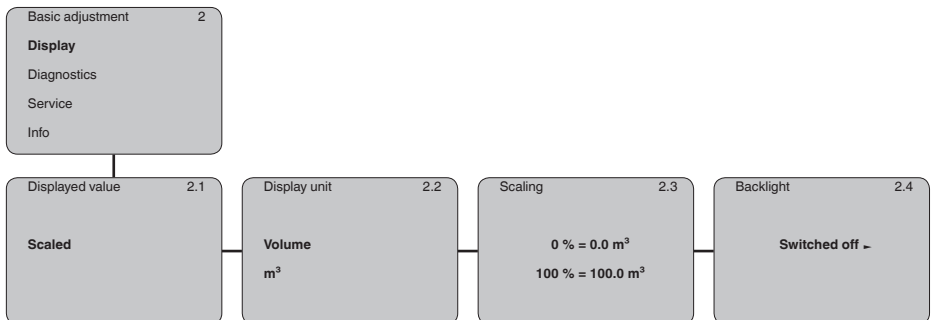

Diagnostics

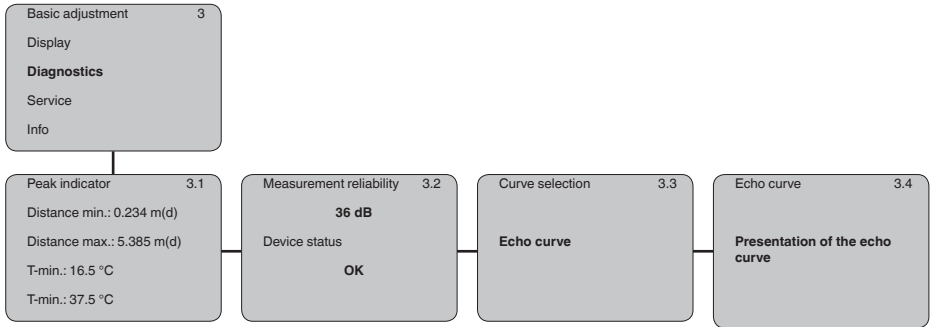

Service

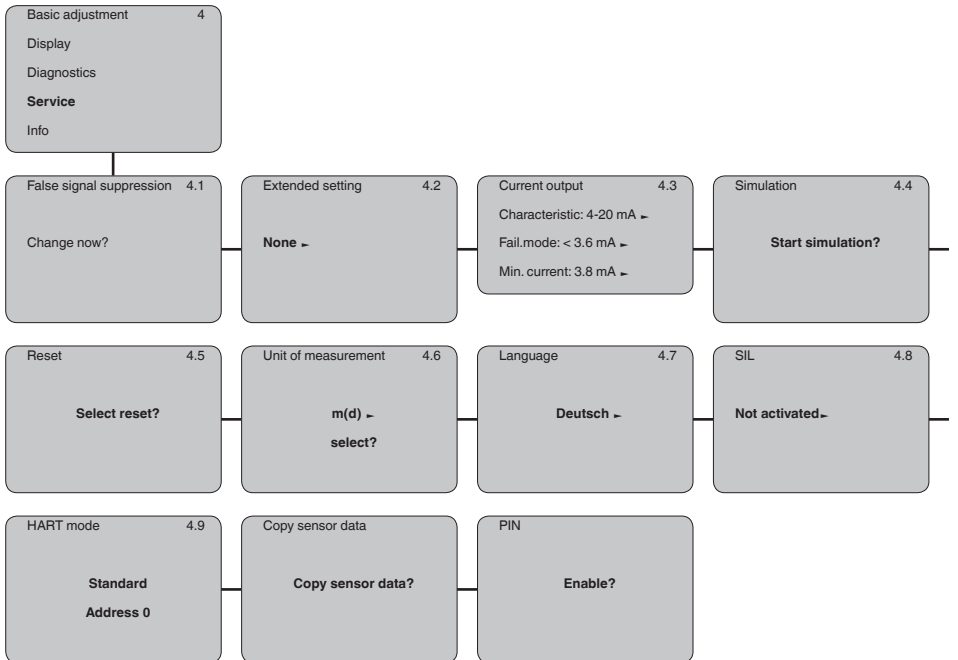

Info

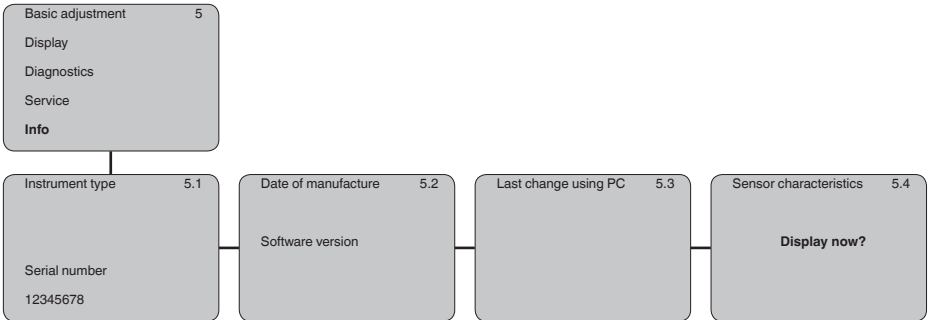

6 Set up with smartphone/tablet, PC/notebook via Bluetooth

6.1 Preparations

Activate Bluetooth

Make sure that the Bluetooth function of the display and adjustment module is activated. For this, the switch on the bottom side must be set to "On".

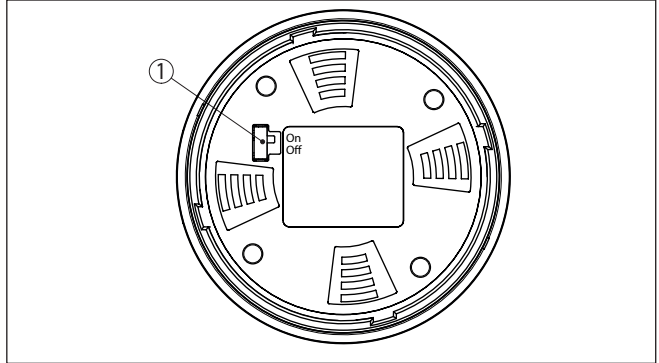

Fig. 8: Activate Bluetooth

1 Switch

On = Bluetooth active

Off = Bluetooth not active

Change sensor PIN

The security concept of Bluetooth operation absolutely requires that the default setting of the sensor PIN be changed. This prevents unauthorized access to the sensor.

The default setting of the sensor PIN is "0000". First of all you have to change the sensor PIN in the adjustment menu of the sensor, e.g. to "1111":

1. In the adjustment menu, go to "Service", "PIN":

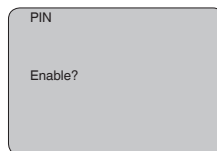
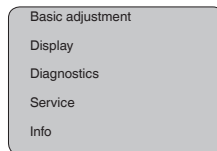

2. Change sensor PIN and confirm with "OK":

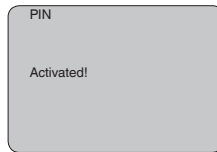
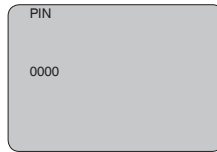

3. Deactivate sensor PIN and confirm with "OK":

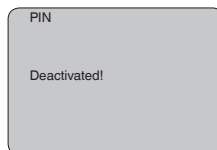
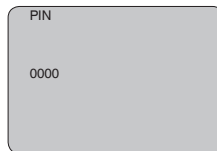
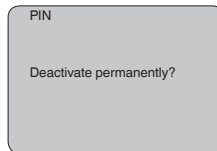

Sensor adjustment via the display/adjustment module or PACTware/DTM by means of VEGACONNECT is thus released again. For access (authentication) with Bluetooth, the changed PIN is still effective.

**Note:**

Bluetooth access can only be established if the current sensor PIN differs from the default setting "0000". It is possible both when the PIN is deactivated and when it is activated.

6.2 Connecting

Preparations

Smartphone/Tablet

Start the adjustment app and select the function "Setup". The smartphone/tablet searches automatically for Bluetooth-capable instruments in the area.

PC/Notebook

Start PACTware and the VEGA project assistant. Select the device search via Bluetooth and start the search function. The device automatically searches for Bluetooth-capable devices in the vicinity.

Connecting

The message "*Instrument search running*" is displayed. All devices found are listed in the operating window. The search is automatically continued continuously.

Select in the device list the requested device. The message "*Connecting*" is displayed.

Authenticate

For the first connection, the operating device and the sensor must authenticate each other. After successful authentication, the next connection functions without authentication.

For authentication, enter in the next menu window the 4-digit sensor PIN.

6.3 Sensor parameter adjustment

The sensor parameterization is carried out via the adjustment app on the smartphone/tablet or the DTM on the PC/notebook.

App view

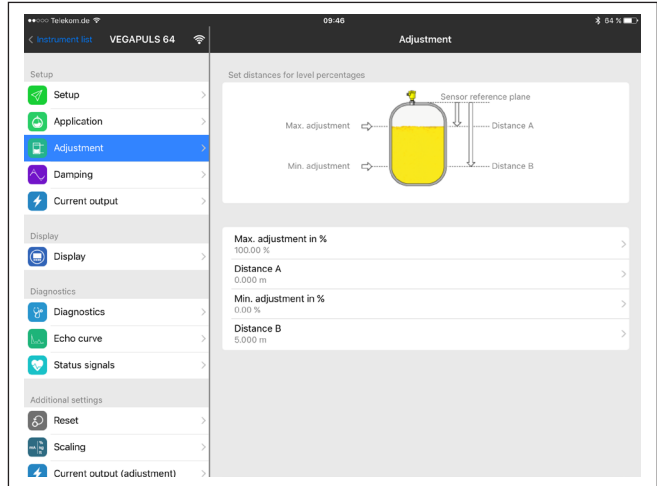

Fig. 9: Example of an app view - Setup sensor adjustment

7 Supplement

7.1 Technical data

Note for approved instruments

The technical data in the respective safety instructions which are included in delivery are valid for approved instruments (e.g. with Ex approval). These data can differ from the data listed herein, for example regarding the process conditions or the voltage supply.

All approval documents can be downloaded from our homepage.

Input variable

Measured variable	distance between lower edge of the transducer and medium surface
Measuring range	
– Liquids	up to 5 m (16.4 ft)
– Bulk solids	up to 2 m (6.562 ft)
blocking distance	0.25 m (0.82 ft)

Electromechanical data - version IP66/IP67 and IP66/IP68 (0.2 bar)

Options of the cable entry

– Cable entry	M20 x 1.5; ½ NPT
– Cable gland	M20 x 1.5; ½ NPT
– Blind plug	M20 x 1.5; ½ NPT
– Closing cap	½ NPT

Wire cross-section (spring-loaded terminals)

– Massive wire, stranded wire	0.2 ... 2.5 mm ² (AWG 24 ... 14)
– Stranded wire with end sleeve	0.2 ... 1.5 mm ² (AWG 24 ... 16)

Voltage supply

Operating voltage	14 ... 35 V DC
Operating voltage U_B with lighting switched on	20 ... 35 V DC
Permissible residual ripple	
– < 100 Hz	$U_{ss} < 1 V$
– 100 Hz ... 10 kHz	$U_{ss} < 10 mV$
Load resistor	
– Calculation	$(U_B - U_{min})/0.022 A$
– Example - with $U_B = 24 V DC$	$(24 V - 14 V)/0.022 A = 455 \Omega$

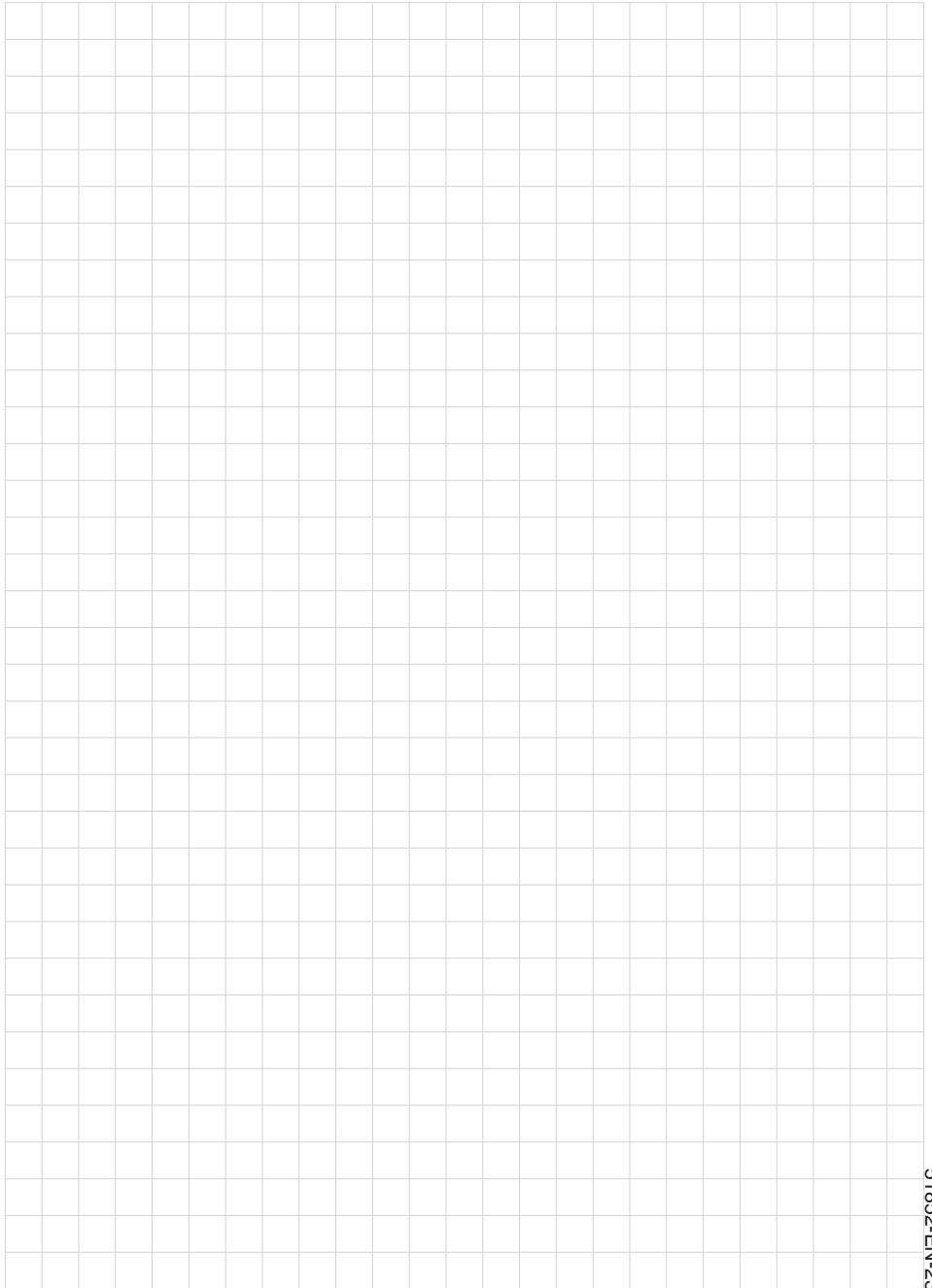



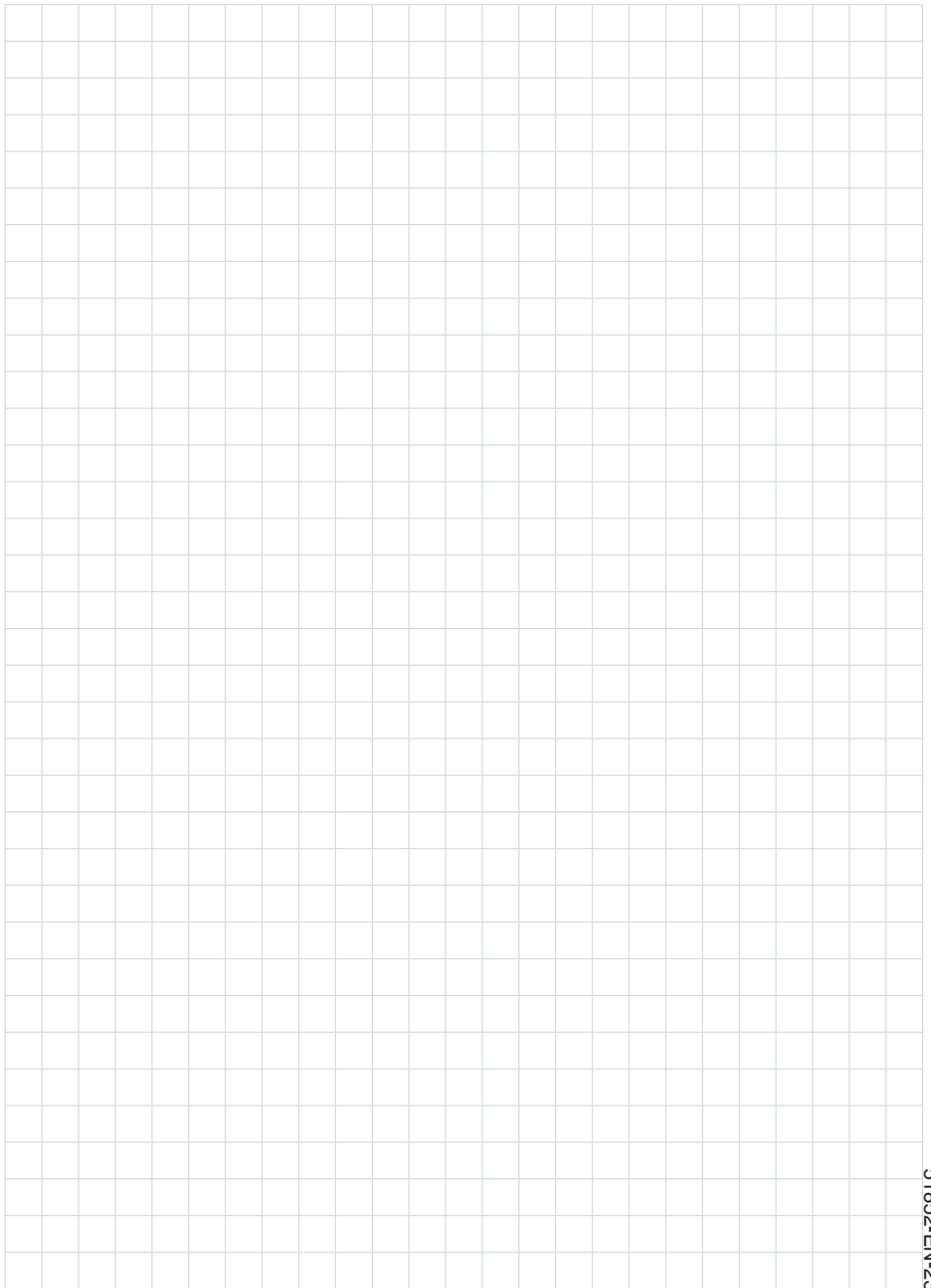

A large grid of graph paper for taking notes, consisting of 20 columns and 30 rows of small squares.

Printing date:

VEGA

All statements concerning scope of delivery, application, practical use and operating conditions of the sensors and processing systems correspond to the information available at the time of printing.

Subject to change without prior notice

© VEGA Grieshaber KG, Schiltach/Germany 2023



51852-EN-231026

VEGA Grieshaber KG
Am Hohenstein 113
77761 Schiltach
Germany

Phone +49 7836 50-0
E-mail: info.de@vega.com
www.vega.com